

2025

Wonday[®]
creative tools for school and business

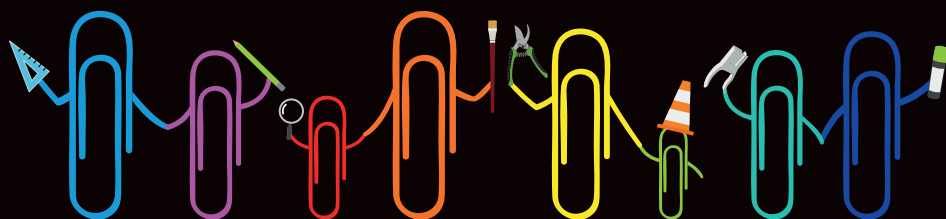

FOURNITURES
scolaires & de bureau

LOISIRS CRÉATIFS
activités manuelles

ÉQUIPEMENT
bricolage & manutention

SÉCURITÉ
des personnes & des biens

Wonday[®]

creative tools for school and business



wonday.com



WONDAY FAMILY

Wonday est une grande famille recomposée de plus de 50 collaborateurs. Le temps passe et notre détermination à faire grandir **Wonday** demeure intacte. Depuis maintenant sept ans, nous œuvrons chaque jour au bon développement de notre entreprise. Avec pour fil conducteur le volet développement durable présent dans toutes nos réflexions.

Qui dit développement, dit recrutement de nouvelles compétences et donc de nouvelles trombines. Nous sommes fiers de la relation nouée depuis de nombreuses années avec nos clients et avec nos fournisseurs. Nous sommes enthousiastes à l'idée de relever de nouveaux défis pour toujours mieux répondre aux attentes du marché. Sans relâche nous poursuivons notre progression dans un contexte économique et géopolitique complexe.

Au cœur d'une démarche écoresponsable et réfléchie face aux normes environnementales en vigueur, **Wonday** s'attache à vous accompagner dans vos besoins du quotidien.

Pour toujours mieux vous servir **Wonday** vous propose une large gamme de produits. En consultant ce catalogue, vous trouverez une sélection d'articles incontournables : fournitures scolaires et de bureau, activités manuelles et créatives, articles de manutention, de bricolage, de sécurité des personnes et des biens.

Fidèles à notre slogan « *Any tool for any day* »*.

Ensemble, affirmons nos positions et soyons acteurs de l'évolution de notre marché.

Famille Cargnelutti



* Complice de chaque journée



HAVE A WONDERFUL DAY !!



*Parce que nous croyons
qu'un trombone,
aussi petit soit-il,
peut changer le cours
d'une journée,
nous nous plions en huit
pour transformer
l'ordinaire en extraordinaire.*

*Parce que nous croyons que
la morosité
au bureau ou à l'école
n'est pas une fatalité,
nous cumulons les attentions
pour chasser les nuages
et vous offrir des couleurs.*



*Parce que nous croyons que
sourire ensemble
reste le meilleur moyen
d'enchanter le quotidien,
nous travaillons sérieusement
sans jamais nous
prendre au sérieux.
Nous nous engageons à faire
de chaque jour un jour meilleur.*



Wonday





ANY TOOL FOR ANY DAY*

*Wonday : * la marque complice de chaque journée*

L'expression d'une belle journée, avec pragmatisme et trombone attitude !

Notre ambition : devenir la marque préférée des consommateurs. Avec pas moins de 70 ans d'expérience cumulée, Wonday est le fruit du rapprochement des sociétés JPC Créations et Safetool. Notre belle famille recomposée veille avant tout à répondre aux attentes du marché. De la recherche de produits plus responsables à la création de nouvelles gammes, notre développement est constant.

L'icône de la marque – le trombone – illustre parfaitement l'esprit et l'ADN de la marque Wonday. Un outil simple, souple et créatif... comme nous ! Notre catalogue rassemble les outils indispensables de votre quotidien, vous retrouverez 5000 références incontournables à l'école, au bureau et à la maison.

ABONNEZ-VOUS !

Laissez-vous séduire par notre ADN et abonnez-vous à nos réseaux sociaux. Depuis sept ans, Wonday affiche sa personnalité et sa bonne humeur sur la toile. Octroyez-vous une récréation ou une pause-café ! Découvrez notre univers et vivez avec nous le Wonday's spirit*.

Notre souhait : faire connaître notre marque au fil des publications hebdomadaires qui mêlent les produits, l'esprit et les actualités de l'entreprise. À la fois pragmatique et pétillante, Wonday vous offre la possibilité d'accéder à des tutos (aides à la vente/SAV) mais aussi à des vidéos surprises multiples.

* L'esprit Wonday

Let's follow !**

Rejoignez la trombone communauté des Wonday Addicts.

** Suivez-nous !



wonday.com



WONDAY, PARTENAIRE MAJEUR DE L'ASM CLERMONT AUVERGNE



Savoir engager ses équipes et atteindre ses objectifs : voilà les maîtres mots communs à nos deux univers. Nous sommes heureux de pouvoir inscrire notre nom aux côtés de ces autres partenaires historiques du club. Retrouvez notre logo sur le maillot top 14 des joueurs auvergnats !

Chez Wonday, nous sommes un brin chauvin... nos origines auvergnates font parties de notre ADN et nous en sommes très fiers ! C'est donc naturellement que notre société s'est associée à l'ASM CA, faisant parti intégrante de la culture de la région. Nous croyons fortement aux valeurs partagées entre le sport et le monde de l'entreprise. Une collaboration allant au-delà d'un simple contrat de sponsoring, évoluant vers des relations mutuellement bénéfiques.

Nous soutenons l'ASM CA depuis plusieurs années :

SAISON 2022/2023
Partenaire Officiel



SAISON 2023/2024
Partenaire Majeur



SAISON 2024/2025
Partenariat Majeur

Une alliance stratégique permettant à notre marque Wonday de gagner en visibilité auprès de la Yellow Army – représentée par de fervents supporters, familles, partenaires, joueurs et staff. Un partenariat qui favorise l'implication communautaire et la promotion mutuelle. **PARCE QUE L'UNION FAIT LA FORCE !**

Au-delà de l'historique rugbystique de notre PDG – Monsieur Cyrille Cargnelutti – le rugby incarne pour nous un ensemble de valeurs contribuant à forger le caractère, insuffler la camaraderie et le respect au sein de notre Wonday Family.

Wonday® x



SOMMAIRE

Summary

Lexiques - Glossaries.....	10 & 231
----------------------------	----------

FOURNITURES - SUPPLIES

Gamme Green - Responsible products.....	11 - 16
Découper - Tailler - Cutting - Sharpening.....	19 - 38
Ciseaux - Taille-crayons - Machine à tailler - Scissors - Sharpeners - Desktop pencil sharpeners	
Agrafer - Perforer - Assembler - Stapling - Punching - Assembling.....	39 - 68
Agrafeuses - Ôte-agrafes - Perforateur - Adhésif - Dévidoir - Attaches - Pincés - Élastiques - Aimants	
Staplers - Staples - table remover - Punches - Tape - Tape dispensers - Paper clips - Binder clips - Rubber bands	
Coller - Corriger - Enseigner - Sticking - Correcting - Teaching.....	69 - 77
Colles - Correcteurs - Gommés - Ardoises - Glue - White corrections - Erasers - Slates	
Tracer - Mesurer - Drawing - Measuring.....	78 - 107
Compas - Traçage - Calculatrices - Compases - Drawing instruments - Calculators	
Activités scolaires - School activities.....	108 - 123
Globes - Loupes - Boussoles - Gourdes - Accessoires scolaires - Ecriture - Globes - Magnifiers - Compases - Bottles - School accessories - Writing	

LOISIRS CRÉATIFS - CREATIVE ACTIVITIES

Colorier - Peindre - Colouring - Painting.....	125 - 135
Coloriage - Tabliers & Matériel de peinture - Colouring activities - Painting aprons & equipment	
Activités manuelles et créatives - Manual and crafting activities.....	136 - 152
Papiers créatifs - Outils de découpe & Collage - Perforateurs déco - Creative papers - Cutting & gluing tools - Punchers	

ÉQUIPEMENT - FOURNITURE

Services généraux - General services.....	156 - 191
Porte-blocs - Chemises & Pochettes - Accessoires de bureau - Ergonomie au bureau - Equipements électriques - Clipboard - Filing - Desktop pencil sharpeners - Office accessories - Office ergonomics - Electrical equipment	
Bricoler - Jardiner - Bricoler - Jardiner.....	192 - 208
Cutters - Grattoirs - Outillage à main - Outils de mesure - Outils de jardin - Cutters - Scrapers - Hand tools - Measurement tools - Gardening tools	
Manutention - Manutention.....	209 - 229
Tabourets - Marchepieds - Escabeaux - Diabes - Chariots - Rolling stepstools - Stepstools - Stepladders - Hand trucks - Platform trolleys	

SÉCURITÉ - SECURITY

Secourir - Prévenir - Secourir - Prévenir.....	232 - 239
Trousse de secours - Armoires à pharmacie - Extincteurs - Signalisation - First aid kits - Medicine cabinets - Extinguishers - Signalisation	
Sécuriser - Détecter - Sécuriser - Détecter.....	242 - 282
Coffres-forts - Caisnes à monnaie - Monnayeurs - Gestion de la monnaie - Détection - Armoires à clés - Cadenas - Safes - Cash boxes - Coin trays - Currency management - Detection - Keys cabinets - Padlocks	
Index alphabétique - Alphabetical index.....	286 - 288
Index numérique - Numerical index.....	289 - 294

ON S'EMBALLE pour l'écoresponsabilité !

Nouveau look, nouvelle vie ! Non, nous ne sommes pas encore Cristina Cordula... mais nos produits ne manquent pas de style ! Depuis maintenant cinq ans, notre attention s'est particulièrement portée sur la forme et la matière de nos emballages afin d'être **plus écoresponsables**.

Wonday opte dans la mesure du possible pour de l'**écoconception**. Conscientes des axes d'amélioration possibles, nos équipes se sont fixées des objectifs : lutter contre le suremballage et bannir le plastique ! L'écoresponsabilité fait partie de nos sujets de prédilection. Notre volonté première est d'alléger nos packs et de favoriser le monomatériau (le tout carton) !



Dans la poursuite de cette démarche, nous sommes constamment en quête de **matériaux certifiés et labélisés FSC**. Vous retrouverez sur nos packagings le logo « Eco Pack » indiquant alors le pourcentage de matières recyclées associé à l'emballage du produit.

#1 METTEZ LE PAQUET !

SYSTÈME
D'ACCROCHE
INTÉGRÉ



100%
CARTON

#2 PRÉCIS, EFFICACE ET RESPONSABLE !

ZÉRO PVC



RÉDUCTION
DE MATIÈRE

100 %
CARTON



#3 VOIR LA VIE EN VERT !

100 %
CARTON



0 COQUE
PLASTIQUE

#4 FAIRE UN CARTON !

100 %
CARTON



RÉDUCTION
DE MATIÈRE

BON À SAVOIR

Good to know



NOUVEAUTÉ

Découvrez les vidéos de nos produits sur **notre compte Youtube** ! Sur la version interactive de ce catalogue, il suffit de cliquer sur l'icône « Play » pour accéder à des contenus exclusifs : tutos, vidéos de présentation, etc.

Pour la version interactive, rendez-vous sur : **calameo.com**

Discover our product videos **on Youtube** ! On the interactive version of this catalogue, just click on the « Play » icon to access exclusive content: tutorials, presentation videos, etc.

For the interactive version, go to: **calameo.com**



Nouveauté 2025
New 2025



Fabriqué en France
Made in France



Fabriqué en Europe
Made in Europe



Packaging écoresponsable
Eco-responsible packaging



Pochette en R-PP

Produit recyclé
Recycled product

MARQUES PARTENAIRES

Retrouvez tous les produits de nos partenaires sur fonds gris.



























BRANDS PARTNER

Find the products of our partners on grey backgrounds.



LEXIQUE

Glossary

PICTOGRAMMES / PICTOGRAM			
Unité de vente - Boîte carton Minimum quantity - Outer box	UV/PCB	Fabrication européenne Made in Europe	
Coloris Color		Lumineux Lighting	
Coloris assortis Assorted colours		Pointe marqueur Marker tip	
Lames bouts pointus Sharp-end blades		Stylo bille Roller pen	
Lames bouts ronds Round-end blades		Stylo plume Fountain pen	
Lames bouts mixtes Mixed blades		Crayons de couleur hexagonale Hexagonal coloured pencils	
Gaucher Left handed		Crayons de couleur triangulaire Triangular coloured pencils	
1 usage 1 use		Feutres ronds Rounded felt pens	
1 usage gros crayon 1 large pencil use		Feutres triangulaire Triangular felt pens	
2 usages 2 uses		Pointe fine Fine tip	
3 usages 3 uses		Pointe moyenne Medium tip	
Aimanté Magnetic		Pointe large Large tip	
Capacité d'agrafage - Stapling capacity Capacité perforation - Stapling capacity		Boutons plastique Plastic buttons	
Fabrication française Made in France		Boutons pression Press buttons	

MATIÈRES / MATERIAL			
Acrylonitrile Butadiène Styrène	ABS	Polyoxyméthylène	POM
Polypropylène à Orientation Biaxiale	BOPP	Polypropylène	PP
Éthylène-acétate de vinyle	EVA	Polystyrène	PS
Polyamide	PA	Polyuréthane	PU
Polytéréphtalate de butylène	PBT	Polychlorure de vinyle	PVC
Polycarbonate	PC	Styrène-acrylonitrile	SAN
Polyéthylène	PE	Élastomère thermoplastique	TPE
Polytéréphtalate d'éthylène	PET	Thermo-propylen rubber	TPR

Marques & modèles déposés - Registered model & trademark

Tous nos produits satisfont les normes en vigueur - All our products meet the current standards

Photos & coloris non contractuels - Photos and colours are not contractual

Jusqu'à épuisement des stocks - While supplies last

GAMME GREEN

Eco-friendly products

Parce que le vert est notre couleur préférée... nos équipes ont œuvré cette année à la construction d'une toute nouvelle Gamme Green. Ici, nous privilégions une conception et un choix d'articles plus respectueux de l'environnement. Wondou se veut plus responsable et intègre de plus en plus de matières recyclées dans ses produits. Laissez-vous surprendre par la green attitude !



NOUABLUE

Anneaux asymétriques ergonomiques en PP vierge à 75% et fibre de blé à 25% - 75% virgin PP and 25% wheat fiber ergonomic asymmetrical handles
Lames en acier inox trempé - Stainless steel blades
Double biseau - Double bevel blade
Couleur granulée - Granulated colour

REF.	TAILLE SIZE	CARACTÉRISTIQUES SPECIFICATIONS	CONDITIONNEMENT PACKING	UV/PCB
FCI213062	21 cm	PP Fibre de blé Wheat fiber	LS / Pegboardable	12/120
FCI173062	17 cm	PP Fibre de blé Wheat fiber	LS / Pegboardable	12/120
FCI133262	13 cm	PP Fibre de blé Wheat fiber	LS / Pegboardable	12/240



NOUAGREEN

Lames en acier inox trempé - Stainless steel blades
Double biseau - Double bevel blade
Anneaux asymétriques ergonomiques en PP et fibre de blé
PP and wheat fiber asymmetrical ergonomic handles
Ciseaux démontables et recyclables - Recyclable removable scissors

REF.	TAILLE SIZE	CARACTÉRISTIQUES SPECIFICATIONS	CONDITIONNEMENT PACKING	UV/PCB
FCI211962	21 cm	PP Fibre de blé Wheat fiber	LS / Pegboardable	10/120
FCI172162	17 cm	PP Fibre de blé Wheat fiber	LS / Pegboardable	10/120

UNI'VERT

Lames en acier inox trempé - Stainless steel blades
Anneaux asymétriques bi-matière (RPP - RTPR) - Asymmetrical soft grip handles (RPP-RTPR)

REF.	TAILLE SIZE	CARACTÉRISTIQUES SPECIFICATIONS	CONDITIONNEMENT PACKING	UV/PCB
FCI130481	13 cm	RPP / RTPR	Vrac / Bulk	24/360



GAMME GREEN

Eco-friendly products



Tube en R-PP



ON A LA PATATE !

BÂTONS DE COLLE D'ORIGINE VÉGÉTALE*

Vegetal glue sticks

Tube plastique PE/R-PP - PE/R-PP plastic tube

Colle blanche à base d'eau et d'amidon de pomme de terre - White glue made of water and potato starch

*Ce produit n'est pas un aliment et ne doit pas être ingéré. Éviter le contact avec les yeux. Pour les enfants, à utiliser en présence d'adultes. This product is not food and should not be ingested. Avoid contact with eyes. For children, use in the supervision of an adult.

REF.	TAILLE SIZE	CARACTÉRISTIQUES SPECIFICATIONS	CONDITIONNEMENT PACKING	UV/PCB
FCL400113	40 g	61% R-PP	Boîte / Box	12/144
FCL200113	20 g	61% R-PP	Boîte / Box	12/288
FCL100113	10 g	56% R-PP	Boîte / Box	24/576



R-ABS



R-PS

TAILLE-CRAYONS RECYCLÉ

Taille-crayons 1 usage - 1-Hole pencil sharpener

Pour des crayons de Ø 6 à Ø 12 mm - For Ø 6 to Ø 12 mm pencils

Réserve clipsée - Clip-on bin

Corps plastique recyclé - Recycled plastic body

Taille-crayons plastique - Plastic sharpener

Livré en boîte de 24 pcs - Delivered in box of 24 pcs

REF.	TAILLE/ SIZE	CARACTÉRISTIQUES SPECIFICATIONS	CONDITIONNEMENT PACKING	UV/ PCB
FTC150483	Ø 6/12 mm	R-PS R-ABS	Vrac / Bulk	24/144



R-PET



SURLIGNEURS

Highlighters



Coloris fluo - Neon colours
Corps & capuchon en R-PET - R-PET body & cap
Pointe biseautée - Bevelled tip
Trait de 1 à 4 mm - 1 to 4 mm width

REF.	QUANTITÉ QUANTITY	CARACTÉRISTIQUES SPECIFICATIONS	CONDITIONNEMENT PACKING	LIV/PCB
FEC400403	x 10	R-PET	Vrac / Bulk	10/240
FEC400503	x 10	R-PET	Vrac / Bulk	10/240
FEC400603	x 10	R-PET	Vrac / Bulk	10/240
FEC400703	x 10	R-PET	Vrac / Bulk	10/240
FEC400192	x 4	R-PET	LS / Pegboardable	12/72



De la bouteille au surligneur...

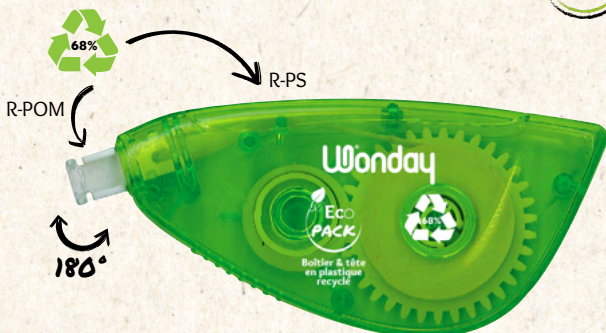
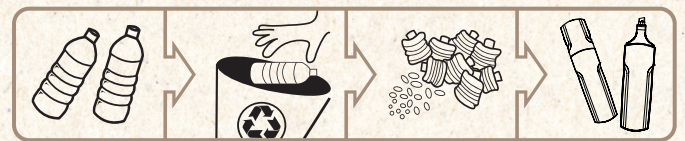

R-POM

R-PS

180°



RUBAN CORRECTEUR LATÉRAL DROITIER/GAUCHER
Sideway correction tape right/left

Largueur de 5 mm - Width 5 mm
Tête pivotante 180° droitier/gaucher - Right/left swivel head 180°

REF.	TAILLE/SIZE	CARACTÉRISTIQUES SPECIFICATIONS	CONDITIONNEMENT PACKING	LIV/PCB
FCR120002	5 mm x 12 m		Vrac / Bulk	24/144



TROUSSES RONDES

Rounded pencil cases

Tissu 68% R-PET - Made of 68% R-PET fabric
Fermeture zippée - With zipper



REF.	DIMENSIONS	CARACTÉRISTIQUES SPECIFICATIONS	CONDITIONNEMENT PACKING	LIV/PCB
FFT200221	Ø 7,5 x 22 cm	R-PET	Vrac / Bulk	12/144
FFT200321	Ø 7,5 x 22 cm	R-PET	Vrac / Bulk	12/144

GAMME GREEN

Eco-friendly products



GAMME TROMB'LINE INCASSABLE SHATTERPROOF TROMB'LINE RANGE

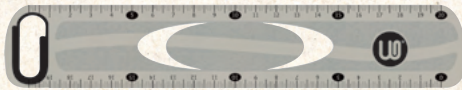

DOUBLE ET TRIPLE DÉCIMÈTRES INCASSABLES Shatterproof 20 and 30 cm rulers with handle

2 biseaux gradués en mm - 2 bevels scaled in mm
Corps plastique 80 % R-PET - 80 % R-PET plastic body

REF.	DIMENSIONS	CARACTÉRISTIQUES SPECIFICATIONS	CONDITIONNEMENT PACKING	LIV/PCB
FTS220362	20 cm		LS / Pegboardable	20/200
FTS330262	30 cm		LS / Pegboardable	20/200

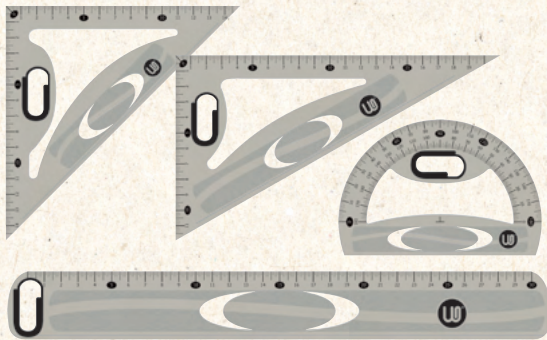

SET CARTON 4 PIÈCES INCASSABLE Shatterproof set 4 pieces

Double décimètre - 20 cm ruler with handle
Équerres 60° - 15 cm et 45° - 21 cm - Squares 60° - 15 cm and 45° - 21 cm
Rapporteur 180° - 12 cm - 180° - 12 cm protractor
Corps plastique 80 % R-PET - 80 % R-PET plastic body
Livré sous pochette carton - Delivered in cardboard pouch

REF.	DIMENSIONS	CARACTÉRISTIQUES SPECIFICATIONS	CONDITIONNEMENT PACKING	LIV/PCB
FTS040262			LS / Pegboardable	10/60

RAPPORTEUR INCASSABLE Shatterproof protractor

Double graduation en degrés - Double graduation in degrees
Corps plastique 80 % R-PET - 80 % R-PET plastic body

REF.	DIMENSIONS	CARACTÉRISTIQUES SPECIFICATIONS	CONDITIONNEMENT PACKING	LIV/PCB
FTS850262	180° - 12 cm		LS / Pegboardable	20/200



RÈGLES PLATES INCASSABLES Shatterproof flat rulers

1 biseau gradué en mm - 1 bevel scaled in mm
Corps plastique 80 % R-PET - 80 % R-PET plastic body
Bord antitache - Anti-stain edge

REF.	DIMENSIONS	CARACTÉRISTIQUES SPECIFICATIONS	CONDITIONNEMENT PACKING	LIV/PCB
FTS200262	20 cm		LS / Pegboardable	20/200
FTS300362	30 cm		LS / Pegboardable	20/200
FTS400262	40 cm		LS / Pegboardable	20/100

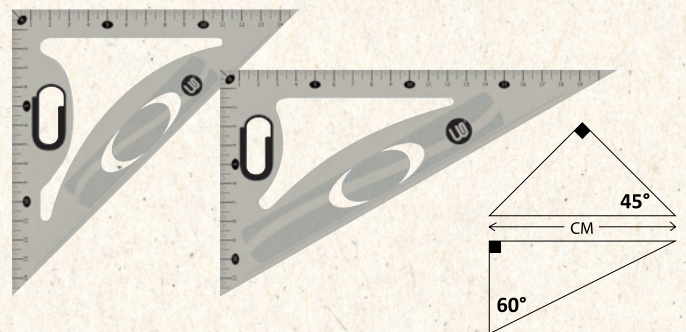

ÉQUERRES INCASSABLES Shatterproof squares

1 biseau gradué en mm - 1 bevel scaled in mm
Indication de l'angle droit - Shows right angle
Bord antitache - Anti-stain edge
Corps plastique 80 % R-PET - 80 % R-PET plastic body

REF.	DIMENSIONS	CARACTÉRISTIQUES SPECIFICATIONS	CONDITIONNEMENT PACKING	LIV/PCB
FTS750662	60° - 21 cm		LS / Pegboardable	20/200
FTS700462	45° - 21 cm		LS / Pegboardable	20/200



CLASSEURS SOUPLES

Flexible binders

Classeur fabriqué à partir de PP vierge à 50% et de fibre de blé à 50%

Binder made from 50% virgin PP and 50% wheat fiber

Dos 37 mm - 37 mm back

4 anneaux métal Ø 27 mm - 4 metal rings Ø 27 mm

Pour feuilles A4, intercalaires et pochettes - For A4 sheets, dividers and pockets

REF.	DIM. (HXL CM)	CARACTÉRISTIQUES SPECIFICATIONS	CONDITIONNEMENT PACKING	UV/PCB
FCM700101	31,5 x 52 (Ouvert/Open)	50% PP vierge-50% fibre de blé 50% virgin PP-50% wheat fiber	Vrac / Bulk	1/36
FCM700201	31,5 x 52 (Ouvert/Open)	50% PP vierge-50% fibre de blé 50% virgin PP-50% wheat fiber	Vrac / Bulk	1/36



Pochette en R-PP

POCHETTES POLYPRO SEMI-TRANSPARENTES

Semi-transparent PP filings

Épaisseur 0,2 mm - Thickness 0,2 mm

Fermeture à scratch - Velcro closure

Pour documents A4 - For A4 documents

REF.	DIM. (HXL CM)	CARACTÉRISTIQUES SPECIFICATIONS	CONDITIONNEMENT PACKING	UV/PCB
FCM202001	335 x 240	R-PP	Vrac / Bulk	10/240
FCM202101	335 x 240	R-PP	Vrac / Bulk	10/240



CHEMISES 3 RABATS

3 flaps folders

Fabriquées à partir de PP vierge à 65% et de fibre de blé à 35% - Made from 65% virgin PP and 35% wheat fiber

3 rabats - 3 flaps

Épaisseur 0,4 mm - Thickness 0,4 mm

Fermetures par élastiques - Elastic closure

Pour documents A4 - For A4 documents

REF.	DIM. (HXL CM)	CARACTÉRISTIQUES SPECIFICATIONS	CONDITIONNEMENT PACKING	UV/PCB
FCM400401	31,8 x 24	65% PP vierge-35% fibre de blé 65% virgin PP-35% wheat fiber	Vrac / Bulk	10/120
FCM400501	31,8 x 24	65% PP vierge-35% fibre de blé 65% virgin PP-35% wheat fiber	Vrac / Bulk	10/120



Pochette en R-PP

CHEMISES 3 RABATS

3 flaps folders

Fabriquées en R-PP Recyclés à 100% - Made from 100% recycled R-PP

3 rabats - 3 flaps

Épaisseur 0,4 mm - Thickness 0,4 mm

Fermetures par élastiques - Elastic closure

Pour documents A4 - For A4 documents

REF.	DIM. (HXL CM)	CARACTÉRISTIQUES SPECIFICATIONS	CONDITIONNEMENT PACKING	UV/PCB
FCM400601	31,8 x 24	R-PP	Vrac / Bulk	10/120
FCM400701	31,8 x 24	R-PP	Vrac / Bulk	10/120

GAMME GREEN

Eco-friendly products



Corps en R-PS



PORTE-MARQUEURS MAGNÉTIQUE Magnetic pen holder

Aimant fort - Strong magnet
3 compartiments - 3 compartments



REF.	DIM. (HXL CM)	CARACTÉRISTIQUES SPECIFICATIONS	CONDITIONNEMENT PACKING	LIV/PCB
FSC800112	13 x 10 x 3,5	R-PS  	LS / Pegboardable	12/72



Corps en R-ABS

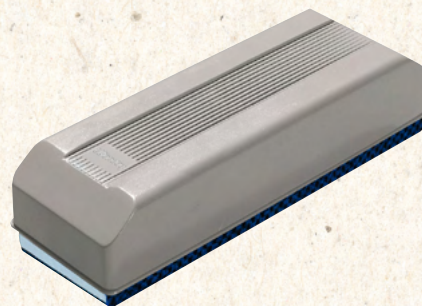

BROSSE POUR TABLEAUX BLANCS - MAGNÉTIQUE Whiteboards brush - Magnetic

Coque plastique R-ABS - R-ABS shell
Brosse velours ras - Short velvet brush
FSC700162 : 2 recharges magnétiques réversibles - 2 reversible magnetic refills

REF.	DIM. (HXLXPMM)	CARACTÉRISTIQUES SPECIFICATIONS	CONDITIONNEMENT PACKING	LIV/PCB
FSC650462	40 x 147 x 55	R-ABS  	LS / Pegboardable	12/96



Corps en R-ABS



PORTE-MARQUEURS MAGNÉTIQUE Magnetic pen holder

Pour 4 marqueurs (non inclus) - For 4 markers (not included)

REF.	DIM. (HXL CM)	CARACTÉRISTIQUES SPECIFICATIONS	CONDITIONNEMENT PACKING	LIV/PCB
FSC800013	13,5 x 10 x 4	R-ABS  	Vrac / Bulk	12/144



TURCIOIPS

Coque R-ABS - R-ABS shell
Brosse feutrine - Felt brush
Magnétique - Magnetic
Pour tableaux blancs - For whiteboards
Compartment pour 2 marqueurs - 2 markers storage
FSC700022 : 6 feutres rechargeables - 6 felts refill

REF.	DIM. (HXLXPMM)	CARACTÉRISTIQUES SPECIFICATIONS	CONDITIONNEMENT PACKING	LIV/PCB
FSC650162	175 x 47 x 65	R-ABS  	LS / Pegboardable	12/120



Corps en R-ABS



ADHÉSIF PAPIER KRAFT 50 MM X 50 M KRAFT adhesive tape 50 mm x 50 m

Mandrin en carton & kraft issus de forêts bien gérées certifiées - Cardboard mandrel & kraft from certified well-managed forests

REF.	DIM. (HXLMM)	ÉPAISSEUR THICKNESS	CARACTÉRISTIQUES SPECIFICATIONS	CONDITIONNEMENT PACKING	LIV/PCB
GAD800011	50 mm x 50 m	140 microns	KRAFT 	Vrac / Bulk	6/36

FOURNITURES

Office and school supplies

Tout, tout, tout... vous aurez tout pour le bureau ! Vous voilà prêts à couper, tailler, coller, agraffer, effacer, calculer, archiver, etc. Wonday se met en quatre pour faciliter tous vos gestes du quotidien. Pour les petits ou les plus grands, retrouvez les outils indispensables de tous les jours au bureau, à l'école ou à la maison. Pour bien « rouler » à l'école, il faut être bien équipé ! Des produits classiques consommables aux produits plus techniques, chez Wonday le choix est large.

Alors... roulez jeunesse !

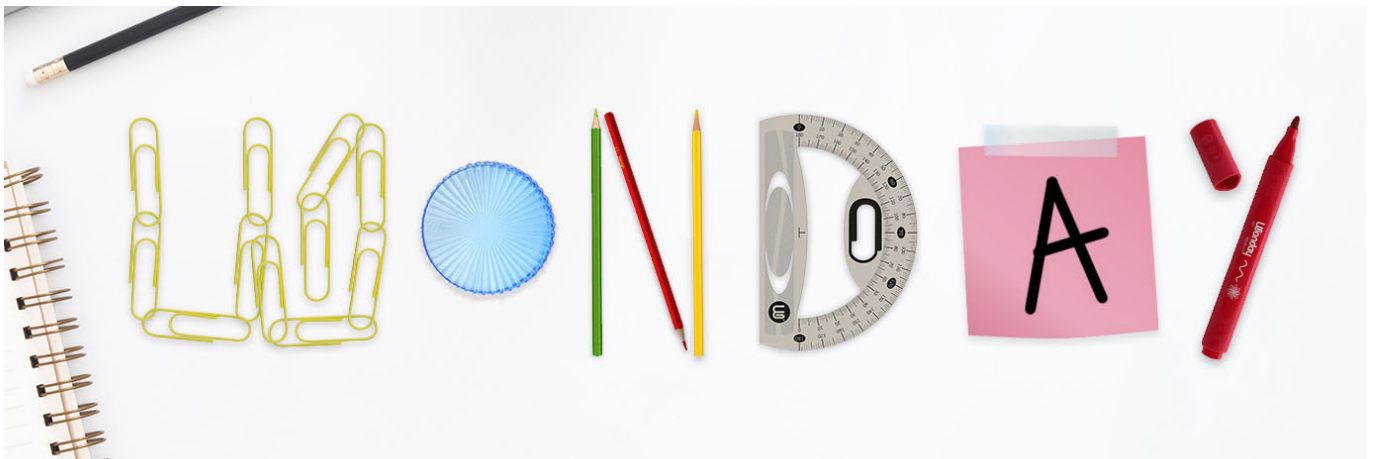

Wonday[®]

creative tools for school and business



CISEAUX BUREAU & MAISON / OFFICE & HOME SCISSORS







ERGO

Lames en acier inox trempé - Stainless steel blades

Double biseau - Double bevel blade

Anneaux asymétriques ergonomiques - Asymmetrical ergonomical handles

REF.	TAILLE SIZE	CARACTÉRISTIQUES SPECIFICATIONS	CONDITIONNEMENT PACKING	LIV/PCB
FCI250062	25 cm	PP  	LS / Pegboardable	12/96
FCI230462	23 cm	PP  	LS / Pegboardable	12/120









EVERBLUE

Lames en acier inox trempé - Stainless steel blades

Double biseau - Double bevel blade

Anneaux asymétriques (23 - 21 cm) / symétriques (17 cm) ergonomiques bi-matière (ABS-TPR) - Asymmetrical (23 - 21 cm) / symmetrical (17cm) ergonomical soft grip handles (ABS-TPR)

REF.	TAILLE SIZE	CARACTÉRISTIQUES SPECIFICATIONS	CONDITIONNEMENT PACKING	LIV/PCB
FCI230182	23 cm	ABS / TPR  	LS / Pegboardable	6/96
FCI210382	21 cm	ABS / TPR  	LS / Pegboardable	10/120
FCI170282	17 cm	ABS / TPR  	LS / Pegboardable	10/120

DÉCOUPER - TAILLER

Cut - Sharpen



NOUABLUE

Anneaux asymétriques ergonomiques en PP vierge à 75% et fibre de blé à 25% - 75% virgin PP and 25% wheat fiber ergonomic asymmetrical handles
Lames en acier inox trempé - Stainless steel blades
Double biseau - Double bevel blade
Couleur granulée - Granulated colour

REF.	TAILLE SIZE	CARACTÉRISTIQUES SPECIFICATIONS	CONDITIONNEMENT PACKING	UV/PCB
FCI213062	21 cm	PP Fibre de blé Wheat fiber	LS Pegboardable	12/120
FCI173062	17 cm	PP Fibre de blé Wheat fiber	LS Pegboardable	12/120
FCI133262	13 cm	PP Fibre de blé Wheat fiber	LS Pegboardable	12/240



NOUAGREEN

Lames en acier inox trempé - Stainless steel blades
Double biseau - Double bevel blade
Anneaux asymétriques ergonomiques en PP et fibre de blé
PP and wheat fiber asymmetrical ergonomic handles
Ciseaux démontables et recyclables - Recyclable removable scissors

REF.	TAILLE SIZE	CARACTÉRISTIQUES SPECIFICATIONS	CONDITIONNEMENT PACKING	UV/PCB
FCI211962	21 cm	PP Fibre de blé / Wheat fiber	LS Pegboardable	10/120
FCI172162	17 cm	PP Fibre de blé / Wheat fiber	LS Pegboardable	10/120

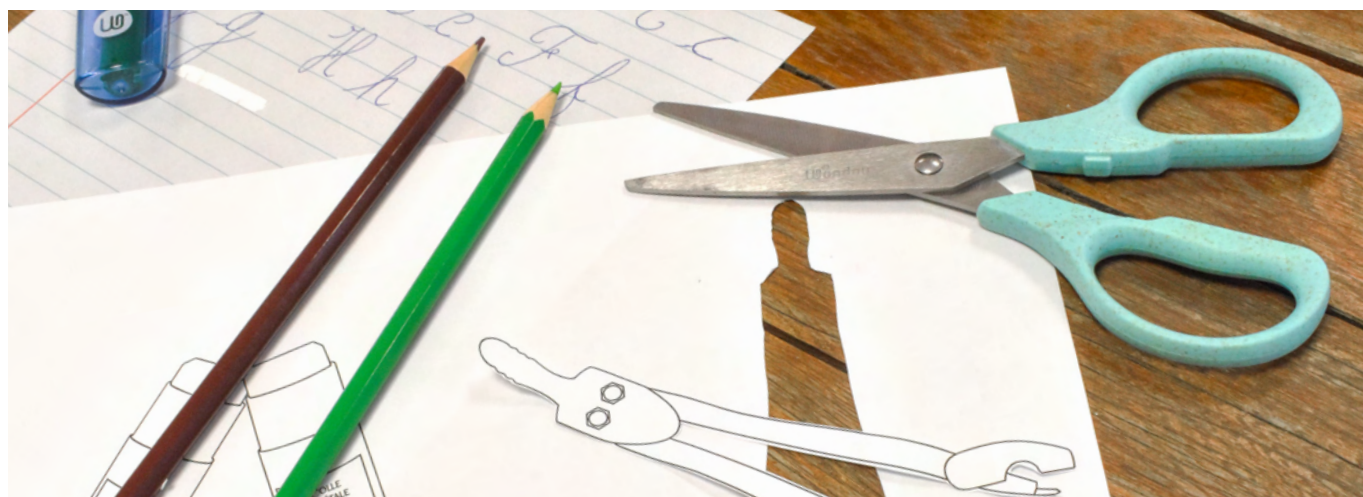



TWIN

Lames en acier inox trempé - *Stainless steel blades*
 Double biseau - *Double bevel blade*
 Anneaux asymétriques ergonomiques (ABS) - *Asymmetrical ergonomical handles (ABS)*

REF.	TAILLE SIZE	CARACTÉRISTIQUES SPECIFICATIONS	CONDITIONNEMENT PACKING	LIV/PCB
FCI211662*	21 cm	ABS	LS / Pegboardable	10/120
FCI171362*	17 cm	ABS	LS / Pegboardable	10/120

* Jusqu'à épauement des stocks



EVOLUT

Lames en acier inox trempé - *Stainless steel blades*
 Double biseau - *Double bevel blade*
 Anneaux asymétriques ergonomiques bi-matière (ABS-TPR) - *Asymmetrical ergonomical soft grip handles (ABS-TPR)*

REF.	TAILLE SIZE	CARACTÉRISTIQUES SPECIFICATIONS	CONDITIONNEMENT PACKING	LIV/PCB
FCI210482	21 cm	ABS / TPR	LS / Pegboardable	10/120
FCI170382	17 cm	ABS / TPR	LS / Pegboardable	10/120



COSY

Lames en acier inox trempé - *Stainless steel blades*
 Double biseau (21 cm) - *Double bevel blade (21 cm)*
 Anneaux asymétriques (21 cm) / symétriques (17 et 13 cm) bi-matière (PP-TPR) - *Asymmetrical (21 cm) / symmetrical (17 and 13 cm) soft grip handles (PP-TPR)*

REF.	TAILLE SIZE	CARACTÉRISTIQUES SPECIFICATIONS	CONDITIONNEMENT PACKING	LIV/PCB
FCI212882*	21 cm	PP / TPR	LS / Pegboardable	10/120
FCI132582*	13 cm	PP / TPR	LS / Pegboardable	10/300

* Jusqu'à épauement des stocks

SOLAR

Lames en acier inox trempé - *Stainless steel blades*
 Anneaux asymétriques ergonomiques (21 cm) - *Asymmetrical (21 cm) ergonomical handles*

REF.	TAILLE SIZE	CARACTÉRISTIQUES SPECIFICATIONS	CONDITIONNEMENT PACKING	LIV/PCB
FCI210862*	21 cm	ABS	LS / Pegboardable	12/120
FCI211861	21 cm	ABS	Vrac / Bulk	12/120

* Jusqu'à épauement des stocks



DÉCOUPER - TAILLER

Cut - Sharpen



CANDY

Lames en acier inox trempé - Stainless steel blades

Double biseau - Double bevel blade

Anneaux asymétriques (21 & 17) / symétriques (13 cm) bi-matière (PP-TPR)

Asymmetrical (21 & 17 cm) / symmetrical (13 cm) soft grip handles (PP-TPR)

REF.	TAILLE SIZE	CARACTÉRISTIQUES SPECIFICATIONS	CONDITIONNEMENT PACKING	LIV/PCB
FCI212782	21 cm	PP / TPR	LS / Pegboardable	10/120
FCI212682	21 cm	PP / TPR	LS / Pegboardable	10/120
FCI172382	17 cm	PP / TPR	LS / Pegboardable	10/120
FCI172482	17 cm	PP / TPR	LS / Pegboardable	10/120
FCI132482	13 cm	PP / TPR	LS / Pegboardable	10/300

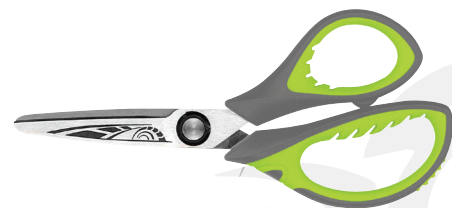

TRIBAL

Lames en acier inox trempé - Stainless steel blades

Anneaux asymétriques (21 et 13 cm) / symétriques (16 cm) bi matière (PP - TPR)

Asymmetrical (21 and 13 cm) / symmetrical (16cm) soft grip handles (PP-TPR)

REF.	TAILLE SIZE	CARACTÉRISTIQUES SPECIFICATIONS	CONDITIONNEMENT PACKING	LIV/PCB
FCI210282	21 cm	PP / TPR	LS / Pegboardable	12/120
FCI160082	16 cm	PP / TPR	LS / Pegboardable	12/120
FCI130282*	13 cm	PP / TPR	LS / Pegboardable	20/120
FCI130281	13 cm	PP / TPR	Vrac / Bulk	20/120

* Jusqu'à épuisement des stocks





PREMIUM

Lames en acier inox trempé incurvées à 30° pour une découpe plus fluide
 Curved blades 30° hardened stainless steel blades for easier cut

Double biseau - Double bevel blade

Grands anneaux symétriques bi-matière (PP-TPR) - Large symmetrical soft grip handles (PP-TPR)

REF.	TAILLE SIZE	CARACTÉRISTIQUES SPECIFICATIONS	CONDITIONNEMENT PACKING	LIV/PCB
FCI212982*	21 cm	PP / TPR 	LS / Pegboardable	12/120
FCI190382*	18.5 cm	PP / TPR 	LS / Pegboardable	12 /120

* Jusqu'à épuisement des stocks



**Lames incurvées 30°
= découpe plus fluide**
 Curved blades 30°
= Easier cut

Vis souple
 Flexible screw

**Grands anneaux bi-matière
pour plus de confort**
 Large bi-material handles
for better comfort



ÇA VOUS LA COUPE ?

FIRST

Lames en acier inox trempé - Stainless steel blades for easier cut

Double biseau - Double bevel blade

Anneaux asymétriques ergonomiques - Asymmetrical ergonomic handles

REF.	TAILLE SIZE	CARACTÉRISTIQUES SPECIFICATIONS	CONDITIONNEMENT PACKING	LIV/PCB
FCI210961	21 cm	PP 	Vrac / Bulk	12/120
FCI170761	17 cm	PP 	Vrac / Bulk	12/120



DÉCOUPER - TAILLER

Cut - Sharpen



INITIAL









Lames en acier inox trempé - *Stainless steel blades*
 Double biseau - *Double bevel blade*
 Anneaux asymétriques bi-matière (PP - TPR) - *Asymmetrical soft grip handles (PP-TPR)*
 Support index - *Forefinger place*
 Présentoir livré en boîte de 20 pcs (10 roses + 10 bleus) - *Display delivered in boxes of 20 pcs (10 pink + 10 blue)*

REF.	TAILLE SIZE	CARACTÉRISTIQUES SPECIFICATIONS	CONDITIONNEMENT PACKING	LIV/PCB
FCI130081	20 pcs	13 cm rose x 10 13 cm bleu x 10	Vrac / Bulk	20/320



INITIAL

Lames en acier inox trempé - *Stainless steel blades*
 Double biseau - *Double bevel blade*
 Anneaux asymétriques (21 et 17 cm) / symétriques (19 et 15 cm)
 bi-matière (PP - TPR) - *Asymmetrical (21 and 17) / symmetrical (19 et 15 cm)*
 soft grip handles (PP-TPR)
 Support index - *Forefinger place*
 000042 : présentoir livré en boîte de 24 pcs (6 x 21 cm + 6 x 19 cm + 6 x 17 cm + 6 x 15 cm) - *Display delivered in boxes of 24 pcs (6 x 21 cm + 6 x 19 cm + 6 x 17 cm + 6 x 15 cm)*

REF.	TAILLE SIZE	CARACTÉRISTIQUES SPECIFICATIONS	CONDITIONNEMENT PACKING	LIV/PCB
FCI210182	21 cm	PP / TPR	 	LS / Pegboardable 12/120
FCI190182	19 cm	PP / TPR	 	LS / Pegboardable 12/120
FCI170182	17 cm	PP / TPR	 	LS / Pegboardable 12/120
FCI150182	15 cm	PP / TPR	 	LS / Pegboardable 12/120
000042*	24 pcs	21 cm x 6 19 cm x 6 17 cm x 6 15 cm x 6	Présentoir / Display	1/1





* Jusqu'à épuisement des stocks





AMBI'NOX BOUTS RONDS





Lames en acier inox trempé - *Stainless steel blades*
 Double biseau - *Double bevel blade*
 Anneaux symétriques bi-matière (inox - TPR) - *Symmetrical soft grip handle (inox - TPR)*

REF.	TAILLE SIZE	CARACTÉRISTIQUES SPECIFICATIONS	CONDITIONNEMENT PACKING	LIV/PCB
FCI200071	20 cm	Acier inox / TPR Inox steel  	Vrac / Bulk	12/144
FCI171571	17 cm	Acier inox / TPR Inox steel  	Vrac / Bulk	12/144



AMBI'NOX BOUTS POINTUS

Lames en acier inox trempé - *Stainless steel blades*
 Double biseau - *Double bevel blade*
 Anneaux symétriques bi-matière (inox - TPR) - *Symmetrical soft grip handle (inox - TPR)*

REF.	TAILLE SIZE	CARACTÉRISTIQUES SPECIFICATIONS	CONDITIONNEMENT PACKING	LIV/PCB
FCI200171	20 cm	Acier inox / TPR Inox steel  	Vrac / Bulk	12/144
FCI171671	17 cm	Acier inox / TPR Inox steel  	Vrac / Bulk	12/144



AMBI'NOX NON-STICK

Lames en acier inox trempé avec un revêtement antiadhérent - *Stainless steel blades with non-stick coating*
 Double biseau - *Double bevel blade*
 Anneaux symétriques bi-matière (inox - TPR) - *Symmetrical soft grip handle (inox - TPR)*

REF.	TAILLE SIZE	CARACTÉRISTIQUES SPECIFICATIONS	CONDITIONNEMENT PACKING	LIV/PCB
FCI172772*	17 cm	Acier inox / TPR Inox steel  	LS / Pegboardable	12/144

* Jusqu'à épuisement des stocks

DÉCOUPER - TAILLER

Cut - Sharpen



ELECTRON

Lames en acier inox trempé - *Stainless steel blades*
 Anneaux asymétriques décentrés par rapport aux lames pour une découpe bien à plat - *Asymmetric off-center handles for a flat cut*

REF.	TAILLE SIZE	CARACTÉRISTIQUES SPECIFICATIONS	CONDITIONNEMENT PACKING	LIV/PCB
FCI211362*	21 cm	PP	LS / Pegboardable	12/120
FCI211261	21 cm	PP	Vrac / Bulk	12/120

* Jusqu'à épuisement des stocks



Lames en acier inox trempé - *Stainless steel blades*
 Grands anneaux symétriques - *Large symmetrical handles*

REF.	TAILLE SIZE	CARACTÉRISTIQUES SPECIFICATIONS	CONDITIONNEMENT PACKING	LIV/PCB
FCI211162	21 cm	PP	LS / Pegboardable	12/120
FCI211061	21 cm	PP	Vrac / Bulk	12/120
FCI171162	17 cm	PP	LS / Pegboardable	12/120
FCI171061	17 cm	PP	Vrac / Bulk	12/120
FCI170962	17 cm	PP	LS / Pegboardable	12/120
FCI170861	17 cm	PP	Vrac / Bulk	12/120



ELECTRON GAUCHER

Lames en acier inox trempé spécialement inversées pour couper à gauche - *Stainless steel left-handed reversed blades*
 Anneaux asymétriques décentrés par rapport aux lames pour une découpe bien à plat - *Asymmetric off-center handles for a flat cut*

REF.	TAILLE SIZE	CARACTÉRISTIQUES SPECIFICATIONS	CONDITIONNEMENT PACKING	LIV/PCB
FCI211452	21 cm	PP	LS / Pegboardable	12/120

Lames en acier inox trempé spécialement inversées pour couper à gauche - *Stainless steel left-handed reversed blades*
 Grands anneaux symétriques - *Large symmetrical handles*

REF.	TAILLE SIZE	CARACTÉRISTIQUES SPECIFICATIONS	CONDITIONNEMENT PACKING	LIV/PCB
FCI171252	17 cm	PP	LS / Pegboardable	12/120





ROBUST

Lames en acier inox trempé microdentées - *Stainless steel micro serrated blades*
Grands anneaux symétriques - *Large symmetrical handles*
Multifonctions - *Multifunctions*

REF.	TAILLE SIZE	CARACTÉRISTIQUES SPECIFICATIONS	CONDITIONNEMENT PACKING	LIV/PCB
FCI170662	17 cm	PP  	LS / Pegboardable	10/120



LITHOGRAPHE

Lames de précision en acier inox trempé brillant - *Shiny stainless steel accuracy blades*
Anneaux symétriques - *Symmetrical handles*
Pointes très effilées - *Very sharp blades*

REF.	TAILLE SIZE	CARACTÉRISTIQUES SPECIFICATIONS	CONDITIONNEMENT PACKING	LIV/PCB
FCI171772	17 cm	Acier inox Inox steel  	LS / Pegboardable	12/120



STANDECO

Lames en acier inox trempé - *Stainless steel blades*
Anneaux symétriques - *Symmetrical handles*

REF.	TAILLE SIZE	CARACTÉRISTIQUES SPECIFICATIONS	CONDITIONNEMENT PACKING	LIV/PCB
FCI160161	16 cm	PP  	Vrac / Bulk	12/240



PRÉCISION

Lames de précision en acier inox trempé brillant - *Precision shiny tempered stainless steel blades*
Anneaux symétriques - *Symmetrical handles*
Pointes effilées - *Sharp blades*

REF.	TAILLE SIZE	CARACTÉRISTIQUES SPECIFICATIONS	CONDITIONNEMENT PACKING	LIV/PCB
FCI110172*	12 cm	Acier inox Inox steel  	LS / Pegboardable	12/120

* Jusqu'à épauement des stocks



FIVE'CUT

5 lames en acier inox trempé idéal pour activités manuelles - *5 stainless steel blades ideal for manual activities*
Grands anneaux symétriques - *Large symmetrical handles*

REF.	TAILLE SIZE	CARACTÉRISTIQUES SPECIFICATIONS	CONDITIONNEMENT PACKING	LIV/PCB
FCI190481*	19 cm	PP  	Vrac / Bulk	12/72

* Jusqu'à épauement des stocks



DÉCOUPER - TAILLER

Cut - Sharpen

CISEAUX ÉCOLE / SCHOOL SCISSORS



SECURITY

Ciseaux sécurité - Safety scissors
Lames et anneaux en ABS - ABS blades and handles
Anneaux symétriques - Symmetrical handles
Ne coupent ni les cheveux, ni les vêtements, ni la peau
Do not cut hair, skin or clothes

REF.	TAILLE SIZE	CARACTÉRISTIQUES SPECIFICATIONS	CONDITIONNEMENT PACKING	LIV/PCB
FCI120462	12.5 cm	ABS  	LS / Pegboardable	10/300



DÉCOUPER EN TOUTE SÉCURITÉ !



PTI'FUTÉ

Lames en acier inox trempé - Stainless steel blades
Anneaux asymétriques - Asymmetrical handles
Système ressort des anneaux - Rings with spring lever system

REF.	TAILLE SIZE	CARACTÉRISTIQUES SPECIFICATIONS	CONDITIONNEMENT PACKING	LIV/PCB
FCI131061	13 cm	PP   	Vrac / Bulk	12/480



PEDAGO

Apprentissage de la découpe - Cutting practice
Lames en acier inox trempé graduées - Graduated stainless steel blades
4 anneaux symétriques - 4 symmetrical handles

REF.	TAILLE SIZE	CARACTÉRISTIQUES SPECIFICATIONS	CONDITIONNEMENT PACKING	LIV/PCB
FCI131161	13 cm	PP  	Vrac / Bulk	12/300



DÉCOUPER - TAILLER

Cut - Sharpener



TOP

Lames en acier inox trempé - *Stainless steel blades*
Anneaux symétriques ronds - *Round symmetrical handles*

REF.	TAILLE SIZE	CARACTÉRISTIQUES SPECIFICATIONS	CONDITIONNEMENT PACKING	LIV/PCB
FCI130781	13 cm	PP	Vrac / Bulk	24/480



SCHOLA

Lames en acier inox trempé - *Stainless steel blades*
Anneaux asymétriques ergonomiques - *Asymmetrical ergonomical handles*

REF.	TAILLE SIZE	CARACTÉRISTIQUES SPECIFICATIONS	CONDITIONNEMENT PACKING	LIV/PCB
FCI132161	13 cm	PP	Vrac / Bulk	10/300

SCHOLA GAUCHER

Lames en acier inox trempé spécialement inversées pour couper à gauche
Stainless steel left-handed reversed blades
Anneaux asymétriques ergonomiques - *Asymmetrical ergonomical handles*

REF.	TAILLE SIZE	CARACTÉRISTIQUES SPECIFICATIONS	CONDITIONNEMENT PACKING	LIV/PCB
FCI132251	13 cm	PP	Vrac / Bulk	12/480



JUNIOR

Lames en acier inox trempé - *Stainless steel blades*
Anneaux asymétriques bi-matière (PP - TPR) - *Asymmetrical soft grip handles (PP-TPR)*

REF.	TAILLE SIZE	CARACTÉRISTIQUES SPECIFICATIONS	CONDITIONNEMENT PACKING	LIV/PCB
FCI130881	13 cm	PP / TPR	Vrac / Bulk	24/360

UNI'VERT

Lames en acier inox trempé - *Stainless steel blades*
Anneaux asymétriques bi-matière (RPP - RTPR) - *Asymmetrical soft grip handles (RPP-RTPR)*

REF.	TAILLE SIZE	CARACTÉRISTIQUES SPECIFICATIONS	CONDITIONNEMENT PACKING	LIV/PCB
FCI130481	13 cm	RPP / RTPR	Vrac / Bulk	24/360





DÉCOUPER - TAILLER

Cut - Sharpen



CAÏD

Lames en acier inox trempé - *Stainless steel blades*
 Anneaux asymétriques bi-matière (PP - TPR) - *Asymmetrical soft grip handles (PP-TPR)*
 Support index - *Forefinger place*
 FCI150281 et FCI130181 : présentoir livré en boîte de 20 pcs (10 prune + 10 vert) - *Display delivered in boxes of 20 pcs (10 plum + 10 green)*

REF.	TAILLE / SIZE	CARACTÉRISTIQUES / SPECIFICATIONS	CONDITIONNEMENT / PACKING	LIV/PCB
FCI150382*	15 cm	PP / TPR  	LS / Pegboardable	25/100
FCI150281*	20 pcs	PP / TPR 15 cm prune x 10 / 15 cm vert x 10	Vrac / Bulk	20/320
FCI130182*	13 cm	PP / TPR  	LS / Pegboardable	25/100
FCI130181*	20 pcs	PP / TPR 13 cm prune x 10 / 13 cm vert x 10	Vrac / Bulk	20/320

* Jusqu'à épuisement des stocks



CADOU

Lames en acier inox trempé - *Stainless steel blades*
 Anneaux asymétriques bi-matière - *Asymmetrical soft grip handles*







REF.	TAILLE / SIZE	CARACTÉRISTIQUES / SPECIFICATIONS	CONDITIONNEMENT / PACKING	LIV/PCB
FCI132381	13 cm	PP / TPR  	Vrac / Bulk	24/480



CAÏD GAUCHER

Lames en acier inox trempé spécialement inversées pour couper à gauche - *Stainless steel left-handed reversed blades*
 Anneaux asymétriques bi-matière (PP - TPR) - *Asymmetrical soft grip handles (PP-TPR)*
 026922 : présentoir livré en boîte de 20 pcs (10 x 13 cm + 10 x 15 cm)
 Display delivered in boxes of 20 pcs (10 x 13 cm + 10 x 15 cm)

REF.	TAILLE / SIZE	CARACTÉRISTIQUES / SPECIFICATIONS	CONDITIONNEMENT / PACKING	LIV/PCB
FCI150452	15 cm	PP / TPR  	LS / Pegboardable	12/240
FCI130352	13 cm	PP / TPR  	LS / Pegboardable	12/240



NOUVEAUX COLORIS DÉBUT 2025
NEW COLORS EARLY 2025

CAÏD

















REF.	TAILLE / SIZE	CARACTÉRISTIQUES / SPECIFICATIONS	CONDITIONNEMENT / PACKING	LIV/PCB
FCI130181	13 cm x 20 pcs	PP / TPR  	Vrac / Bulk	20/320



ENZO

Lames en acier inox trempé graduées - Graduated hardened stainless steel blades

Anneaux symétriques avec support index - Symmetrical handles with forefinger place

REF.	TAILLE SIZE	CARACTÉRISTIQUES SPECIFICATIONS	CONDITIONNEMENT PACKING	UV/PCB
FCI150662	15 cm	PP    	LS / Pegboardable	25/300
FCI150561	15 cm	PP    	Vrac / Bulk	20/480
FCI120162	12 cm	PP    	LS / Pegboardable	25/300
FCI120061	12 cm	PP    	Vrac / Bulk	20/480

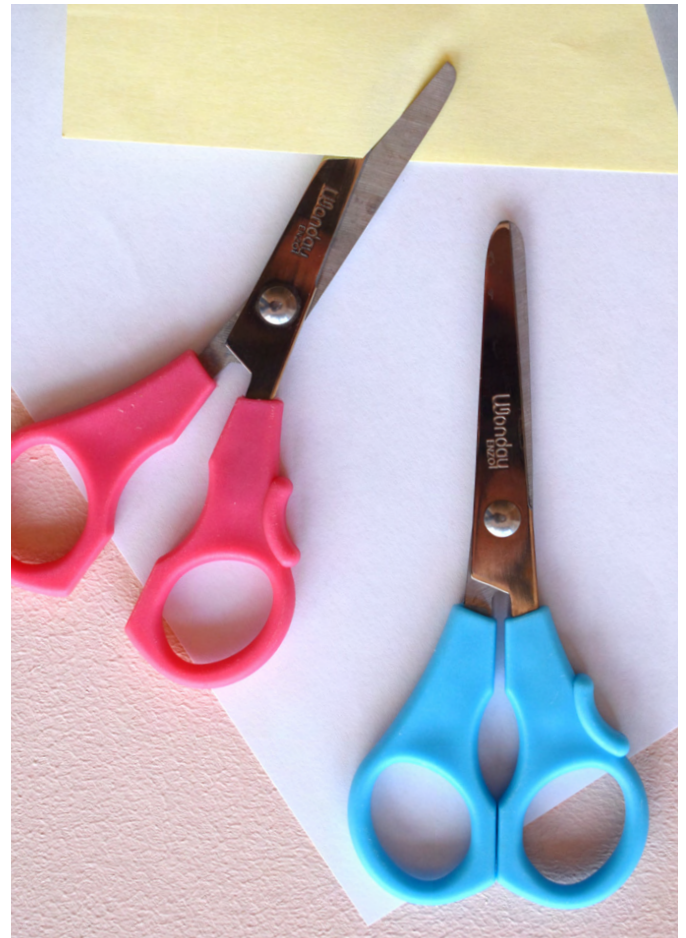







ENZO GAUCHER



Lames en acier inox trempé spécialement inversées pour couper à gauche
Stainless steel left-handed reversed blades

Anneaux symétriques avec support index - Symmetrical handles with forefinger place

REF.	TAILLE SIZE	CARACTÉRISTIQUES SPECIFICATIONS	CONDITIONNEMENT PACKING	UV/PCB
FCI120352	12 cm	PP   	LS / Pegboardable	12/240
FCI120251	12 cm	PP   	Vrac / Bulk	20/480

CLASSPACK ENZO

Range-ciseaux en plastique ABS - ABS plastic classpack

25 emplacements - 25 compartments

25 pcs : 20 x 12 cm droitier vert/bleu/rose, 5 x 12 cm gaucher

25 pcs : 20 x 12 cm green/blue/pink, 5 x 12 cm left

REF.	TAILLE/SIZE	CARACTÉRISTIQUES SPECIFICATIONS	CONDITIONNEMENT PACKING	UV/PCB
FCI900063	25 pcs	12 cm vert/bleu/rose x 20 12 cm rouge gaucher x 5	Présentoir / Display	1/16
FDB100061	128x128x77 mm Vide/Empty	PP 	Vrac / Bulk	1/24











DÉCOUPER - TAILLER

Cut - Sharpen



SWING

Lames en acier inox trempé - Stainless steel blades
Anneaux symétriques - Symmetrical handles

REF.	TAILLE SIZE	CARACTÉRISTIQUES SPECIFICATIONS	CONDITIONNEMENT PACKING	LIV/PCB
FCI150761	15 cm	PP  	Vrac / Bulk	12/300
FCI131362*	13 cm	PP   	LS / Pegboardable	10/300
FCI130961	13 cm	PP   	Vrac / Bulk	12/480

*Jusqu'à épuisement des stocks



SWING GAUCHER

Lames en acier inox trempé spécialement inversées pour couper à gauche - Stainless steel left-handed reversed blades
Anneaux symétriques - Symmetrical handles

REF.	TAILLE SIZE	CARACTÉRISTIQUES SPECIFICATIONS	CONDITIONNEMENT PACKING	LIV/PCB
FCI131451	13 cm	PP   	Vrac / Bulk	12/480







ADO

Lames de précision en acier inox trempé - Precision shiny tempered stainless steel blades
Anneaux symétriques - Symmetrical handles

REF.	TAILLE SIZE	CARACTÉRISTIQUES SPECIFICATIONS	CONDITIONNEMENT PACKING	LIV/PCB
FCI131261	13 cm	PP  	Vrac / Bulk	12/480

MAX ET MAXOU

Premiers ciseaux d'écolier - First school scissors
Lames en acier inox trempé - Stainless steel blades
Anneaux symétriques - Symmetrical handles

REF.	TAILLE SIZE	CARACTÉRISTIQUES SPECIFICATIONS	CONDITIONNEMENT PACKING	LIV/PCB
FCI110061	11 cm	PP  	Vrac / Bulk	12/480
FCI100061	10 cm	PP  	Vrac / Bulk	12/480



MINI BABY

Pour les petites mains - For small hands
Lames en acier inox trempé - Stainless steel blades
Anneaux symétriques - Symmetrical handles

REF.	TAILLE SIZE	CARACTÉRISTIQUES SPECIFICATIONS	CONDITIONNEMENT PACKING	LIV/PCB
FCI100161	10 cm	PP  	Vrac / Bulk	20/480

TAILLE-CRAYONS / PENCIL SHARPENERS



TAILLE-CRAYONS ÉLECTRIQUE 2 USAGES

2-holes electric sharpener

Pour des crayons de Ø 6 à Ø 12 mm - For Ø 6 to Ø 12 mm pencils
Le trou « gros module » est protégé par un clapet - « Large hole » is protected by a flap

Fonctionne sur secteur (adaptateur fourni) ou avec 4 piles LR6 (non fournies)
Works on mains supply (adaptor included) or 4 LR6 batteries (not included)

REF.	TAILLE SIZE	CARACTÉRISTIQUES SPECIFICATIONS	CONDITIONNEMENT PACKING	LIV/PCB
FTC150163	Ø 6/12 mm		Boîte / Box	1/48
FTC900361	-	Acier / Steel	LS / Pegboardable	1/100



TAILLE-CRAYONS ÉLECTRIQUE 1 USAGE

1-hole electric sharpener

Pour des crayons de Ø 6 à Ø 8 mm - For Ø 6 to Ø 8 mm pencils
Fonctionne automatiquement lorsque vous insérez le crayon
Starts automatically when the pencil is inserted

Fonctionne avec 4 piles LR6 (non fournies) - 4 LR6 batteries operated (not included)

+ 1 lame de rechange sous le taille-crayons - + 1 spare blade below sharpener

REF.	TAILLE SIZE	CARACTÉRISTIQUES SPECIFICATIONS	CONDITIONNEMENT PACKING	LIV/PCB
FTC150063	Ø 6/8 mm		Boîte / Box	1/72



MACHINE À TAILLER

Desktop pencil sharpener

Pour des crayons de Ø 8 à Ø 12 mm - For Ø 8 to Ø 12 mm pencils
Avec réserve à copeaux - With chip container box

Fraise en acier - Steel mill

Étrier de fixation - Fixing stirrup

REF.	TAILLE SIZE	CARACTÉRISTIQUES SPECIFICATIONS	CONDITIONNEMENT PACKING	LIV/PCB
FTC510071	Ø 8/12 mm	PS - ABS	Boîte / Box	1/48
FTC900271	-	Acier / Iron	Vrac / Bulk	1/240



MACHINE À TAILLER STANDARD

Standard desktop pencil sharpener

Pour des crayons de Ø 4 à Ø 8 mm - For Ø 4 to Ø 8 mm pencils
Avec réserve à copeaux - With chip container box

Fraise en acier - Steel mill

Étrier de fixation - Fixing stirrup

REF.	TAILLE SIZE	CARACTÉRISTIQUES SPECIFICATIONS	CONDITIONNEMENT PACKING	LIV/PCB
FTC500071	Ø 4/8 mm	PS - ABS	Boîte / Box	1/30
FTC900071	-	Acier / Iron	Vrac / Bulk	1/200

DÉCOUPER - TAILLER

Cut - Sharpen



TAILL'LIBERTY MÉTAL

Taille-crayons 2 usages - 2-Holes pencil sharpener
 Pour des crayons de Ø 6 à Ø 12 mm - For Ø 6 to Ø 12 mm pencils
 Réserve vissée - Screwed-on bin
 Corps plastique - Plastic body
 Taille-crayons métal - Metal sharpener

REF.	TAILLE SIZE	CARACTÉRISTIQUES SPECIFICATIONS	CONDITIONNEMENT PACKING	UV/PCB
FTC250571	Ø 6/12 mm	PS-ABS-Métal PS-ABS-Metal	Vrac / Bulk	12/120
FTC250371	Ø 6/12 mm	PS-ABS-Métal PS-ABS-Metal	Vrac / Bulk	12/120



TAILLE-CRAYONS MÉTAL

Taille-crayons 2 usages - 2-Holes pencil sharpener
 Pour des crayons de Ø 6 à Ø 12 mm - For Ø 6 to Ø 12 mm pencils
 Réserve clipsée - Clip-on bin
 Corps plastique - Plastic body
 Taille-crayons métal - Metal sharpener

REF.	TAILLE SIZE	CARACTÉRISTIQUES SPECIFICATIONS	CONDITIONNEMENT PACKING	UV/PCB
FTC251071	Ø 6/12 mm	PS-PE-Métal PS-PE-Metal	Vrac / Bulk	12/480



TAILL'LIBERTY PLASTIQUE

Taille-crayons 2 usages - 2-Holes pencil sharpener
 Pour des crayons de Ø 6 à Ø 12 mm - For Ø 6 to Ø 12 mm pencils
 Réserve vissée - Screwed-on bin
 Corps plastique - Plastic body
 Taille-crayons plastique - Plastic sharpener

REF.	TAILLE SIZE	CARACTÉRISTIQUES SPECIFICATIONS	CONDITIONNEMENT PACKING	UV/PCB
FTC250461	Ø 6/12 mm	PS-ABS	Vrac / Bulk	12/120



TAILLE-CRAYONS PLASTIQUE

Plastic pencil sharpener

Taille-crayons 2 usages - 2-Holes pencil sharpener
 Pour des crayons de Ø 6 à Ø 12 mm - For Ø 6 to Ø 12 mm pencils
 Réserve clipsée - Clip-on bin
 Corps plastique - Plastic body
 Taille-crayons plastique - Plastic sharpener

REF.	TAILLE SIZE	CARACTÉRISTIQUES SPECIFICATIONS	CONDITIONNEMENT PACKING	UV/PCB
FTC250961	Ø 6/12 mm	PS-PE	Vrac / Bulk	12/480
FTC251601*	Ø 6/12 mm	PS-PE	Vrac / Bulk	12/480

* Jusqu'à épuisement des stocks

TOO'DOU

Taille-crayons 2 usages - 2-Holes pencil sharpener
 Pour des crayons de Ø 6 à Ø 12 mm - For Ø 6 to Ø 12 mm pencils
 Réserve avec protection anti-déversement - Bin with spill protection
 Corps plastique, toucher doux - Plastic body, soft touch
 Taille-crayons plastique - Plastic sharpener

REF.	TAILLE SIZE	CARACTÉRISTIQUES SPECIFICATIONS	CONDITIONNEMENT PACKING	UV/PCB
FTC250863*	Ø 6/12 mm	PS-ABS	Vrac / Bulk	12/144

* Jusqu'à épuisement des stocks



**IDÉAL POUR
LES TRÈS
GROS
CRAYONS**

TAILL'TOU

Taille-crayons 3 usages - 3-Holes pencil sharpener
Pour des crayons de Ø 6 à Ø 17 mm - For Ø 6 to Ø 17 mm pencils
Système d'ouverture et de fermeture - Opening and closing system
Corps plastique - Plastic body
Taille-crayons plastique - Plastic sharpener
Livré en boîte de 20 pces - Delivered in boxes of 20 pcs

REF.	TAILLE SIZE	CARACTÉRISTIQUES SPECIFICATIONS	CONDITIONNEMENT PACKING	LIV/PCB
FTC350063	Ø 6/17 mm	PS-ABS	Vrac / Bulk	20/400



SHIELD

Taille-crayons 2 usages - 2-Holes pencil sharpener
Pour des crayons de Ø 8 à Ø 11 mm - For Ø 8 to Ø 11 mm pencils
Réserve clipsée - Clip-on bin
Corps plastique bi-matière + clapet de fermeture - Bi-material plastic body + closing flap
Taille-crayons plastique - Plastic sharpener

REF.	TAILLE SIZE	CARACTÉRISTIQUES SPECIFICATIONS	CONDITIONNEMENT PACKING	LIV/ PCB
FTC251281	Ø 8/11 mm	PP-TPR	Vrac / Bulk	24/576



ÉCO

Taille-crayons 2 usages - 2-Holes pencil sharpener
Pour des crayons de Ø 6 à Ø 12 mm - For Ø 6 to Ø 12 mm pencils
Réserve vissée - Screwed-on bin
Corps plastique - Plastic body
Taille-crayons plastique - Plastic sharpener

REF.	TAILLE SIZE	CARACTÉRISTIQUES SPECIFICATIONS	CONDITIONNEMENT PACKING	LIV/PCB
FTC250762	Ø 6/12 mm	PS-ABS	LS / pegbordable	24/240

DÉCOUPER - TAILLER

Cut - Sharpen



TAILLE-CRAYONS RECYCLÉ

Taille-crayons 1 usage - 1-Hole pencil sharpener
 Pour des crayons de Ø 6 à Ø 12 mm - For Ø 6 to Ø 12 mm pencils
 Réserve clipsée - Clip-on bin
 Corps plastique recyclé - Recycled plastic body
 Taille-crayons plastique - Plastic sharpener
 Livré en boîte de 24 pcs - Delivered in box of 24 pcs

REF.	TAILLE SIZE	CARACTÉRISTIQUES SPECIFICATIONS	CONDITIONNEMENT PACKING	UV/PCB
FTC150483	Ø 6/12 mm	R-PS R-ABS	Vrac / Bulk	24/144



BOBSY

Taille-crayons 2 usages - 2-Holes pencil sharpener
 Pour des crayons de Ø 6 à Ø 12 mm - For Ø 6 to Ø 12 mm pencils
 Réserve clipsée - Clip-on bin
 Corps plastique - Plastic body
 Taille-crayons plastique - Plastic sharpener
 Livré en boîte de 24 pcs - Delivered in box of 24 pcs

REF.	TAILLE SIZE	CARACTÉRISTIQUES SPECIFICATIONS	CONDITIONNEMENT PACKING	UV/PCB
FTC250063	Ø 6/12 mm	PS-ABS	Vrac / Bulk	24/144



TANDEMO

Taille-crayons 2 usages - 2-Holes pencil sharpener
 Pour des crayons de Ø 6 à Ø 12 mm - For Ø 6 to Ø 12 mm pencils
 Réserve clipsée - Clip-on bin
 Corps plastique - Plastic body
 Taille-crayons plastique - Plastic sharpener
 Livré en boîte de 20 pcs - Delivered in box of 20 pcs

REF.	TAILLE SIZE	CARACTÉRISTIQUES SPECIFICATIONS	CONDITIONNEMENT PACKING	UV/PCB
FTC250263	Ø 6/12 mm	PS-ABS	Vrac / Bulk	20/240



TOM

Taille-crayons 2 usages - 2-Holes pencil sharpener
 Pour des crayons de Ø 6 à Ø 12 mm - For Ø 6 to Ø 12 mm pencils
 Réserve clipsée - Clip-on bin
 Corps plastique - Plastic body
 Taille-crayons plastique - Plastic sharpener
 Livré en boîte de 24 pcs - Delivered in box of 24 pcs

REF.	TAILLE SIZE	CARACTÉRISTIQUES SPECIFICATIONS	CONDITIONNEMENT PACKING	UV/PCB
FTC250163	Ø 6/12 mm	ABS	Vrac / Bulk	24/144



WAVY CAPS

Taille-crayons 1 usage - 1-Hole pencil sharpener

Pour des crayons de Ø 6 à Ø 8 mm - For Ø 6 to Ø 8 mm pencils

Mini réserve clipsée - Clip-on bin

Corps plastique bi-matière + clapet de fermeture - Bi-material plastic body + closing flap

Taille-crayons plastique - Plastic sharpener

Livré en boîte de 20 pcs - Delivered in box of 20 pcs

REF.	TAILLE SIZE	CARACTÉRISTIQUES SPECIFICATIONS	CONDITIONNEMENT PACKING	UV/PCB
FTC150281	Ø 6/8 mm	PS-PP-TPR	Vrac / Bulk	20/1200



WAVY

Taille-crayons 1 usage - 1-Hole pencil sharpener

Pour des crayons de Ø 6 à Ø 8 mm - For Ø 6 to Ø 8 mm pencils

Corps plastique bi-matière - Bi-material plastic body

Taille-crayons plastique - Plastic sharpener

Livré en boîte de 24 pcs - Delivered in box of 24 pcs

REF.	TAILLE SIZE	CARACTÉRISTIQUES SPECIFICATIONS	CONDITIONNEMENT PACKING	UV/PCB
FTC100681	Ø 6/8 mm	PP-TPR	Vrac / Bulk	24/576



TAILLE-CRAYONS ALU 2 USAGES 2-Holes aluminium pencil sharpener

Pour des crayons de Ø 6 à Ø 12 mm - For Ø 6 to Ø 12 mm pencils

REF.	TAILLE SIZE	CARACTÉRISTIQUES SPECIFICATIONS	CONDITIONNEMENT PACKING	UV/PCB
FTC200073	Ø 6/12 mm	Aluminium	Vrac / Bulk	20/600



TAILLE-CRAYONS ALU 1 USAGE 1-Hole aluminium pencil sharpener

Pour des crayons de Ø 6 à Ø 8 mm - For Ø 6 to Ø 8 mm pencils

REF.	TAILLE SIZE	CARACTÉRISTIQUES SPECIFICATIONS	CONDITIONNEMENT PACKING	UV/PCB
FTC100173	Ø 6/8 mm	Aluminium	Vrac / Bulk	20/600
FTC100972	Ø 6/8 mm	Aluminium	LS / pegbordable	10/600



TAILLE-CRAYONS ALU 1 USAGE «VIOLON» 1-Hole aluminium pencil sharpener «violin»

Pour des crayons de Ø 6 à Ø 8 mm - For Ø 6 to Ø 8 mm pencils

REF.	TAILLE SIZE	CARACTÉRISTIQUES SPECIFICATIONS	CONDITIONNEMENT PACKING	UV/PCB
FTC100073	Ø 6/8 mm	Aluminium	Vrac / Bulk	20/600

DÉCOUPER - TAILLER

Cut - Sharpen

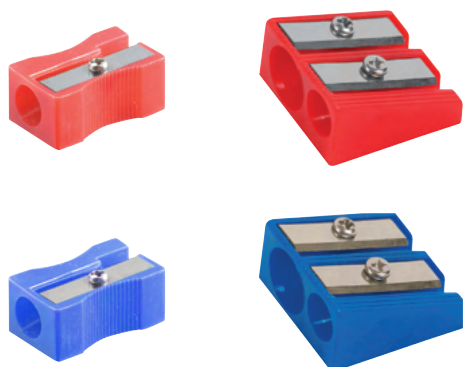

TAILLE-CRAYONS PLASTIQUE Plastic pencil sharpener

Taille-crayons 2 et 1 usages - 2 and 1-Holes pencil sharpener
Pour des crayons de Ø 6 à Ø 12 mm - For Ø 6 to Ø 12 mm pencils

REF.	TAILLE SIZE	CARACTÉRISTIQUES SPECIFICATIONS	CONDITIONNEMENT PACKING	LIV/PCB
FTC200361	Ø 6/8/12 mm	ABS	Vrac / Bulk	24/1440
FTC100461	Ø 6/8 mm	ABS	Vrac / Bulk	24/144

TAILLE-CRAYONS PLASTIQUE GROS CRAYONS Plastic pencil sharpener for large pencils

Taille-crayons 1 usage - 1-Hole pencil sharpener
Pour des crayons de Ø 12 à Ø 17 mm - For Ø 12 to Ø 17 mm pencils

REF.	TAILLE SIZE	CARACTÉRISTIQUES SPECIFICATIONS	CONDITIONNEMENT PACKING	LIV/PCB
FTC100563	Ø 12/17 mm	PP	Vrac / Bulk	10/1000

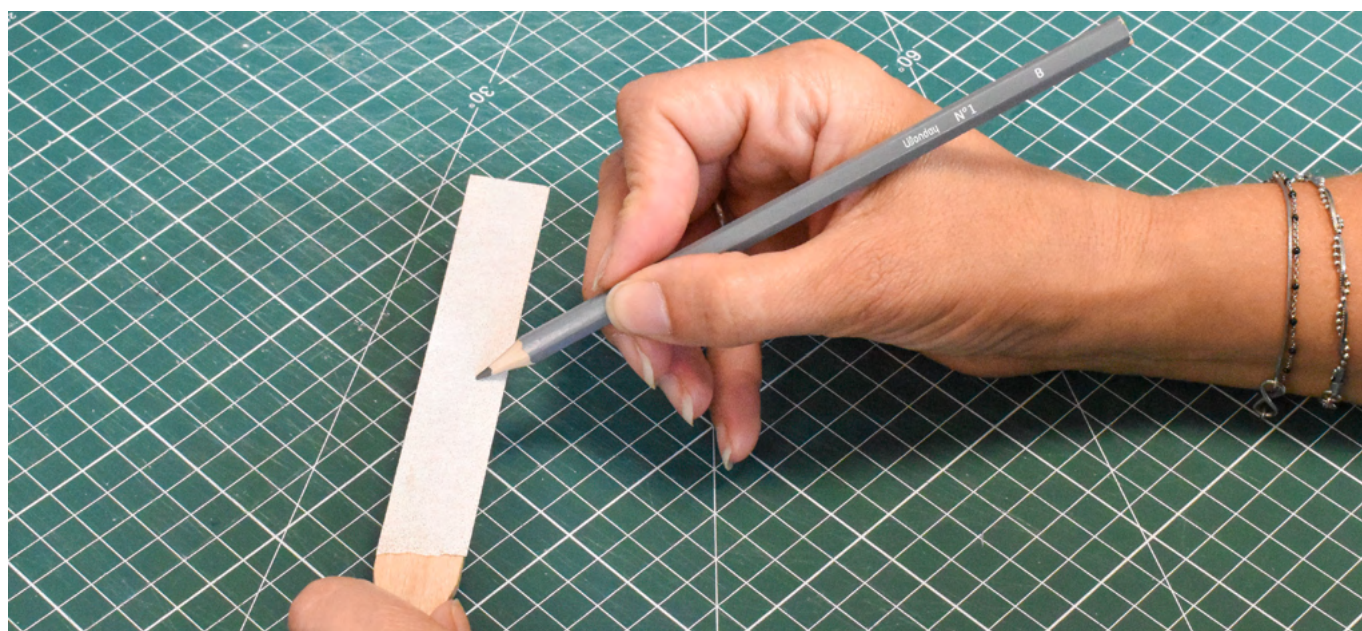

AFFÛTOIR EN BOIS Wooden sharpener



Pour retailler la pointe des crayons - For pencils' tip repointing
2 faces abrasives - 2 abrasive sides

REF.	TAILLE SIZE	CARACTÉRISTIQUES SPECIFICATIONS	CONDITIONNEMENT PACKING	LIV/PCB
FTC900041	20 cm	Bois brut Raw wood	Vrac / Bulk	24/144



AGRAFEUSES / STAPLERS



AGRAFEUSE ÉLECTRIQUE 24/6 26/6 24/6 26/6 electric stapler

Capacité d'agrafage : 15 à 20 feuilles - Stapling capacity : 15 to 20 sheets
 Chargement frontal des agrafes - Front-loading staples
 Système d'ouverture du chargement des agrafes par bouton poussoir au dos - Staple opening loading system by a back push-button
 Fonctionne sur secteur (cordon d'alimentation fourni) - Works on mains supply (power cord included)
 Agrafes non incluses - Staples not included



REF.	TAILLE SIZE	CARACTÉRISTIQUES SPECIFICATIONS	CONDITIONNEMENT PACKING	UV/PCB
FAG240563*	24/6 26/6	ABS	Boîte / Box	1/24

* Jusqu'à épaisseur des stocks



AGRAFEUSE GRANDE CAPACITÉ 23/10 23/10 heavy duty stapler

Agrafeuse bi-matière - Bi-material stapler
 Capacité d'agrafage : 60 feuilles - Stapling capacity : 60 sheets
 Base renforcée - Reinforced base
 + 1 boîte de 1000 agrafes 23/10 - + 1 box of 1000 23/10 staples

REF.	TAILLE SIZE	CARACTÉRISTIQUES SPECIFICATIONS	CONDITIONNEMENT PACKING	UV/PCB
FAG500083	23/10	ABS-TPR	Boîte / Box	1/12

Agrafes Staples - Grapas	Taille Size Tamaño	Capacité - Capacity - Capacidad 60g/m ² 80g/m ²
	23/6	25 15
	23/8	50 30
	23/10	75 50
	23/13	100 80
	23/15	125 100
	23/17	150 120
	23/20	190 150
	23/24	240 210

Feuilles - Sheets - Hojas

POUR LES GROS TRAVAUX



AGRAFEUSE TRÈS GRANDE CAPACITÉ DE 23/6 À 23/24 From 23/6 to 23/24 heavy duty stapler

Agrafeuse épingieuse bi-matière - Bi-material fastening stapler
 Capacité d'agrafage : 200 feuilles - Stapling capacity : 200 sheets
 Système d'ouverture du chargement des agrafes par bouton poussoir sur le dessus - Staple opening loading system by a back push-button
 Agrafes non incluses - Staples not included

REF.	TAILLE SIZE	CARACTÉRISTIQUES SPECIFICATIONS	CONDITIONNEMENT PACKING	UV/PCB
FAG500183	23/6 23/24	ABS-TPR	Boîte / Box	1/6

AGRAFER - PERFORER - ASSEMBLER

Staple - Perforate - Assemble

100



Agrafes - Staples - Grapas - Grampos - Punti - Heftklammern - Nietjes		Capacité - Capacity - Capacidad - Capacidade - Capazität - Kapazität - Capaciteit	
6mm	23/62	- 20	Feuilles Sheets Hojas Folhas Fogli Blätter bladeren
8mm	23/8	25 - 50	
10mm	23/10	50 - 70	
13mm	23/13	70 - 100	

AGRAFEUSE LONG BRAS GRANDE CAPACITÉ DE 23/6 À 23/13 From 23/6 to 23/13 heavy duty long arm stapler

Agrafeuse épingleuse - Fastening stapler
Capacité d'agrafage : 100 feuilles - Stapling capacity : 100 sheets
Profondeur d'agrafage : 215 mm - Stapling depth : 215 mm
Agrafes non incluses - Staples not included

REF.	TAILLE SIZE	CARACTÉRISTIQUES SPECIFICATIONS	CONDITIONNEMENT PACKING	UV/PCB
FAG300173	23/6 23/13	ABS-Métal ABS-Metal	  Boîte / Box	1/6

ELLES ONT LE BRAS LONG !

15



AGRAFEUSE LONG BRAS DE 24/6 À 26/6 From 24/6 to 26/6 long arm stapler

Agrafeuse épingleuse - Fastening stapler
Capacité d'agrafage : 15 feuilles - Stapling capacity : 15 sheets
Profondeur d'agrafage : 300 mm - Stapling depth : 300 mm
Agrafes non incluses - Staples not included



REF.	TAILLE SIZE	CARACTÉRISTIQUES SPECIFICATIONS	CONDITIONNEMENT PACKING	UV/PCB
FAG300073	24/6 26/6	ABS Métal / Metal	  Boîte / Box	1/24

**IDÉALE POUR
LES BROCHURES**



AGRAFEUSE ROTATIVE N°10 Rotating n°10 stapler

Agrafeuse bi-matière anti-glisse - Anti-slip bi-material stapler
Capacité d'agrafage : 12 feuilles - Stapling capacity : 12 sheets
Profondeur d'agrafage : 60 mm - Stapling depth : 60 mm
2 positions d'agrafage : « Classique » ou « Brochure » - 2 stapling positions :
« Regular » or « Leaflets »
Agrafes non incluses - Staples not included

REF.	TAILLE SIZE	CARACTÉRISTIQUES SPECIFICATIONS	CONDITIONNEMENT PACKING	UV/PCB
FAG100362	n°10	ABS	  LS / Pegboardable	12/120

AGRAFER - PERFORER - ASSEMBLER

Staple - Perforate - Assemble



AGRAFEUSE SANS AGRAFES Stapleless stapler

Capot plastique - Plastic top
Capacité d'agrafage : 4 feuilles - Stapling capacity : 4 sheets

REF.	TAILLE SIZE	CARACTÉRISTIQUES SPECIFICATIONS	CONDITIONNEMENT PACKING	LIV/PCB
FAG600063	-	ABS 	LS / Pegboardable	12/288



NE FORCEZ PLUS !



PINCE AGRAFEUSE « SANS EFFORT » 24/6 26/6 24/6 26/6 « low-force » plier stapler



50% d'effort en moins - 50% less effort
Capot plastique ABS, corps métal - ABS plastic top, metal body
Capacité d'agrafage : 20 à 25 feuilles - Stapling capacity : 20 to 25 sheets
+ 1 boîte de 1000 agrafes 24/6 - + 1 box of 1000 24/6 staples

REF.	TAILLE SIZE	CARACTÉRISTIQUES SPECIFICATIONS	CONDITIONNEMENT PACKING	LIV/PCB
FAG240462	24/6 26/6	ABS 	LS / Pegboardable	12/48



PINCE AGRAFEUSE P3 SP19 1/4 Plier stapler P3 SP19 1/4

Capacité d'agrafage : 20 feuilles - Stapling capacity : 20 sheets
Chargement par le dessus - Top loading
Agrafes non incluses - Staples not included

REF.	TAILLE SIZE	CARACTÉRISTIQUES SPECIFICATIONS	CONDITIONNEMENT PACKING	LIV/PCB
8470.19 CH	SP19 1/4	Métal chromé Chromed metal 	LS / Pegboardable	1/48
8470.19 GR	SP19 1/4	Métal / Metal 	LS / Pegboardable	1/48
9619.06	SP19 1/4 x 5000	Acier galvanisé / Galvanized steel 	Boîte / Box	1/40

* Distribution France (DOM-TOM inclus) uniquement.
Retail France (including DOM-TOM) only.

AGRAFER - PERFORER - ASSEMBLER

Staple - Perforate - Assemble



MINI PINCE AGRAFEUSE N°10 n°10 mini plier staplers

Tout métal - All metal

Capacité d'agrafage : 20 feuilles - Stapling capacity : 20 sheets

Livré en boîte de 18 pcs - Delivered in a box of 18 pcs

Agrafes non incluses - Staples not included

REF.	TAILLE SIZE	CARACTÉRISTIQUES SPECIFICATIONS	CONDITIONNEMENT PACKING	UV/PCB
FAG100573	n°10	Métal / Metal  	LS / Pegboardable	18/108

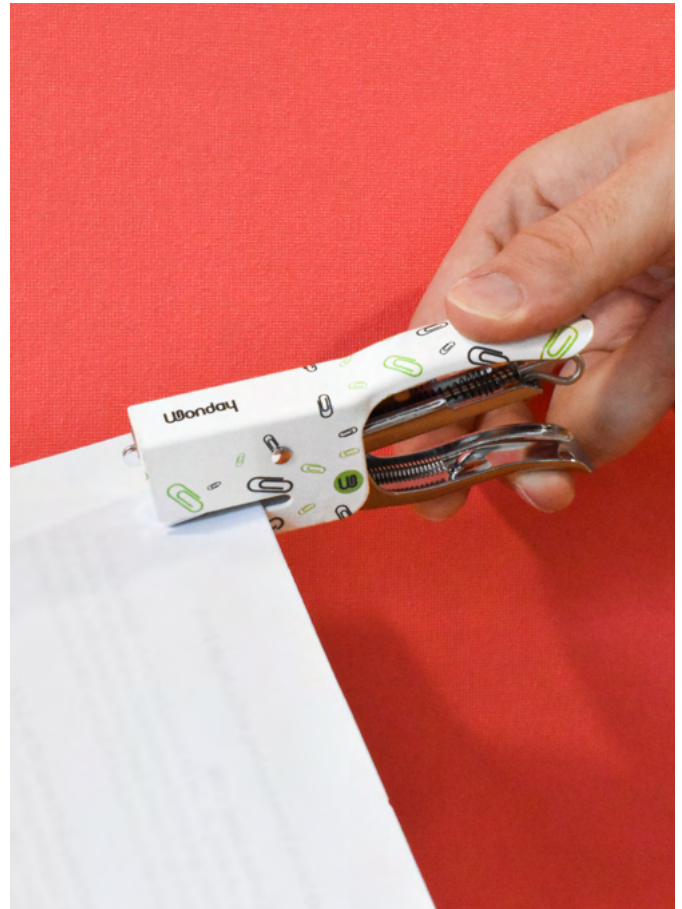

PINCES AGRAFEUSES « VIVA » N°10 ET 8/4 « Viva » 8/4 and n°10 plier staplers

Agrafeuse épingleuse - Fastening stapler

Capot plastique, corps métal - Plastic top, metal body

Capacité d'agrafage : 10 feuilles - Stapling capacity : 10 sheets

Agrafes non incluses - Staples not included







REF.	TAILLE SIZE	CARACTÉRISTIQUES SPECIFICATIONS	CONDITIONNEMENT PACKING	UV/PCB
FAG100883	n°10	PP Métal / Metal  	LS / Pegboardable	12/48
FAG080262	8/4	PP Métal / Metal  	LS / Pegboardable	12/48



PINCE AGRAFEUSE « INITIAL » « Initial » plier stapler

Capot plastique ABS, corps métal - ABS plastic top, metal body

Agrafes non incluses - Staples not included

REF.	TAILLE SIZE	CARACTÉRISTIQUES SPECIFICATIONS	CONDITIONNEMENT PACKING	UV/PCB
FAG240382	24/6 26/6	ABS Métal / Metal  	LS / Pegboardable	12/48
FAG100482	n°10	ABS Métal / Metal  	LS / Pegboardable	12/96
FAG080082	8/4	ABS Métal / Metal  	LS / Pegboardable	12/96

AGRAFER - PERFORER - ASSEMBLER

Staple - Perforate - Assemble



AGRAFEUSE DE BUREAU « INITIAL » 24/6 26/6 « Initial » 24/6 26/6 desk stapler

Capot plastique ABS, mécanisme métal - ABS plastic top, metal mechanism
Capacité d'agrafage : 20 feuilles - Stapling capacity : 20 sheets
Agrafes non incluses - Staples not included

REF.	TAILLE SIZE	CARACTÉRISTIQUES SPECIFICATIONS	CONDITIONNEMENT PACKING	UV/PCB
FAG240082	24/6 26/6	ABS Métal / Metal	 LS / Pegboardable	12/72



AGRAFEUSE DE BUREAU « CLASS'N'BURO » 24/6 26/6 « Class'n'buro » 24/6 26/6 desk stapler

Agrafeuse, épingleuse - Fastening stapler
Corps plastique ABS, mécanisme métal - ABS plastic body, metal mechanism
Agrafes non incluses - Staples not included

REF.	TAILLE SIZE	CARACTÉRISTIQUES SPECIFICATIONS	CONDITIONNEMENT PACKING	UV/PCB
FAG240162	24/6 26/6	ABS Métal / Metal	 LS / Pegboardable	12/72



AGRAFEUSE DE POCHE N°10 N°10 pocket stapler

Métal chromé avec support doigt plastique - Chromed metal plier stapler
Capacité d'agrafage : 10 feuilles - Stapling capacity : 10 sheets
Ôte agrafes intégré - Staple-removal function
Agrafes non incluses - Staples not included

REF.	TAILLE SIZE	CARACTÉRISTIQUES SPECIFICATIONS	CONDITIONNEMENT PACKING	UV/PCB
FAG100272	n°10	ABS Métal / Metal	 LS / Pegboardable	12/144



AGRAFEUSE DE POCHE N°10 N°10 pocket stapler

Corps plastique ABS, mécanisme métal - ABS plastic body, metal mechanism
Capacité d'agrafage : 12 feuilles - Stapling capacity : 12 sheets
Ôte agrafes intégré - Staple-removal function
+ 1 boîte de 1000 agrafes n°10 - + 1 box of 1000 n°10 staples

REF.	TAILLE SIZE	CARACTÉRISTIQUES SPECIFICATIONS	CONDITIONNEMENT PACKING	UV/PCB
FAG100162	n°10	ABS Métal / Metal	 LS / Pegboardable	12/120



MINI AGRAFEUSE DE POCHE N°10 Mini n°10 pocket stapler

Corps plastique, mécanisme métal - Plastic body, metal mechanism
Capacité d'agrafage : 15 feuilles - Stapling capacity : 15 sheets
Ôte-agrapes intégré - Staple-removal function
+ 1 boîte de 1000 agrafes n°10 - + 1 box of 1000 n°10 staples

REF.	TAILLE SIZE	CARACTÉRISTIQUES SPECIFICATIONS	CONDITIONNEMENT PACKING	UV/PCB
FAG100062	n°10	PP Métal / Metal	 LS / Pegboardable	12/144



AGRAFEUSE DE POCHE 24/6 26/6 24/6 26/6 pocket stapler

Corps plastique, mécanisme métal - Plastic body, metal mechanism
Capacité d'agrafage : 12 feuilles - Stapling capacity : 12 sheets
Ôte-agrapes intégré - Staple-removal function

REF.	TAILLE SIZE	CARACTÉRISTIQUES SPECIFICATIONS	CONDITIONNEMENT PACKING	UV/PCB
FAG240762	24/6 26/6	ABS Métal / Metal	 LS / Pegboardable	20/240

AGRAFER - PERFORER - ASSEMBLER

Staple - Perforate - Assemble

ÔTE-AGRAFES / STAPLES REMOVER



PINCE ÔTE-AGRAFES
Plier staples' remover

Tout métal - All metal

REF.	CARACTÉRISTIQUES SPECIFICATIONS	CONDITIONNEMENT PACKING	LIV/PCB
FOT020072	Métal / Metal 	LS Pegboardable	1/144



ÔTE-AGRAFES
Staples' remover

Corps plastique ABS, mécanisme métal - Plastic body, metal mechanism

REF.	CARACTÉRISTIQUES SPECIFICATIONS	CONDITIONNEMENT PACKING	LIV/PCB
FOT010061	ABS Métal / Metal 	Vrac Bulk	24/288



ÔTE-AGRAFES
Staples' remover

Corps plastique ABS, mécanisme métal - Plastic body, metal mechanism
Système de blocage - Locking system

REF.	CARACTÉRISTIQUES SPECIFICATIONS	CONDITIONNEMENT PACKING	LIV/PCB
FOT010162	ABS Métal / Metal 	LS Pegboardable	12/288

AGRAFER - PERFORER - ASSEMBLER

Staple - Perforate - Assemble



AGRAFES / STAPLES



MODÈLE MODEL	REF.	QUANTITÉ QUANTITY	CARACTÉRISTIQUES SPECIFICATIONS		CONDITIONNEMENT PACKING	LV/PCB
	FAF080073	x 1000	Galvanisée / Galvanized		Boîte / Box	50/500
N°8/4	FAF080173	x 5000	Galvanisée / Galvanized		Boîte / Box	10/-
	9608.45*	x 5000	Cuivrée / Copper plated		Boîte / Box	20/100
	FAF100073	x 1000	Galvanisée / Galvanized		Boîte / Box	50/500
N°10	FAF100173	x 5000	Galvanisée / Galvanized		Boîte / Box	10/100
n°19 1/4	9619.45*	x 5000	Galvanisée / Galvanized		Boîte / Box	20/100
n° 66/6e	9666.65*	x 5000	Galvanisée / Galvanized		Boîte / Box	20/100
n° 23/6	FAF230073	x 1000	Galvanisée / Galvanized		Boîte / Box	20/200
n° 23/8	FAF230173	x 1000	Galvanisée / Galvanized		Boîte / Box	20/200
n° 23/10	FAF230273	x 1000	Galvanisée / Galvanized		Boîte / Box	10/100
n° 23/20	9623.20*	x 1000	Galvanisée / Galvanized		Boîte / Box	10/60
	FAF240073	x 1000	Galvanisée / Galvanized		Boîte / Box	50/200
n° 24/6	FAF240173	x 5000	Galvanisée / Galvanized		Boîte / Box	10/50
	FAF260073	x 1000	Galvanisée / Galvanized		Boîte / Box	50/400
n° 26/6	FAF260173	x 5000	Galvanisée / Galvanized		Boîte / Box	10/80
n° 26/8	FAF260273	x 5000	Galvanisée / Galvanized		Boîte / Box	10/50

* Jusqu'à épuisement des stocks

AGRAFER - PERFORER - ASSEMBLER

Staple - Perforate - Assemble



PERFORATEURS / PUNCHES



PERFORATEUR «CLASS'N'BURO» 4 TROUS «Class'n buro» 4 holes punch



Tout métal - All metal
Capacité perforation : 20 feuilles - Punching capacity : 20 sheets
Système de blocage - Locking system
Écartement 80 mm - 80 mm space between holes
Réglette de guidage - Paper positioning guide

REF.	CARACTÉRISTIQUES SPECIFICATIONS	CONDITIONNEMENT PACKING	UV/PCB
FPE040172	Métal / Metal  	LS Pegboardable	1/12



PERFORATEURS «CLASS'N'BURO» 2 TROUS «Class'n buro» 2 holes punches

Tout métal - All metal
Écartement 80 mm - 80 mm space between holes
Réglette de guidage - Paper positioning guide

REF.	CARACTÉRISTIQUES SPECIFICATIONS	CONDITIONNEMENT PACKING	UV/PCB
FPE020372	Métal / Metal  	LS Pegboardable	1/12
FPE020472*	Métal / Metal  	LS Pegboardable	1/12
FPE020273	Métal / Metal  	LS Pegboardable	12/60
FPE020172	Métal / Metal  	LS Pegboardable	12/72

* Jusqu'à épaisseur des stocks

AGRAFER - PERFORER - ASSEMBLER

Staple - Perforate - Assemble



PERFORATEUR «CLASS'N'BURO» 2 TROUS «Class'n buro» 2 holes punch



Corps plastique PP, base métal - PP plastic body, metal basis
Lever renforcé - Strengthened control lever
Capacité perforation : 20 feuilles - Punching capacity : 20 sheets
Écartement 80 mm - 80 mm space between holes
Réglette de guidage - Paper positioning guide

REF.	CARACTÉRISTIQUES SPECIFICATIONS	CONDITIONNEMENT PACKING	LIV/PCB
FPE020072	PP Métal / Metal	20	LS / Pegboardable 1/48



PERFORATEUR 4 TROUS 4 holes punch



Tout métal - All metal
Capacité perforation : 20 feuilles - Punching capacity : 20 sheets
Système de blocage - Locking system
Écartement 80 mm - 80 mm space between holes
Réglette de guidage - Paper positioning guide

REF.	CARACTÉRISTIQUES SPECIFICATIONS	CONDITIONNEMENT PACKING	LIV/PCB
FPE040072	Métal / Metal	20	LS / Pegboardable 1/12



PERFORATEUR 2 TROUS 2 holes punch



Corps plastique PP, base métal - PP plastic body, metal basis
Capacité perforation : 10 feuilles - Punching capacity : 10 sheets
Réglette de guidage - Paper positioning guide

REF.	CARACTÉRISTIQUES SPECIFICATIONS	CONDITIONNEMENT PACKING	LIV/PCB
FPE020662	PP Métal / Metal	10	LS / Pegboardable 12/72



PERFORATEUR 1 TROU 1 hole punch



Tout métal - All metal
Capacité perforation : 20 feuilles - Punching capacity : 20 sheets
Écartement 80 mm - 80 mm space between holes
Réglette de guidage - Paper positioning guide

REF.	CARACTÉRISTIQUES SPECIFICATIONS	CONDITIONNEMENT PACKING	LIV/PCB
FPE010072	Métal / Metal	20	LS / Pegboardable 12/144

AGRAFER - PERFORER - ASSEMBLER

Staple - Perforate - Assemble

DÉVIDOIRS / TAPE DISPENSERS



DÉVIDOIR AUTOMATIQUE D'ADHÉSIF Automatic tape dispenser



Utilisable d'une seule main - Single-handed operation
 Corps plastique PS - PS plastic body
 Lame microdentée en acier avec capot de protection
 Serrated steel blade with protective cover
 Pour rouleaux 19 mm x 20 m - For 19 mm x 20 m tape rolls
 + 3 rouleaux de ruban adhésif inclus - + 3 tape rolls included

REF.	CARACTÉRISTIQUES SPECIFICATIONS	CONDITIONNEMENT PACKING	LV/PCB
FAD950162	PS/PP 	LS Pegboardable	12/72



BOÎTE DE 4 ROULEAUX D'ADHÉSIF 19 MM X 20 M Box of 4 rolls of 19 mm x 20 m adhesive

43 µ transparent BOPP - 43 µ BOPP transparent

REF.	DIMENSIONS	CARACTÉRISTIQUES SPECIFICATIONS	CONDITIONNEMENT PACKING	LV/PCB
FAD101213	19 mm x 20 m	BOPP	Boîte de 4 rouleaux Box of 4 rolls	10/100

AGRAFER - PERFORER - ASSEMBLER

Staple - Perforate - Assemble



DÉVIDOIR DE BUREAU

Desk tape dispenser

Socle lesté et patins anti-dérapants - Weighted base and antislip feet
Lame microdentée en acier - Serrated steel blade
Pour rouleaux 19 mm x 33 m et 66 m - For 19 mm x 33 m and 66 m tape rolls
Adhésif non inclus - Adhesive not included

REF.	DIMENSIONS	CARACTÉRISTIQUES SPECIFICATIONS	CONDITIONNEMENT PACKING	LIV/PCB
GAD900063	215 x 85 x 104 mm	PP	Boîte / Box	1/8

DÉVIDOIR DE BUREAU « BÛCHE »

« Log » desk tape dispenser

Socle lesté et patins anti-dérapants - Weighted base and antislip feet
Lame microdentée en acier - Serrated steel blade
Pour rouleaux 19 mm x 33 m - For 19 mm x 33 m tape rolls
Adhésif non inclus - Adhesive not included

REF.	DIMENSIONS	CARACTÉRISTIQUES SPECIFICATIONS	CONDITIONNEMENT PACKING	LIV/PCB
FAD900563	143 x 61 x 56 mm	ABS	Boîte / Box	1/24



DÉVIDOIR DE BUREAU

Desk tape dispenser

Socle lesté et patins anti-dérapants - Weighted base and antislip feet
Lame microdentée en acier - Serrated steel blade
Pour rouleaux 19 mm x 33 m - For 19 mm x 33 m tape rolls
Adhésif non inclus - Adhesive not included

REF.	DIMENSIONS	CARACTÉRISTIQUES SPECIFICATIONS	CONDITIONNEMENT PACKING	LIV/PCB
FAD900363	143 x 60 x 90 mm	PP	Boîte / Box	1/24



DÉVIDOIR « ESCARGOT »

« Snail » tape dispenser

Corps plastique PS - PS plastic body
Lame microdentée en acier - Serrated steel blade
Pour rouleaux 19 mm x 33 m - For 19 mm x 33 m tape rolls
+ 1 rouleau de ruban adhésif inclus - + 1 tape roll included

REF.	CARACTÉRISTIQUES SPECIFICATIONS	CONDITIONNEMENT PACKING	LIV/PCB
FAD950062	PS	LS Pegboardable	12/144

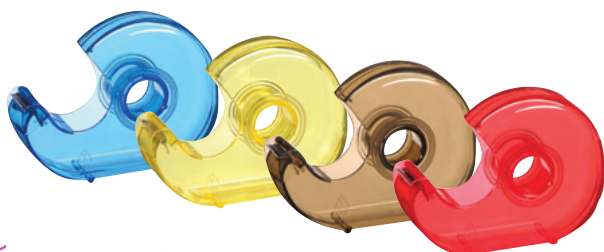

DÉVIDOIR « ESCARGOT »

« Snail » tape dispenser

Corps plastique PS - PS plastic body
Lame microdentée en acier - Serrated steel blade
Pour rouleaux 19 mm x 33 m - For 19 mm x 33 m tape rolls
Adhésif non inclus - Adhesive not included

REF.	CARACTÉRISTIQUES SPECIFICATIONS	CONDITIONNEMENT PACKING	LIV/PCB
FAD900191	PS	Vrac Bulk	20/300



DÉVIDOIR « ESCARGOT »

« Snail » tape dispenser

Corps plastique PS - PS plastic body
Lame microdentée en acier - Serrated steel blade
Pour rouleaux 19 mm x 33 m - For 19 mm x 33 m tape rolls
Adhésif non inclus - Adhesive not included

REF.	CARACTÉRISTIQUES SPECIFICATIONS	CONDITIONNEMENT PACKING	LIV/PCB
FAD900062	PS	LS Pegboardable	12/144

AGRAFER - PERFORER - ASSEMBLER

Staple - Perforate - Assemble



DÉVIDOIR « ESCARGOT » « Snail » tape dispenser

Corps plastique PS - PS plastic body
Lame microdentée en acier - Serrated steel blade
Pour rouleaux 19 mm x 33 m - For 19 mm x 33 m tape rolls
Adhésif non inclus - Adhesive not included

REF.	CARACTÉRISTIQUES SPECIFICATIONS	CONDITIONNEMENT PACKING	LIV/PCB
FAD900261	PS 	Vrac / Bulk	12/288

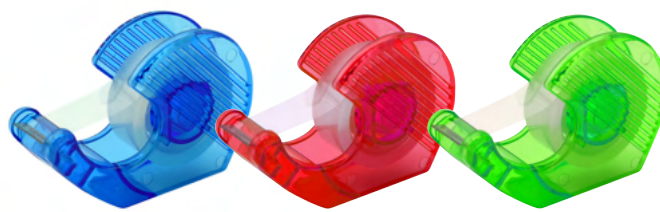

DÉVIDOIR « ESCARGOT » « Snail » tape dispenser

Corps plastique PS - PS plastic body
Lame microdentée en acier - Serrated steel blade
Pour rouleaux 19 mm x 33 m - For 19 mm x 33 m tape rolls
Adhésif non inclus - Adhesive not included

REF.	CARACTÉRISTIQUES SPECIFICATIONS	CONDITIONNEMENT PACKING	LIV/PCB
FAD900691	PS 	Vrac / Bulk	12/288

ROULEAUX DE RUBAN ADHÉSIF / ADHESIVE TAPE



TRANSPARENT













INVISIBLE



TRANSPARENT



ÉCO

MODÈLE MODEL	REF.	ÉPAISSEUR THICKNESS	CONDITIONNEMENT PACKING	CARACTÉRISTIQUES SPECIFICATIONS	LIV/PCB
25 mm x 66 m	FAD101111	46 microns	BOPP	 Transparent	Vrac / Bulk 6/72
19 mm x 66 m	FAD100911	46 microns	BOPP	 Transparent	Vrac / Bulk 8/96
	FAD100011	43 microns	BOPP	 Transparent	LS / Pegboardable 8/96
12 mm x 66 m	FAD100611	46 microns	BOPP	 Transparent	Vrac / Bulk 12/288
19 mm x 33 m	FAD000011	50 microns	BOPP	 Invisible	Lot de 4 / Set of 4 1/100
	FAD000211	48 microns	BOPP	 Invisible	Vrac / Bulk 8/192
	FAD100211	48 microns	BOPP	 Transparent	Boîte / Box 24/192
	FAD100111	43 microns	BOPP	 Transparent	Lot de 8 / Set of 8 1/72
	FAD100311	40 microns	BOPP	 Transparent	Vrac / Bulk 8/192
	FAD100411	35 microns	BOPP	 Eco	Vrac / Bulk 8/192
19 mm x 20 m	FAD101213 (pour FAD950162)	43 microns	BOPP	 Transparent	Boîte de 4 rouleaux Box of 4 rolls 10/100

FIXATIONS / FIXATIONS



**COLLÉS
SERRÉS**



RUBAN DE SCRATCH AUTO-AGRIPPANT « EASY SCRATCH » « EASY Scratch » self-gripping hook and loop tape

Multi-usages intérieur et extérieur - Multi-purposes for indoor and outdoor
Réversible et réutilisable - Reversible and reusable
Ultra résistant à la traction - Ultra tensile resistant

REF.	DIMENSIONS	CARACTÉRISTIQUES SPECIFICATIONS	CONDITIONNEMENT PACKING	LIV/PCB
BFI100002	20 mm x 2.5 m	Nylon 	LS / Pegboardable	6/144
BFI100102	20 mm x 2.5 m	Nylon 	LS / Pegboardable	6/144



100g PÂTE ADHÉSIVE Tack glue dots 100g

Réutilisable et multi-usages - Reusable and Multi-purpose
Toutes surfaces - Any surface
Pré-découpée - Precut



REF.	CARACTÉRISTIQUES SPECIFICATIONS	CONDITIONNEMENT PACKING	LIV/PCB
FAD500012	100g 	LS / Pegboardable	20/120



Boîte rechargeable
Refillable box

ASSORTIMENT DE 6 ARTICLES DE FIXATION « I KIT » 6 fasteners assortment « I Kit »

Composition : 80 trombones 28 mm + 25 trombones 50 mm + 150 punaises synthétique 50 x 3 mm
Composition : 80 paperclips 28 mm + 25 paperclips 50 mm + 150 thumb tacks + 40 push pins + 10 binder clips 19 mm + 15g de caoutchouc synthétique 50 x 3 mm

Composition : 80 paperclips 28 mm + 25 paperclips 50 mm + 150 thumb tacks + 40 push pins + 10 binder clips 19 mm + 15g synthetic rubber bands 50 x 3 mm

REF.	CARACTÉRISTIQUES SPECIFICATIONS	CONDITIONNEMENT PACKING	LIV/PCB
FFI500092	Ø 140 x 30 mm 	LS / Pegboardable	6/36

AGRAFER - PERFORER - ASSEMBLER

Staple - Perforate - Assemble



Boîte / Box



LS / Pegboardable

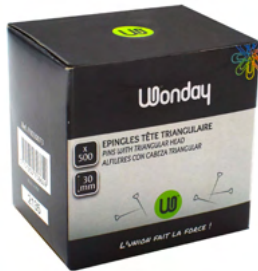

Boîte / Box



LS / Pegboardable



Boîte / Box



LS / Pegboardable



PUNAISES Tacks

MODÈLE MODEL	REF.	QUANTITÉ QUANTITY	CARACTÉRISTIQUES SPECIFICATIONS	CONDITIONNEMENT PACKING	LIV/PCB
Dorées Gold-plated Ø 10 mm	FFI000073	x 100	Acier doré / Gold plated		Boîte / Box
	FFI000672				LS / Pegboardable
3 pointes 3 pins Ø 12 mm	FFI000173	x 100	Acier nickelé / Nickerled plated		Boîte / Box
	FFI000872				LS / Pegboardable
Baïonnette Ø 10 mm	FFI000373	x 100	Acier nickelé / Nickerled plated		Boîte / Box
Couleurs Coloured Ø 10 mm	FFI000293	x 100	Acier doré / Gold plated Capot plastique PVC PVC Plastic caps		Boîte / Box
	FFI000592				LS / Pegboardable
Signalétiques Push pins Ø 10 x 23 mm	FFI000493	x 100	Acier nickelé / Nickerled plated Capot plastique PVC PVC Plastic caps		Boîte / Box
	FFI000892	x 36			LS / Pegboardable

ÉPINGLES Map pins



MODÈLE MODEL	REF.	QUANTITÉ QUANTITY	CARACTÉRISTIQUES SPECIFICATIONS	CONDITIONNEMENT PACKING	LIV/PCB
Tête ronde Map pins Ø 4 mm	FFI010292	x 50	Acier nickelé / Nickerled plated Tête plastique ABS ABS Plastic head		LS / Pegboardable
Triangulaire n°2 x 30 mm	FFI010073	x 500	Acier nickelé / Nickerled plated		Boîte / Box

ATTACHES PARISIENNES Paper fasteners



MODÈLE MODEL	REF.	QUANTITÉ QUANTITY	CARACTÉRISTIQUES SPECIFICATIONS	CONDITIONNEMENT PACKING	LIV/PCB
16 - 19 - 25 mm	FFI050872	x 40	Acier nickelé / Nickerled plated		LS / Pegboardable
14 - 19 - 31 mm	FFI050972	x 30	Acier nickelé / Nickerled plated		LS / Pegboardable
16 mm	FFI050073	x 100	Acier doré / Gold plated		Boîte / Box
16 mm	FFI050572	x 40	Acier doré / Gold plated		LS / Pegboardable
19 mm	FFI050672	x 40	Acier doré / Gold plated		LS / Pegboardable
20 mm	FFI050173	x 100	Acier doré / Gold plated		Boîte / Box
30 mm	FFI050273	x 100	Acier doré / Gold plated		Boîte / Box



BRACELETS CAOUTCHOUC / RUBBER BANDS



BALLE D'ÉLASTIQUES FLUOS Neon rubber bands ball

REF.	TAILLE SIZE	CARACTÉRISTIQUES SPECIFICATIONS	CONDITIONNEMENT PACKING	UV/PCB
FEL000692	Ø 38 mm	Caoutchouc synthétique Synthetic rubber	LS / Pegboardable	12/72



LS / Pegboardable



BRACELETS CAOUTCHOUC COULEUR Colour rubber bands

MODÈLE MODEL	REF.	TAILLE SIZE	QUANTITÉ QUANTITY	CARACTÉRISTIQUES SPECIFICATIONS	CONDITIONNEMENT PACKING	UV/PCB
	FEL000193	Assorties Assorted	250 g	60% latex 60% compounds	Vrac / Bulk	1/40
	FEL000292	Assorties Assorted	100 g	60% latex 60% compounds	LS / Pegboardable	10/100
Couleurs Colour	FEL000392	Assorties Assorted	50 g	60% latex 60% compounds	LS / Pegboardable	10/200
	FEL000593	Assorties Assorted	20 g	60% latex 60% compounds	Vrac / Bulk	25/500
	FEL000092	Assorties Assorted	15 g	60% latex 60% compounds	LS / Pegboardable	20/120

LS / Pegboardable



Vrac / Bulk



BRACELETS CAOUTCHOUC EN CROIX H rubber bands

MODÈLE MODEL	REF.	TAILLE/ SIZE	QUANTITÉ QUANTITY	CARACTÉRISTIQUES SPECIFICATIONS	CONDITIONNEMENT PACKING	UV/PCB
160 mm	FEL250193	160 x 25 mm	x 25	60% latex 60% compounds	Vrac / Bulk	1/50
180 mm	FEL250393	180 x 25 mm	x 25	60% latex 60% compounds	Vrac / Bulk	1/50
190 mm	FEL250093	190 x 25 mm	x 10	60% latex 60% compounds	Vrac / Bulk	1/120
200 mm	FEL250293	200 x 25 mm	x 25	60% latex 60% compounds	Vrac / Bulk	1/50

AGRAFER - PERFORER - ASSEMBLER

Staple - Perforate - Assemble



STANDARD
STANDARD
(1.8 à 3 mm)



ÉTROIT
THIN
(5 à 8 mm)



LARGE
WIDE
(10 à 18 mm)

MODÈLE MODEL	REF.	LARGEUR WIDTH	QUANTITÉ QUANTITY	CARACTÉRISTIQUES SPECIFICATIONS	CONDITIONNEMENT PACKING	UV/PCB
40 mm	FEL040103	1.8 mm	1 kg	60% latex 60% compounds		Vrac / Bulk 1/10
	FEL040002	1.8 mm	100 g	60% latex 60% compounds		LS / Pegboardable 10/100
60 mm	FEL060103	1.8 mm	1 kg	60% latex 60% compounds		Vrac / Bulk 1/10
	FEL060002	1.8 mm	100 g	60% latex 60% compounds		LS / Pegboardable 10/100
70 mm	FEL070202	1.8 mm	100 g	60% latex 60% compounds		LS / Pegboardable 10/100
	FEL070103	5 mm	1 kg	60% latex 60% compounds		Vrac / Bulk 1/10
	FEL070002	5 mm	100 g	60% latex 60% compounds		LS / Pegboardable 10/100
80 mm	FEL080103	1.8 mm	1 kg	60% latex 60% compounds		Vrac / Bulk 1/10
	FEL080002	1.8 mm	100 g	60% latex 60% compounds		LS / Pegboardable 10/100
90 mm	FEL090303*	3 mm	1 kg	60% latex 60% compounds		Vrac / Bulk 1/10
	FEL090202	3 mm	100 g	60% latex 60% compounds		LS / Pegboardable 10/100
	FEL090503	5 mm	1 kg	60% latex 60% compounds		Vrac / Bulk 1/10
	FEL090402	5 mm	100 g	60% latex 60% compounds		LS / Pegboardable 10/100
	FEL090002	6 mm	100 g	60% latex 60% compounds		LS / Pegboardable 10/100
	FEL090103	6 mm	1 kg	60% latex 60% compounds		Vrac / Bulk 1/10
100 mm	FEL100103	1.8 mm	1 kg	60% latex 60% compounds		Vrac / Bulk 1/10
	FEL100002	1.8 mm	100 g	60% latex 60% compounds		LS / Pegboardable 10/100
	FEL100402	3 mm	100 g	60% latex 60% compounds		LS / Pegboardable 10/100
	FEL100202	8 mm	100 g	60% latex 60% compounds		LS / Pegboardable 10/100
110 mm	FEL110103	8 mm	1 kg	60% latex 60% compounds		Vrac / Bulk 1/10
	FEL110002	8 mm	100 g	60% latex 60% compounds		LS / Pegboardable 10/100

* Jusqu'à épaisseur des stocks

AGRAFER - PERFORER - ASSEMBLER

Staple - Perforate - Assemble

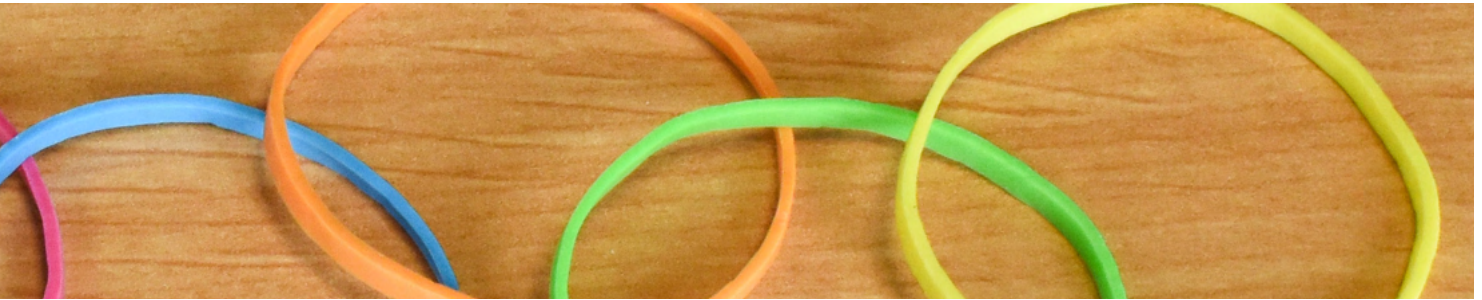

MODÈLE MODEL	REF.	LARGEUR WIDTH	QUANTITÉ QUANTITY	CARACTÉRISTIQUES SPECIFICATIONS	CONDITIONNEMENT PACKING	UV/PCB
120 mm	FEL120103	1.8 mm	1 kg	60% latex 60% compounds	Vrac Bulk	1/10
	FEL120002	1.8 mm	100 g	60% latex 60% compounds	LS Pegboardable	10/100
	FEL120402	3 mm	100 g	60% latex 60% compounds	LS Pegboardable	10/100
	FEL120303	10 mm	1 kg	60% latex 60% compounds	Vrac Bulk	1/10
	FEL120202	10 mm	100 g	60% latex 60% compounds	LS Pegboardable	10/100
150 mm	FEL150103	1.8 mm	1 kg	60% latex 60% compounds	Vrac Bulk	1/10
	FEL150002	1.8 mm	100 g	60% latex 60% compounds	LS Pegboardable	10/100
	FEL150602	3 mm	100 g	60% latex 60% compounds	LS Pegboardable	10/100
	FEL150202	6 mm	100 g	60% latex 60% compounds	LS Pegboardable	10/100
	FEL150503	10 mm	1 kg	60% latex 60% compounds	Vrac Bulk	1/10
	FEL150402	10 mm	100 g	60% latex 60% compounds	LS Pegboardable	10/100
180 mm	FEL180103	1.8 mm	1 kg	60% latex 60% compounds	Vrac Bulk	1/10
	FEL180002	1.8 mm	100 g	60% latex 60% compounds	LS Pegboardable	10/100
	FEL180303	10 mm	1 kg	60% latex 60% compounds	Vrac Bulk	1/10
	FEL180202	10 mm	100 g	60% latex 60% compounds	LS Pegboardable	10/100
200 mm	FEL200103	1.8 mm	1 kg	60% latex 60% compounds	Vrac Bulk	1/10
	FEL200002	1.8 mm	100 g	60% latex 60% compounds	LS Pegboardable	10/100
	FEL200303	10 mm	1 kg	60% latex 60% compounds	Vrac Bulk	1/10
	FEL200202	10 mm	100 g	60% latex 60% compounds	LS Pegboardable	10/100
	FEL200503	16 mm	1 kg	60% latex 60% compounds	Vrac Bulk	1/10
	FEL200402	16 mm	100 g	60% latex 60% compounds	LS Pegboardable	10/100



100 G
LS / Pegboardable



1 KG
Vrac / Bulk

AGRAFER - PERFORER - ASSEMBLER





Staple - Perforate - Assemble

DOIGTIERS / THIMBLETTES



DOIGTIERS HÉRISSEON Thimblettes



MODÈLE MODEL	REF.	QUANTITÉ QUANTITY	CARACTÉRISTIQUES SPECIFICATIONS	CONDITIONNEMENT PACKING	LIV/PCB
n°15 mm n°00	GEX000003	x 12	Caoutchouc synthétique Synthetic rubber	 Vrac / Bulk	1/250
n°17 mm n°0	GEX100003	x 12	Caoutchouc synthétique Synthetic rubber	 Vrac / Bulk	1/250
n°19 mm n°1	GEX110003	x 12	Caoutchouc synthétique Synthetic rubber	 Vrac / Bulk	1/250
n°21 mm n°2	GEX120003	x 12	Caoutchouc synthétique Synthetic rubber	 Vrac / Bulk	1/250



TROMBONES / PAPER CLIPS



x 100
Boîte / Box



TROMBONES ARRONDIS ONDULÉS Waved rounded paper clips

MODÈLE MODEL	REF.	QUANTITÉ QUANTITY	CARACTÉRISTIQUES SPECIFICATIONS	CONDITIONNEMENT PACKING	LIV/PCB
50 mm	FTB500073	x 100	Acier galvanisé / Galva- nized steel	 Boîte / Box	4/40
77 mm	FTB770073	x 100	Acier galvanisé / Galva- nized steel	 Boîte / Box	4/40



**ENTRE 2024 ET 2025
CHANGEMENT DE PACKAGING
BETWEEN 2024 AD 2025,
CHANGE OF PACKAGING**

AGRAFER - PERFORER - ASSEMBLER

Staple - Perforate - Assemble

TROMBONES ARRONDIS Rounded paper clips

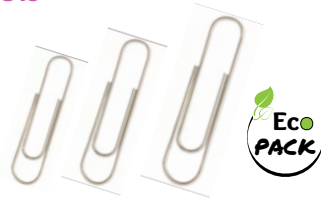

TROMBONES CHEVRON Triangular paper clips

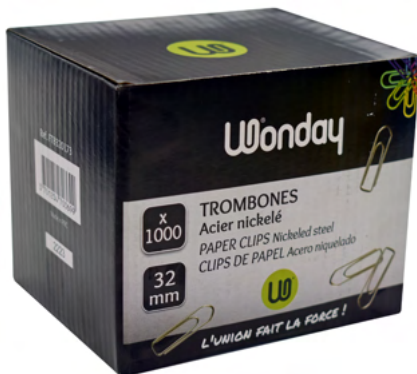

x 1000
Boîte / Box

TROMBONES ARRONDIS COULEUR Coloured rounded paper clips



MODÈLE MODEL	REF.	QUANTITÉ QUANTITY	CARACTÉRISTIQUES SPECIFICATIONS	CONDITIONNEMENT PACKING	LIV/PCB
25 mm	FTB250772	x 100	Acier galvanisé / Galva- nized steel		LS / Pegboardable 20/120
30 mm	FTB300472	x 100	Acier galvanisé / Galva- nized steel		LS / Pegboardable 20/120
32 mm	FTB320672	x 100	Acier galvanisé / Galva- nized steel		LS / Pegboardable 20/120

MODÈLE MODEL	REF.	QUANTITÉ QUANTITY	CARACTÉRISTIQUES SPECIFICATIONS	CONDITIONNEMENT PACKING	LIV/PCB
25 mm	FTB250173	x 1000	Acier nickelé / Nickerled steel		Boîte / Box 1/25
	FTB250073	x 100	Acier nickelé / Nickerled steel		Boîte / Box 10/100
	FTB250373	x 1000	Acier galvanisé / Galva- nized steel		Boîte / Box 1/25
	FTB250273	x 100	Acier galvanisé / Galva- nized steel		Boîte / Box 10/100
30 mm	FTB300173	x 1000	Acier nickelé / Nickerled steel		Boîte / Box 1/15
	FTB300073	x 100	Acier nickelé / Nickerled steel		Boîte / Box 10/100
	FTB300373	x 1000	Acier galvanisé / Galva- nized steel		Boîte / Box 1/15
	FTB300273	x 100	Acier galvanisé / Galva- nized steel		Boîte / Box 10/100
32 mm	FTB320173	x 1000	Acier nickelé / Nickerled steel		Boîte / Box 1/12
	FTB320073	x 100	Acier nickelé / Nickerled steel		Boîte / Box 10/100
	FTB320373	x 1000	Acier galvanisé / Galva- nized steel		Boîte / Box 1/12
	FTB320273	x 100	Acier galvanisé / Galva- nized steel		Boîte / Box 10/100
45 mm	FTB450073	x 100	Acier nickelé / Nickerled steel		Boîte / Box 5/100

MODÈLE MODEL	REF.	QUANTITÉ QUANTITY	CARACTÉRISTIQUES SPECIFICATIONS	CONDITIONNEMENT PACKING	LIV/PCB
25 mm	FTB250693	x 1000	Acier galvanisé peint Galvanized steel painted		Boîte / Box 1/25
	FTB250593	x 100	Acier galvanisé peint Galvanized steel painted		Boîte / Box 10/100
	FTB250992	x 100	Acier galvanisé peint Galvanized steel painted		LS / Pegboardable 20/120
	FTB250892	x 80	Acier galvanisé peint Galvanized steel painted		LS / Pegboardable 20/120
32 mm	FTB320693	x 1000	Acier galvanisé peint Galvanized steel painted		Boîte / Box 1/25
	FTB320593	x 100	Acier galvanisé peint Galvanized steel painted		Boîte / Box 10/100
50 mm	FTB500192	x 20	Acier galvanisé peint Galvanized steel painted		LS / Pegboardable 20/120

AGRAFER - PERFORER - ASSEMBLER

Staple - Perforate - Assemble

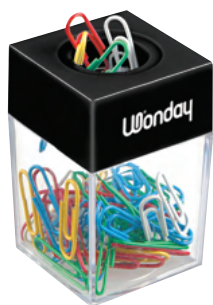

DISTRIBUTEUR MAGNÉTIQUE DE TROMBONES Magnetic paper clips' dispenser

Corps plastique - Plastic body
+ 50 trombones colorés - + 50 colored paper clips

REF.	CARACTÉRISTIQUES SPECIFICATIONS	CONDITIONNEMENT PACKING	UV/PCB
FTB900062	PP-PS	LS / Pegboardable	10/100

DISTRIBUTEUR MAGNÉTIQUE DE TROMBONES Magnetic paper clips' dispenser

Corps plastique - Plastic body
+20 trombones colorés - + 20 colored paper clips

REF.	CARACTÉRISTIQUES SPECIFICATIONS	CONDITIONNEMENT PACKING	UV/PCB
FTB900163	PP-PS	LS / Pegboardable	10/200

RELIEURS D'ARCHIVES / ARCHIVING BINDERS



PLASTIQUE



MÉTALLIQUE

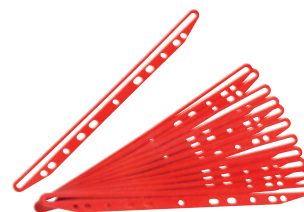

PORTE-REVUE

MODÈLE MODEL	REF.	DIMENSIONS	CAPACITÉ CAPACITY	QUANTITÉ QUANTITY	CARACTÉRISTIQUES SPECIFICATIONS	CONDITIONNEMENT PACKING	UV/PCB
Porte-revue A4 Magazine rack	900471	31 x 20 x 1.5 cm	A4 fermé Closed A4	x 12	PP	Vrac / Bulk	1/180
Métallique / Metal	FFI060073	Entraxe 80 mm 80 mm between two legs	4 cm	x 50	Métal / Metal	Boîte / Box	10/100
Plastique / Plastic	900469	Entraxe 80 mm 80 mm between two legs	7 cm	x 50 + 1 poignée d'insertion en métal / + 1 metal insert handle	PP	Boîte / Box	1/12

Top-print®



MODÈLE MODEL	REF.	DIMENSIONS	CAPACITÉ CAPACITY	QUANTITÉ QUANTITY	CARACTÉRISTIQUES SPECIFICATIONS	CONDITIONNEMENT PACKING	UV/PCB
Plastique «E-Clip»	4010210	Entraxe 80 mm 80 mm between two legs		x 100	PP	Boîte / Box	1/1
	4010410	Entraxe 80 mm 80 mm between two legs		x 100	PP	Boîte / Box	1/1



ATTACHES CROISÉES / BUTTERFLY PAPER CLIPS

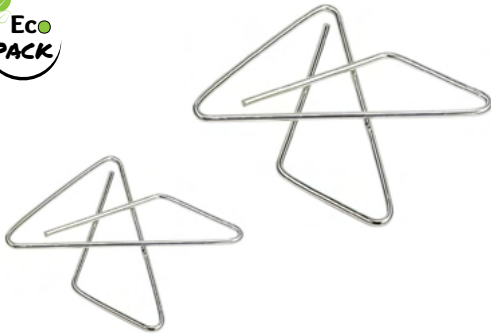

MODÈLE MODEL	REF.	QUANTITÉ QUANTITY	CARACTÉRISTIQUES SPECIFICATIONS	CONDITIONNEMENT PACKING	LIV/PCB	
30 x 40 mm	FFI100073	x 100	Acier nickelé / Nickerled steel		Boîte / Box	1/15
	FFI100272	x 10	Acier nickelé / Nickerled steel		LS / Pegboardable	25/300
47 x 53 mm	FFI100173	x 100	Acier nickelé / Nickerled steel		Boîte / Box	1/10

ANNEAUX BRISÉS / LOOSE-LEAF RINGS

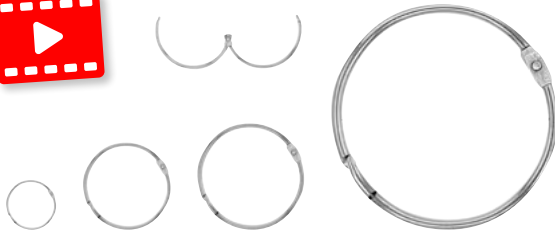

MODÈLE MODEL	REF.	QUANTITÉ QUANTITY	CARACTÉRISTIQUES SPECIFICATIONS	CONDITIONNEMENT PACKING	LIV/PCB	
Ø 64 mm	FFI020672	x 5	Acier nickelé / Nickerled steel		LS / Pegboardable	1/50
Ø 30 mm	FFI020472	x 10	Acier nickelé / Nickerled steel		LS / Pegboardable	1/200
Ø 25 mm	FFI020272	x 10	Acier nickelé / Nickerled steel		LS / Pegboardable	1/300
Ø 14 mm	FFI020072	x 15	Acier nickelé / Nickerled steel		LS / Pegboardable	1/300

PINCES À CLIP / PAPER CLIPPER



PINCE À CLIP Paper clipper

Corps plastique ABS - ABS plastic body
Pour clips 18 mm - For 18 mm metal clips
Clips non inclus - Clips not included

RECHARGE DE CLIPS CHROMÉS 18 MM 18 mm chrome plated clips refill

Pour relier 2 à 50 feuilles - To bind up to 50 sheets

REF.	DIMENSIONS	CARACTÉRISTIQUES SPECIFICATIONS	CONDITIONNEMENT PACKING	LIV/PCB
FPI800162 Pince	141 x 28 x 28 mm	ABS	LS / Pegboardable	10/240
FPI900272 x 50 clips	18 mm	Métal / Metal	Boîte / Box	10/200

AGRAFER - PERFORER - ASSEMBLER

Staple - Perforate - Assemble

PINCES / CLIPS



MINI PINCES À DESSIN COULEUR Mini colour binder clips

MODÈLE MODEL	REF.	QUANTITÉ QUANTITY	CARACTÉRISTIQUES SPECIFICATIONS	CONDITIONNEMENT PACKING	UV/PCB	
19 mm Couleur / Coloured Écartement 6 mm Opening capacity 6 mm	FPI190273	x 40	Métal / Metal		Boîte / Box	1/96
	FPI190372	x 6	Métal / Metal		LS / Pegboardable	20/120



PINCES À DESSIN Binder clips

MODÈLE MODEL	REF.	QUANTITÉ QUANTITY	CARACTÉRISTIQUES SPECIFICATIONS	CONDITIONNEMENT PACKING	UV/PCB	
19 mm Écartement 6 mm Opening capacity 6 mm	FPI190073	x 12	Métal / Metal		Boîte / Box	1/240
	FPI190172	x 12	Métal / Metal		LS / Pegboardable	10/200
25 mm Écartement 8 mm Opening capacity 8 mm	FPI250073	x 12	Métal / Metal		Boîte / Box	1/240
	FPI250172	x 6	Métal / Metal		LS / Pegboardable	10/200
32 mm Écartement 10 mm Opening capacity 10 mm	FPI320073	x 12	Métal / Metal		Boîte / Box	1/144
	FPI320172	x 6	Métal / Metal		LS / Pegboardable	10/200
41 mm Écartement 15 mm Opening capacity 15 mm	FPI410073	x 12	Métal / Metal		Boîte / Box	1/100
	FPI410172	x 3	Métal / Metal		LS / Pegboardable	10/200
51 mm Écartement 20 mm Opening capacity 20 mm	FPI510073	x 12	Métal / Metal		Boîte / Box	1/60
	FPI510172	x 2	Métal / Metal		LS / Pegboardable	10/200



AGRAFER - PERFORER - ASSEMBLER

Staple - Perforate - Assemble



PINCES « SPRING CLIP » « Spring clip » binder clips

MODÈLE MODEL	REF.	QUANTITÉ QUANTITY	CARACTÉRISTIQUES SPECIFICATIONS	CONDITIONNEMENT PACKING	UV/PCB	
100 mm	FPI000073	x 12	Acier nickelé / Nicheled steel		Boîte / Box	1/12
	FPI000172	x 2	Acier nickelé / Nicheled steel		LS / Pegboardable	10/200
144 mm	FPI040073	x 12	Acier nickelé / Nicheled steel		Boîte / Box	1/12
	FPI040172	x 1	Acier nickelé / Nicheled steel		LS / Pegboardable	10/200



PINCES « BULLDOG » « Bulldog » binder clips

MODÈLE MODEL	REF.	QUANTITÉ QUANTITY	CARACTÉRISTIQUES SPECIFICATIONS	CONDITIONNEMENT PACKING	UV/PCB	
20 mm Écartement 10 mm Opening capacity 10 mm	FPI200073	x 12	Acier nickelé / Nicheled steel		Boîte / Box	1/12
	FPI200172	x 12	Acier nickelé / Nicheled steel		LS / Pegboardable	10/200
30 mm Écartement 15 mm Opening capacity 15 mm	FPI300073	x 12	Acier nickelé / Nicheled steel		Boîte / Box	1/12
	FPI300172	x 6	Acier nickelé / Nicheled steel		LS / Pegboardable	10/200
50 mm Écartement 25 mm Opening capacity 25 mm	FPI500073	x 12	Acier nickelé / Nicheled steel		Boîte / Box	1/12
	FPI500172	x 4	Acier nickelé / Nicheled steel		LS / Pegboardable	10/200
60 mm Écartement 35 mm Opening capacity 35 mm	FPI600073	x 12	Acier nickelé / Nicheled steel		Boîte / Box	1/12
	FPI600172	x 2	Acier nickelé / Nicheled steel		LS / Pegboardable	10/200
70 mm Écartement 40 mm Opening capacity 40 mm	FPI700073	x 12	Acier nickelé / Nicheled steel		Boîte / Box	1/12
	FPI700172	x 2	Acier nickelé / Nicheled steel		LS / Pegboardable	10/100



AGRAFER - PERFORER - ASSEMBLER

Staple - Perforate - Assemble

ÉLÉMENTS MAGNÉTIQUES / MAGNETIC ELEMENTS



PINCES AIMANTÉES Magnetic binder clips

MODÈLE MODEL	REF.	QUANTITÉ QUANTITY	FORCE STRENGTH	CARACTÉRISTIQUES SPECIFICATIONS	CONDITIONNEMENT PACKING	LIV/PCB
32 mm	FPI300212	x 3		Acier nickelé / Nickerled steel		LS / Pegboardable 12/144
54 mm	FPI500212*	x 2		Acier nickelé / Nickerled steel		LS / Pegboardable 12/144

* Jusqu'à épuisement des stocks



PINCES AIMANTÉES « CLIPMAG » « Clipmag » magnetic binder clips

MODÈLE MODEL	REF.	QUANTITÉ QUANTITY	FORCE STRENGTH	CARACTÉRISTIQUES SPECIFICATIONS	CONDITIONNEMENT PACKING	LIV/PCB
53 mm	FAI700362	x 1	120 g	Plastique / Plastic TPR		Vrac / Bulk 1/50



CROCHETS DE SUSPENSION MAGNÉTIQUES Magnetic suspension hooks

Crochet dévissable - Screwable hook

MODÈLE MODEL	REF.	QUANTITÉ QUANTITY	FORCE STRENGTH	CARACTÉRISTIQUES SPECIFICATIONS	CONDITIONNEMENT PACKING	LIV/PCB
Ø 25	FAI700472	x 3	4 kg	-		LS / Pegboardable 1/120
Ø 36	FAI700772	x 2	10 kg	-		LS / Pegboardable 1/120
Ø 47	FAI700872	x 2	18 kg	-		LS / Pegboardable 1/120
Ø 47	FAI700672	x 1	18 kg	-		LS / Pegboardable 1/120



FSC000911 Aimants non fournis - Magnets not supplied

FSC000811 + 4 aimants Ø 30 mm - + 4 magnets Ø 30 mm



BANDES D'AFFICHAGE Display strips

Bandes métalliques adhésives - Adhesive metallic strips

REF.	DIM. (HXL CM)	CARACTÉRISTIQUES SPECIFICATIONS	CONDITIONNEMENT PACKING	LIV/PCB
FSC000811	50 x 5	+ 4 aimants + 4 magnets	2 PCS	Vrac / Bulk Lot de 2 / Set of 2 1/36
FSC000911	50 x 3	-	10 PCS	Vrac / Bulk Lot de 10 / Set of 10 1/48

J'ADHÈRE !

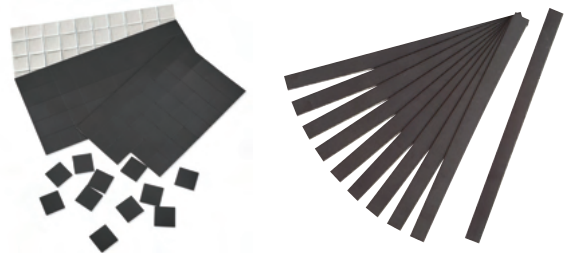

BANDES ET PASTILLES MAGNÉTIQUES ADHÉSIVES Magnetic adhesive tabs and strips

MODÈLE / MODEL	REF.	QUANTITÉ QUANTITY	TAILLE / SIZE	FORCE / TRENGH	CARACTÉRISTIQUES SPECIFICATIONS	CONDITIONNEMENT PACKING	UV/PCB
Bandes / Strips	FAI701111	x 10	300 x 20 x 2 mm	-		Vrac / Bulk	1/30
Pastilles / Tabs	FAI700111	x 168	25 x 20 x 1.1 mm	80 g/cm ²		Vrac / Bulk	1/60
	FAI701711	x 49	14 x 14 x 2 mm	80 g/cm ²		Vrac / Bulk	1/200



PATÈRE MAGNÉTIQUE Magnetic coat hook

Revêtement anti-glisse du côté aimanté - Non-slip covering on magnetic side

REF.	QUANTITÉ QUANTITY	TAILLE SIZE	FORCE STRENGTH	CARACTÉRISTIQUES SPECIFICATIONS	CONDITIONNEMENT PACKING	UV/PCB
FAI800011	x 10	130 x 69 x 62 mm	10 kg		Vrac / Bulk	1/5



DÉVIDOIR ESCARGOT DE BANDE MAGNÉTIQUE ADHÉSIVE Magnetic and adhesive bands snail dispenser

Corps plastique PS - PS plastic body
+ 1 rouleau de bande magnétique 19 mm x 7 m - + 1 magnetic band roll 19 mm x 7 m

REF.	DIMENSIONS	CARACTÉRISTIQUES SPECIFICATIONS	CONDITIONNEMENT PACKING	UV/PCB
FAI700213	19 mm x 7 m	PS	Boîte / Box	1/40

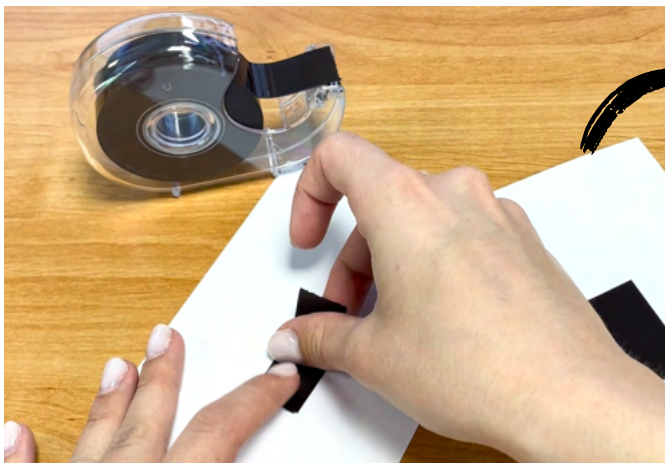

AGRAFER - PERFORER - ASSEMBLER

Staple - Perforate - Assemble

AIMANTS / MAGNETS

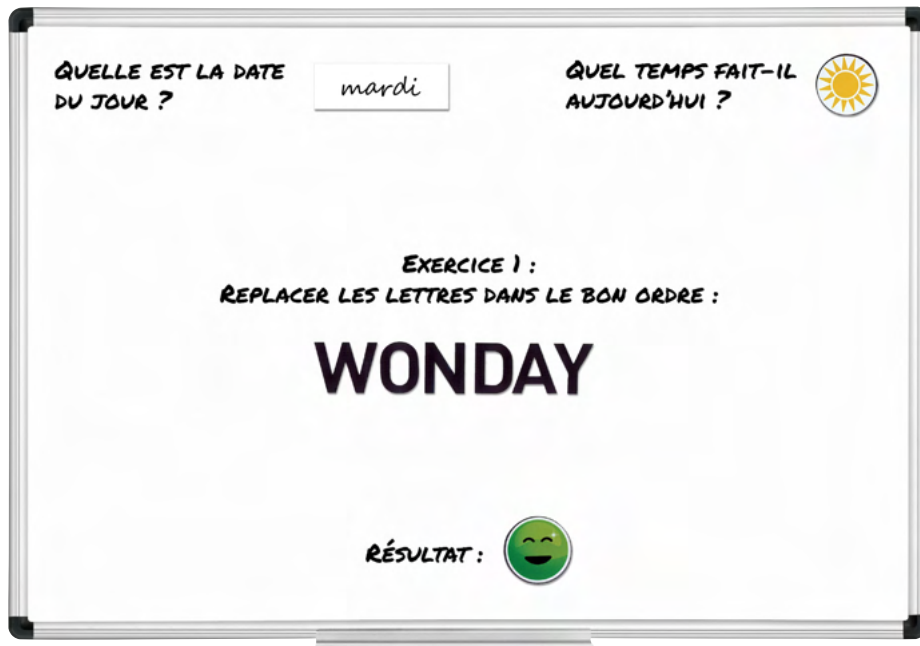

A B C 1 2 3



95 AIMANTS ALPHABET ET CHIFFRES 95 alphabet and numbers magnets

REF.	TAILLE SIZE	QUANTITÉ QUANTITY	CARACTÉRISTIQUES SPECIFICATIONS	CONDITIONNEMENT PACKING	UV/PCB
FAI701411	32 mm	x 95		Vrac / Bulk	1/24



ÉTIQUETTES MAGNÉTIQUES BLANCHES EFFAÇABLES À SEC White magnetic dry erasable labels

REF.	TAILLE SIZE	QUANTITÉ QUANTITY	CARACTÉRISTIQUES SPECIFICATIONS	CONDITIONNEMENT PACKING	UV/PCB
FAI701211	72 x 63.5 mm	x 12		Vrac / Bulk	1/24
FAI701311	99 x 38 mm	x 14		Vrac / Bulk	1/24

6 AIMANTS « MÉTÉO » DOUBLE FACE 6 double-sided « Weather » magnets

REF.	TAILLE SIZE	QUANTITÉ QUANTITY	CARACTÉRISTIQUES SPECIFICATIONS	CONDITIONNEMENT PACKING	UV/PCB
FAI400291	Ø 40 mm	x 6		Vrac / Bulk	1/80



6 AIMANTS « ÉMOTION » DOUBLE FACE 6 double-sided « Emotion » magnets

REF.	TAILLE SIZE	QUANTITÉ QUANTITY	CARACTÉRISTIQUES SPECIFICATIONS	CONDITIONNEMENT PACKING	UV/PCB
FAI400191	Ø 40 mm	x 6		Vrac / Bulk	1/80

COMMENT CHOISIR VOS AIMANTS



• **Aimant néodyme (terre rare) - Neodym magnet (rare earth)**
 Aimant permanent avec une force d'adhérence importante. Résistant à des températures entre -196 °C et 180 °C. Attention fragile. Permanent magnet with a high adhesive strength. Resistant to temperatures between -196°C and 180°C. Caution easily broken.



• **Aimant ferrite - Ferrite magnet**
 Matière brute, peu esthétique donc petit budget. Il peut supporter des températures entre -40 et 250 °C. Utilisable à l'extérieur. Raw material, not very aesthetic, therefore low budget. It can withstand temperatures between -40°C and 250°C. For outdoor use.



• **Aimant isotrope - Isotropic magnet**
 Aimant le plus répandu, de faible puissance, sans direction de magnétisation. Most common magnet, low power, no direction of magnetization.



AIMANTS NÉODYME COULEUR Colour neodym magnets



REF.	QUANTITÉ QUANTITY	TAILLE SIZE	FORCE STRENGTH	CARACTÉRISTIQUES SPECIFICATIONS	CONDITIONNEMENT PACKING	UV/PCB
FAI060092	x 12	Ø 6 x 10 mm	15 feuilles 15 sheets		LS / Pegboardable	1/264

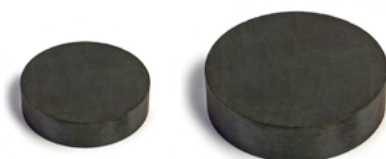

AIMANTS FERRITE Ferrite magnets



REF.	QUANTITÉ QUANTITY	TAILLE SIZE	FORCE STRENGTH	CARACTÉRISTIQUES SPECIFICATIONS	CONDITIONNEMENT PACKING	UV/PCB
FAI140171	x 10	Ø 14 x 6 mm	6 feuilles / 6 sheets		Vrac / Bulk	130/390
FAI701071	x 20	Ø 10 x 6 mm	-		Vrac / Bulk	20/500

AGRAFER - PERFORER - ASSEMBLER

Staple - Perforate - Assemble



AIMANTS RONDS
Round magnets



MODÈLE MODEL	REF.	QUANTITÉ QUANTITY	FORCE STRENGTH	CARACTÉRISTIQUES SPECIFICATIONS	CONDITIONNEMENT PACKING	LIV/PCB
Ø 10 mm	FAI100791	x 20	4 feuilles / 4 sheets		Vrac / Bulk	10/100
	FAI100092	x 10	4 feuilles / 4 sheets		LS / Pegboardable	10/100
	FAI100102	x 10	4 feuilles / 4 sheets		LS / Pegboardable	10/100
	FAI100302	x 10	4 feuilles / 4 sheets		LS / Pegboardable	10/100
	FAI100402	x 10	4 feuilles / 4 sheets		LS / Pegboardable	10/100
Ø 15 mm	FAI150691	x 60	4 feuilles / 4 sheets		Vrac / Bulk	1/100
	FAI150092	x 10	4 feuilles / 4 sheets		LS / Pegboardable	10/100
	FAI150102	x 10	4 feuilles / 4 sheets		LS / Pegboardable	10/100
	FAI150202	x 10	4 feuilles / 4 sheets		LS / Pegboardable	10/100
	FAI150302	x 10	4 feuilles / 4 sheets		LS / Pegboardable	10/100
	FAI150502	x 10	4 feuilles / 4 sheets		LS / Pegboardable	10/100
Ø 20 mm	FAI200691	x 10	10 feuilles / 10 sheets		Vrac / Bulk	10/100
	FAI200891	x 6	10 feuilles / 10 sheets		Vrac / Bulk	10/100
	FAI200092	x 6	10 feuilles / 10 sheets		LS / Pegboardable	10/100
	FAI200102	x 6	10 feuilles / 10 sheets		LS / Pegboardable	10/100
	FAI200202	x 6	10 feuilles / 10 sheets		LS / Pegboardable	10/100
	FAI200302	x 6	10 feuilles / 10 sheets		LS / Pegboardable	10/100
	FAI200502	x 6	10 feuilles / 10 sheets		LS / Pegboardable	10/100
Ø 25 mm	FAI250691	x 6	13 feuilles / 13 sheets		Vrac / Bulk	10/300
	FAI250092	x 5	13 feuilles / 13 sheets		LS / Pegboardable	10/100
	FAI250102	x 5	13 feuilles / 13 sheets		LS / Pegboardable	10/100
	FAI250202	x 5	13 feuilles / 13 sheets		LS / Pegboardable	10/100
	FAI250302	x 5	13 feuilles / 13 sheets		LS / Pegboardable	10/100
	FAI250402	x 5	13 feuilles / 13 sheets		LS / Pegboardable	10/100
	FAI250502	x 5	13 feuilles / 13 sheets		LS / Pegboardable	10/100

AGRAFER - PERFORER - ASSEMBLER

Staple - Perforate - Assemble



AIMANTS RONDS Round magnets



Ø 30



Ø 32



Ø 40

MODÈLE MODEL	REF.	QUANTITÉ QUANTITY	FORCE STRENGTH	CARACTÉRISTIQUES SPECIFICATIONS	CONDITIONNEMENT PACKING	UV/PCB
Ø 30 mm	FAI300691	x 10	14 feuilles / 14 sheets		Vrac / Bulk	10/150
	FAI300092	x 4	14 feuilles / 14 sheets		LS / Pegboardable	10/100
	FAI300102	x 4	14 feuilles / 14 sheets		LS / Pegboardable	10/100
	FAI300202	x 4	14 feuilles / 14 sheets		LS / Pegboardable	10/100
	FAI300302	x 4	14 feuilles / 14 sheets		LS / Pegboardable	10/100
	FAI300502	x 4	14 feuilles / 14 sheets		LS / Pegboardable	10/100
	Ø 32 mm	FAI320092	x 4	14 feuilles / 14 sheets		LS / Pegboardable
FAI320102		x 4	14 feuilles / 14 sheets		LS / Pegboardable	10/100
FAI320202		x 4	14 feuilles / 14 sheets		LS / Pegboardable	10/100
FAI320302		x 4	14 feuilles / 14 sheets		LS / Pegboardable	10/100
FAI320402		x 4	14 feuilles / 14 sheets		LS / Pegboardable	10/100
Ø 40 mm	FAI400491	x 4	20 feuilles / 20 sheets		Vrac / Bulk	10/100
	FAI400092	x 2	20 feuilles / 20 sheets		LS / Pegboardable	10/100
	FAI400302*	x 2	20 feuilles / 20 sheets		LS / Pegboardable	10/100
	FAI400502*	x 2	20 feuilles / 20 sheets		LS / Pegboardable	10/100

* Jusqu'à épuisement des stocks



**ENTRE 2024 ET 2025
CHANGEMENT DE PACKAGING
BETWEEN 2024 AD 2025,
CHANGE OF PACKAGING**

AGRAFER - PERFORER - ASSEMBLER

Staple - Perforate - Assemble



AIMANTS RECTANGULAIRES À TÉTON

Rectangular magnets with button



REF.	QUANTITÉ QUANTITY	TAILLE SIZE	FORCE STRENGTH	CARACTÉRISTIQUES SPECIFICATIONS	CONDITIONNEMENT PACKING	LIV/PCB
FAI510002	x 2	50 x 23 mm	20 feuilles / 20 sheets		LS / Pegboardable	10/100
FAI510102	x 2	50 x 23 mm	20 feuilles / 20 sheets		LS / Pegboardable	10/100



AIMANTS RECTANGULAIRES À TÉTON

Rectangular magnets with button



REF.	QUANTITÉ QUANTITY	TAILLE SIZE	FORCE STRENGTH	CARACTÉRISTIQUES SPECIFICATIONS	CONDITIONNEMENT PACKING	LIV/PCB
FAI510402	x 5	27 x 14 mm	12 feuilles / 12 sheets		LS / Pegboardable	10/100
FAI510602	x 5	27 x 14 mm	12 feuilles / 12 sheets		LS / Pegboardable	10/100

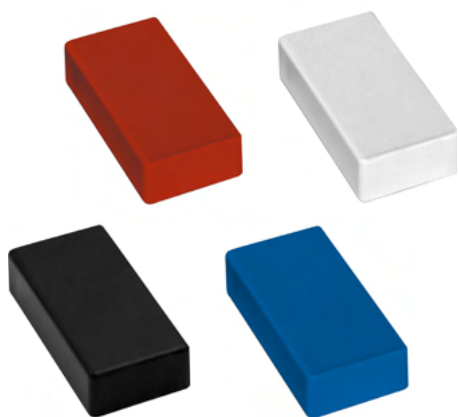

AIMANTS RECTANGULAIRES

Rectangular magnets



REF.	QUANTITÉ QUANTITY	TAILLE SIZE	FORCE STRENGTH	CARACTÉRISTIQUES SPECIFICATIONS	CONDITIONNEMENT PACKING	LIV/PCB
FAI500002	x 6	25 x 12 mm	10 feuilles / 10 sheets		LS / Pegboardable	10/100
FAI500102	x 6	25 x 12 mm	10 feuilles / 10 sheets		LS / Pegboardable	10/100
FAI500202*	x 6	25 x 12 mm	10 feuilles / 10 sheets		LS / Pegboardable	10/100
FAI500302	x 6	25 x 12 mm	10 feuilles / 10 sheets		LS / Pegboardable	10/100

* Jusqu'à épuisement des stocks

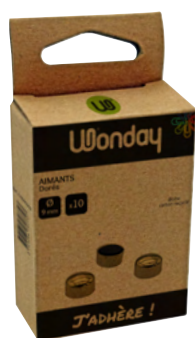

AIMANTS MÉTALLISÉS

Metallic magnets



REF.	QUANTITÉ QUANTITY	TAILLE SIZE	FORCE STRENGTH	CARACTÉRISTIQUES SPECIFICATIONS	CONDITIONNEMENT PACKING	LIV/PCB
FAI090202	x 12	Ø 9 mm	4 feuilles / 4 sheets		LS / Pegboardable	20/120
FAI090102	x 12	Ø 9 mm	4 feuilles / 4 sheets		LS / Pegboardable	20/120

COLLES / GLUES



Tube en R-PP



BÂTONS DE COLLE D'ORIGINE VÉGÉTALE* Vegetal glue sticks

Tube plastique PE/R-PP - PE/R-PP plastic tube

Colle blanche à base d'eau et d'amidon de pomme de terre - White glue made of water and potato starch

*Ce produit n'est pas un aliment et ne doit pas être ingéré. Éviter le contact avec les yeux. Pour les enfants, à utiliser en présence d'adultes. This product is not food and should not be ingested. Avoid contact with eyes. For children, use in the supervision of an adult.

REF.	TAILLE SIZE	CARACTÉRISTIQUES SPECIFICATIONS	CONDITIONNEMENT PACKING	LIV/PCB
FCL400113	40 g	61% R-PP	Boîte / Box	12/144
FCL200113	20 g	61% R-PP	Boîte / Box	12/288
FCL100113	10 g	56% R-PP	Boîte / Box	24/576



ON A LA PATATE !



ROLLER DE COLLE PERMANENTE Permanent glue tape

Bande de colle transparente - Transparent glue strip

Corps plastique PS/POM - PS/POM plastic body

Capot de protection - Protective cover

REF.	TAILLE/SIZE	CARACTÉRISTIQUES SPECIFICATIONS	CONDITIONNEMENT PACKING	LIV/PCB
FCL720012	8 mm x 7 m		LS / Pegboardable	12/144



ROLLER DE COLLE REPOSITIONNABLE Removable glue tape

Bande de colle transparente - Transparent glue strip

Corps plastique PS/POM - PS/POM plastic body

Capot de protection - Protective cover

REF.	TAILLE/SIZE	CARACTÉRISTIQUES SPECIFICATIONS	CONDITIONNEMENT PACKING	LIV/PCB
FCL720112	8 mm x 7 m		LS / Pegboardable	12/144



COLLER - CORRIGER - ENSEIGNER

Stick - Correct - Teach

CORRECTEURS / WHITE CORRECTIONS



Tête en R-POM
Corps en R-PS



RUBAN CORRECTEUR LATÉRAL DROITIER/GAUCHER Sideway correction tape right/left

Largeur de 5 mm - Width 5 mm
Tête pivotante 180° droitier/gaucher - Right/left swivel head 180°
Corps plastique R-POM/R-PS/POM - R-POM/R-PS/POM plastic body

REF.	TAILLE/SIZE	CARACTÉRISTIQUES SPECIFICATIONS	CONDITIONNEMENT PACKING	LIV/PCB
FCR120002	5 mm x 12 m		Vrac / Bulk	12/144



RUBAN CORRECTEUR FRONTAL Front correction tape

Largeur de 5 mm - Width 5 mm
Corps plastique PS/POM - PS/POM plastic body

REF.	TAILLE/SIZE	CARACTÉRISTIQUES SPECIFICATIONS	CONDITIONNEMENT PACKING	LIV/PCB
FCR080102	5 mm x 8 m		LS / Pegboardable	12/144

CORRECTEUR LIQUIDE BLANC White correction fluid

À base d'eau - Water-based
Flacon de 20 ml - 20 ml bottle
Pinceau applicateur - Application brush



REF.	TAILLE/SIZE	CARACTÉRISTIQUES SPECIFICATIONS	CONDITIONNEMENT PACKING	LIV/PCB
FCR200021*	20 ml		Vrac / Bulk	10/500

* Jusqu'à épuisement des stocks



RUBAN CORRECTEUR LATÉRAL Sideway correction tape

Largeur de 5 mm - Width 5 mm
Corps plastique PS/POM - PS/POM plastic body

REF.	TAILLE/SIZE	CARACTÉRISTIQUES SPECIFICATIONS	CONDITIONNEMENT PACKING	LIV/PCB
FCR080002	5 mm x 8 m		LS / Pegboardable	12/144



3 MINI RUBANS CORRECTEURS BLANCS 3 white mini correction tapes

Correcteurs frontaux - Front correction tapes
Largeur de 5 mm - Width 5 mm
Corps plastique PS/POM - PS/POM plastic body

REF.	TAILLE/SIZE	CARACTÉRISTIQUES SPECIFICATIONS	CONDITIONNEMENT PACKING	LIV/PCB
FCR040092	5 mm x 4 m		LS / Pegboardable	12/192



EFFACEUR-RÉÉCRIVEUR Ink eradicator pen



Effaceur pointe ogive - Bullet tip ink eradicator
Réécrivain pointe fine, encre bleue - Fine tip rewriter, blue ink

REF.	QUANTITÉ QUANTITY	CARACTÉRISTIQUES SPECIFICATIONS	CONDITIONNEMENT PACKING	LIV/PCB
FEC310062	x 6		LS / Pegboardable	12/96

GOMMES / ERASERS



GOMME BLANCHE SANS PVC White pvc-free eraser

Efface le crayon à papier et la mine graphite - Erase pencil and graphite lead
Gomme souple protégée par un fourreau papier - Soft eraser protected by a paper sleeve

REF.	TAILLE/SIZE	CARACTÉRISTIQUES SPECIFICATIONS	CONDITIONNEMENT PACKING	LIV/PCB
FCR300063	60 x 21 x 11 mm x 20		Boîte / Box	20/400



MINI GOMME BLANCHE SANS PVC Mini white pvc-free eraser

Efface le crayon à papier et la mine graphite - Erase pencil and graphite lead
Gomme souple protégée par un fourreau papier - Soft eraser protected by a paper sleeve

REF.	TAILLE/SIZE	CARACTÉRISTIQUES SPECIFICATIONS	CONDITIONNEMENT PACKING	LIV/PCB
FCR300263	39 x 18 x 12 mm x 36		Boîte / Box	36/720



GOMME BLANCHE SANS PVC « OUALYNE » « Oualyne » white pvc-free eraser

Efface le crayon à papier et la mine graphite - Erase pencil and graphite lead

REF.	TAILLE/SIZE	CARACTÉRISTIQUES SPECIFICATIONS	CONDITIONNEMENT PACKING	LIV/PCB
FCR350163	60 x 28 x 10 mm x 20		Boîte / Box	20/400
FCR350062	60 x 28 x 10 mm		LS / Pegboardable	20/320



GOMME BLANCHE SANS PVC « RECTANGO » « Rectango » white pvc-free eraser

Efface le crayon à papier et la mine graphite - Erase pencil and graphite lead

REF.	TAILLE/SIZE	CARACTÉRISTIQUES SPECIFICATIONS	CONDITIONNEMENT PACKING	LIV/PCB
FCR350461	33 x 23 x 8 mm x 40		Boîte / Box	40/800



GOMME « MIE DE PAIN » Kneadable eraser

Pâte modelable - Kneadable pliable paste
Pour estomper et effacer le fusain, la sanguine, le crayon graphite, le pastel...
To blur or erase charcoal, sanguine, graphite pencil, pastel,...

REF.	TAILLE/SIZE	CARACTÉRISTIQUES SPECIFICATIONS	CONDITIONNEMENT PACKING	LIV/PCB
FCR600063	38 x 34 x 10 mm x 18		Boîte / Box	18/432

COLLER - CORRIGER - ENSEIGNER

Stick - Correct - Teach

PANNEAUX COLLECTIFS / COLLECTIVE PANELS

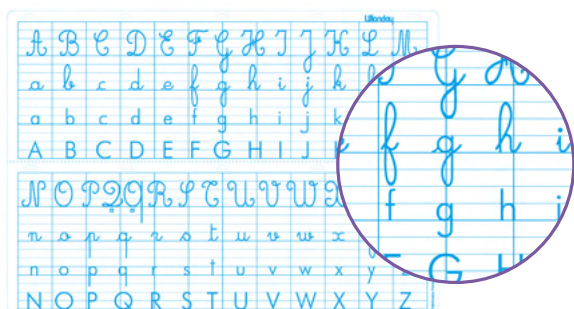

PANNEAU COLLECTIF : ABÉCÉDAIRE

Collective panel : alphabet primer



Revêtement effaçable à sec et à l'eau - Dry and water erasable
Trous européens - European holes
Coins arrondis - Rounded corners

REF.	DIMENSIONS	CARACTÉRISTIQUES SPECIFICATIONS	CONDITIONNEMENT PACKING	UV/PCB
FOP100261*	70 x 100 cm	PP 	Vrac / Bulk	1/-

* Jusqu'à épuisement des stocks

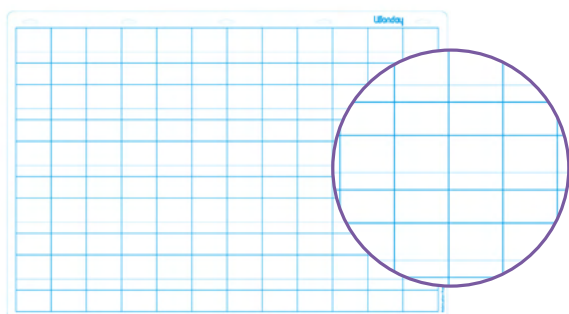

PANNEAU COLLECTIF : DOUBLE LIGNES

Collective panel : Double lines



Revêtement effaçable à sec et à l'eau - Dry and water erasable
Trous européens - European holes
Coins arrondis - Rounded corners

REF.	DIMENSIONS	CARACTÉRISTIQUES SPECIFICATIONS	CONDITIONNEMENT PACKING	UV/PCB
FOP100361*	70 x 100 cm	PP 	Vrac / Bulk	1/-

* Jusqu'à épuisement des stocks

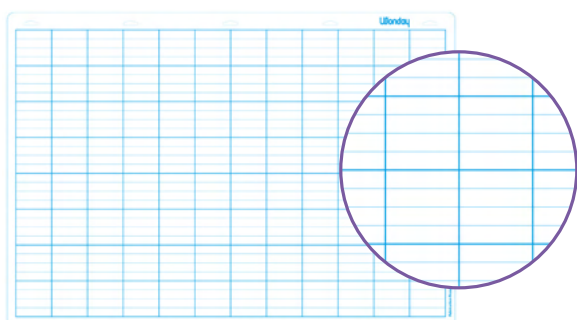

PANNEAU COLLECTIF : « SÉYÈS® » SIMPLE

Collective panel : Simple « Séyès® »



Revêtement effaçable à sec et à l'eau - Dry and water erasable
Trous européens - European holes
Coins arrondis - Rounded corners

REF.	DIMENSIONS	CARACTÉRISTIQUES SPECIFICATIONS	CONDITIONNEMENT PACKING	UV/PCB
FOP100461*	70 x 100 cm	PP 	Vrac / Bulk	1/-

* Jusqu'à épuisement des stocks

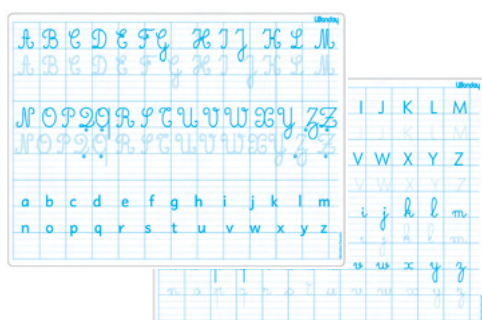

EDUC'ARDOISE 2 FACES : ALPHABÉTIQUE

2 sides board : Alphabet primer



En polypropylène - Polypropylene
Revêtement effaçable à sec et à l'eau - Dry and water erasable
Traitement Velleda® recto-verso - Velleda® double-sided treatment
Coins arrondis - Rounded corners

REF.	DIMENSIONS	CARACTÉRISTIQUES SPECIFICATIONS	CONDITIONNEMENT PACKING	UV/PCB
FOP100761*	24 x 32 cm	PP 	Vrac / Bulk	10/200

* Jusqu'à épuisement des stocks

ARDOISES / SLATES

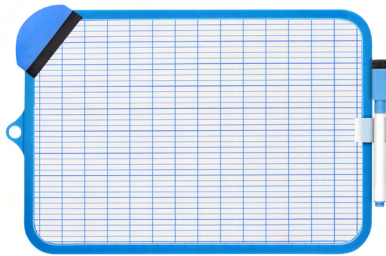

KIT ARDOISE « SÉYÈS® » 3 PIÈCES « Séyès® » slate kit 3 pieces

2 faces : 1 quadrillage « Séyès® », 1 blanche - 2 sides : 1 « Séyès® » ruling, 1 plain white
Ardoise cartonnée, cadre plastique PP - Cardboard slate, plastic PP frame
Trou de suspension - Hanging hole
+ 1 mini brosse - 1 mini felt eraser
+ 1 marqueur bleu effaçable à sec - 1 blue marker dry erasable

REF.	DIMENSIONS	CARACTÉRISTIQUES SPECIFICATIONS	CONDITIONNEMENT PACKING	LIV/PCB
FAR400162	260 x 185 mm		LS / Pegboardable	20/80

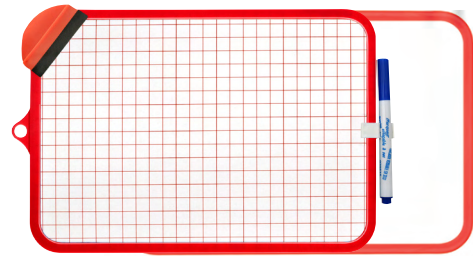

KIT ARDOISE QUADRILLÉE 3 PIÈCES Grid slate kit 3 pieces

2 faces : 1 quadrillée, 1 blanche - 2 sides : 1 grid, 1 plain white
Ardoise cartonnée, cadre plastique PP - Cardboard slate, plastic PP frame
Trou de suspension - Hanging hole
+ 1 mini brosse - 1 mini felt eraser
+ 1 marqueur bleu effaçable à sec - 1 blue marker dry erasable

REF.	DIMENSIONS	CARACTÉRISTIQUES SPECIFICATIONS	CONDITIONNEMENT PACKING	LIV/PCB
FAR300162	260 x 185 mm		LS / Pegboardable	20/80

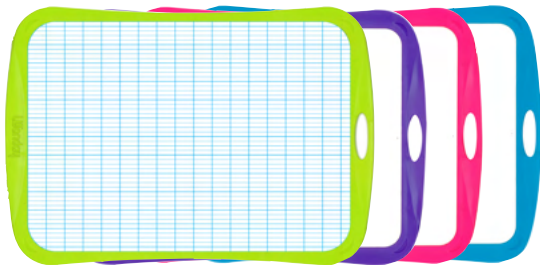

ARDOISE « SÉYÈS® » « Séyès® » writing slate

2 faces : 1 quadrillage « Séyès® », 1 blanche - 2 sides : 1 « Séyès® » ruling, 1 plain white
Ardoise cartonnée, cadre plastique TPE injecté - Cardboard slate, injected plastic TPE frame
Trou de suspension - Hanging hole

REF.	DIMENSIONS	CARACTÉRISTIQUES SPECIFICATIONS	CONDITIONNEMENT PACKING	LIV/PCB
FAR400461	283 x 200 mm		Vrac / Bulk	4/96

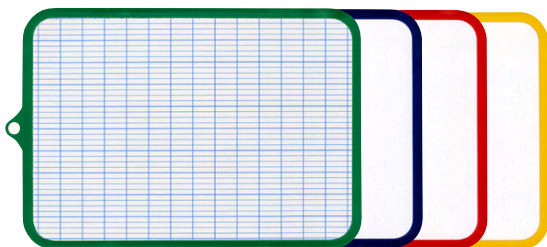

ARDOISE « SÉYÈS® » « Séyès® » writing slate

2 faces : 1 quadrillage « Séyès® », 1 blanche - 2 sides : 1 « Séyès® » ruling, 1 plain white
Ardoise cartonnée, cadre plastique PP - Cardboard slate, plastic PP frame
Trou de suspension - Hanging hole

REF.	DIMENSIONS	CARACTÉRISTIQUES SPECIFICATIONS	CONDITIONNEMENT PACKING	LIV/PCB
FAR400361	260 x 185 mm		Vrac / Bulk	12/120

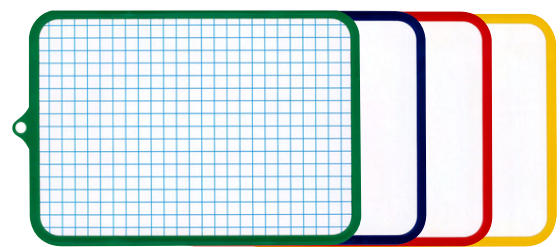

ARDOISE QUADRILLÉE Cross-ruled writing board

2 faces : 1 quadrillée, 1 blanche - 2 sides : 1 grid, 1 plain white
Ardoise cartonnée, cadre plastique PP injecté - Cardboard slate, injected plastic PP frame
Trou de suspension - Hanging hole

REF.	DIMENSIONS	CARACTÉRISTIQUES SPECIFICATIONS	CONDITIONNEMENT PACKING	LIV/PCB
FAR300261	260 x 185 mm		Vrac / Bulk	12/120

COLLER - CORRIGER - ENSEIGNER

Stick - Correct - Teach



ARDOISE MÉTAL DOUBLE FACE Double side metal writing slate

2 faces : 1 blanche, 1 noire - 2 sides : 1 white, 1 black
Ardoise métallique, cadre plastique - Metallic slate, plastic frame
+ 1 mini brosse aimantée - 1 mini magnetic felt eraser

REF.	DIMENSIONS	CARACTÉRISTIQUES SPECIFICATIONS	CONDITIONNEMENT PACKING	LIV/PCB
FAR500171	300 x 270 mm		Vrac / Bulk x4	3/9



ARDOISE MÉTAL Metal writing slate

1 face blanche - 1 white side
Ardoise métallique aimanté, cadre plastique - Metallic slate magnetic, plastic frame
+ 1 mini brosse aimantée - 1 mini magnetic felt eraser

REF.	DIMENSIONS	CARACTÉRISTIQUES SPECIFICATIONS	CONDITIONNEMENT PACKING	LIV/PCB
FAR500071	300 x 200 mm		Vrac / Bulk	12/72

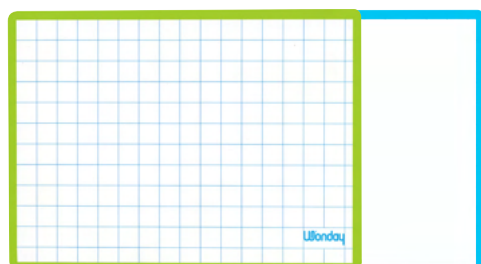

ARDOISE QUADRILLÉE Grid slate

2 faces : 1 quadrillée, 1 blanche - 2 sides : 1 grid, 1 plain white
Ardoise cartonnée, cadre imprimé, bords arrondis - Cardboard slate, printed frame, rounded edges

REF.	DIMENSIONS	CARACTÉRISTIQUES SPECIFICATIONS	CONDITIONNEMENT PACKING	LIV/PCB
FAR300341	260 x 190 mm		Vrac / Bulk	48/144

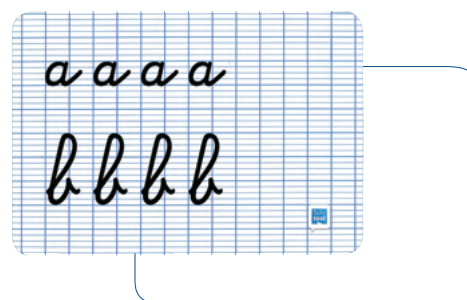

ARDOISE « SÉYÈS® » « Séyès® » writing slate

2 faces : 1 quadrillage « Séyès® », 1 blanche - 2 sides : 1 « Séyès® » ruling, 1 plain white
Ardoise cartonnée, sans cadre, bords arrondis - Frameless cardboard slate, rounded edges

REF.	DIMENSIONS	CARACTÉRISTIQUES SPECIFICATIONS	CONDITIONNEMENT PACKING	LIV/PCB
FAR000341	250 x 176 mm		Vrac / Bulk	50/150

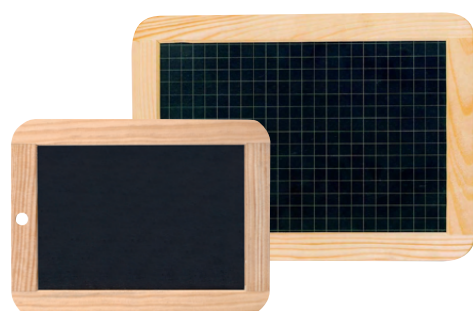

ARDOISE NATURELLE Natural slate



2 faces : 1 unie, 1 quadrillée blanc - 2 sides : 1 plain, 1 white cross-ruling
Cadre bois - Wooden frame
Trou de suspension - Hanging hole

REF.	DIMENSIONS	CARACTÉRISTIQUES SPECIFICATIONS	CONDITIONNEMENT PACKING	LIV/PCB
FAR100041	260 x 180 mm		Vrac / Bulk	1/25
FAR100141	190 x 145 mm		Vrac / Bulk	1/25

COLLER - CORRIGER - ENSEIGNER

Stick - Correct - Teach



ARDOISE NOIRE Black slate



2 faces ardoisine noires unies - 2 black plain sides
Cadre bois - Wooden frame
Trou de suspension - Hanging hole

REF.	DIMENSIONS	CARACTÉRISTIQUES SPECIFICATIONS	CONDITIONNEMENT PACKING	LIV/PCB
FAR100441	600 x 400 mm		Vrac / Bulk	2/26
FAR100341	450 x 300 mm		Vrac / Bulk	5/30
FAR100241	340 x 260 mm		Vrac / Bulk	25/25



ARDOISE NOIRE Black slate



2 faces ardoisine noires unies - 2 black plain sides
Sans cadre - No frame
Cordon de suspension - Hanging cord
+ 2 craies blanches incluses - 2 white chalks included

REF.	DIMENSIONS	CARACTÉRISTIQUES SPECIFICATIONS	CONDITIONNEMENT PACKING	LIV/PCB
FAR000041	250 x 200 mm		Vrac / Bulk	1/25

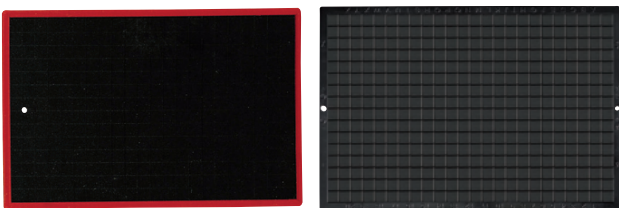

ARDOISE PLASTIQUE Plastic slate

2 faces : 1 quadrillée noire, 1 noire - 2 sides : 1 black grid, 1 plain black
FAR000161 sans cadre - FAR000161 no frame
FAR200061 cadre peint - FAR000161 painted frame
Trou de suspension - Hanging hole

REF.	DIMENSIONS	CARACTÉRISTIQUES SPECIFICATIONS	CONDITIONNEMENT PACKING	LIV/PCB
FAR200061	240 x 160 mm		Vrac / Bulk	25/150
FAR000161	240 x 160 mm		Vrac / Bulk	25/150

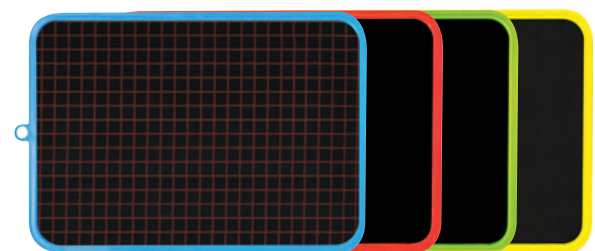

ARDOISE CARTONNÉE Cardboard slate

2 faces : 1 quadrillée rouge, 1 noire - 2 sides : 1 red grid, 1 plain black
Ardoise cartonnée, cadre plastique PP - Cardboard slate, plastic PP frame
Trou de suspension - Hanging hole

REF.	DIMENSIONS	CARACTÉRISTIQUES SPECIFICATIONS	CONDITIONNEMENT PACKING	LIV/PCB
FAR200441	260 x 190 mm		Vrac / Bulk	12/120

COLLER - CORRIGER - ENSEIGNER

Stick - Correct - Teach

ACCESSOIRES D'ARDOISE / ACCESSORIES FOR WRITING BOARDS



CRAIES ANTI-POUSSIÈRE Dustless chalks

Écriture longue durée - Longlasting writing
Effaçage aisé - Easy erasing
Écriture souple - Smooth writing



REF.	QUANTITÉ QUANTITY	CARACTÉRISTIQUES SPECIFICATIONS	CONDITIONNEMENT PACKING	LIV/PCB
FEC650203	x 100		Boîte / Box	1/16
FEC650393	x 100		Boîte / Box	1/16
FEC650002	x 10		LS / Pegboardable	10/120
FEC650192	x 10		LS / Pegboardable	10/120



CRAYONS BLANCS White pencils

Pour ardoises naturelles et ardoisines - For natural and black slates

REF.	CARACTÉRISTIQUES SPECIFICATIONS	CONDITIONNEMENT PACKING	LIV/PCB
FEC150242	x3	LS / Pegboardable	1/24

PORTE-CRAIE MAGNÉTIQUE Magnetic chalk holder

REF.	DIM.	CARACTÉRISTIQUES SPECIFICATIONS	CONDITIONNEMENT PACKING	LIV/PCB
FEC900061	Ø 10 mm	PP	Vrac / Bulk	1/500



**MARQUEURS
CRAIE LIQUIDE
DISPONIBLES
PAGE 158**





FAR090192



BOÎTIER ÉPONGE SCOLAIRE

Sponge in individual box

Éponge végétale cellulosique - Vegetable sponge

Pour ardoises noires et naturelles - For black and natural slates

Qualité supérieure - High quality erasing

REF.	DIMENSIONS	CARACTÉRISTIQUES SPECIFICATIONS	CONDITIONNEMENT PACKING	LIV/PCB
FAR090192	Ø 65mm		LS / Pegboardable	10/120
FAR900091	Ø 65 mm		Vrac / Bulk	10/360



MINI-BROSSE

Mini-brush

Pour ardoises noires et naturelles - For black and natural slates

Poignée bois brut, base feutre noir - Raw wooden handle, black felt base

REF.	DIMENSIONS	CARACTÉRISTIQUES SPECIFICATIONS	CONDITIONNEMENT PACKING	LIV/PCB
FAR900442	70 x 28 x 35 mm		LS / Pegboardable	10/200

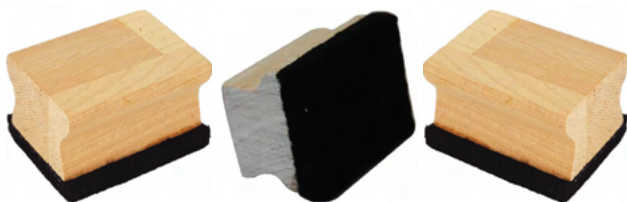

MINI-BROSSSES

Mini-brushes

Pour ardoises noires et naturelles - For black and natural slates

Poignée bois brut, base feutre noir - Raw wooden handle, black felt base

REF.	DIMENSIONS	CARACTÉRISTIQUES SPECIFICATIONS	CONDITIONNEMENT PACKING	LIV/PCB
FAR900841	50 x 35 x 40 mm	x 3	Vrac / Bulk	1/80

BOÎTIER ÉPONGE SCOLAIRE

Sponge in individual box

Éponge synthétique PU blanche - White synthetic PU sponge

Pour ardoises noires et naturelles - For black and natural slates

REF.	DIMENSIONS	CARACTÉRISTIQUES SPECIFICATIONS	CONDITIONNEMENT PACKING	LIV/PCB
FAR900291	Ø 65 mm		Vrac / Bulk	10/360
FAR900392	Ø 65 mm		LS / Pegboardable	30/600



MINI-BROSSE

Mini-brush

Pour ardoises blanches - For white writing slates

Poignée bois brut, base synthétique blanche - Raw wooden handle, white synthetic base

REF.	DIMENSIONS	CARACTÉRISTIQUES SPECIFICATIONS	CONDITIONNEMENT PACKING	LIV/PCB
FAR900542	70 x 35 x 30 mm		LS / Pegboardable	10/200



CHIFFONNETTE MICROFIBRE

Microfiber cloth

Pour tous les supports - For all surfaces

REF.	DIMENSIONS	CARACTÉRISTIQUES SPECIFICATIONS	CONDITIONNEMENT PACKING	LIV/PCB
FAR900722	200 x 200 mm		LS / Pegboardable	20/200

TRACER - MESURER

Trace - Measure

COMPAS / COMPASSES



COMPAS CANON « MON PREMIER COMPAS » « My first compass » canon compass

Corps plastique - Plastic body
Coloris assortis - Assorted colours
Guide à crémaillère - Rack guide
Bague d'adaptation, vis de réglage - Universal holder, tightening screw
+ 1 crayon - 1 pencil

REF.	DIMENSIONS	CARACTÉRISTIQUES SPECIFICATIONS	CONDITIONNEMENT PACKING	LIV/PCB
FCO100162	135 mm	ABS/PS	LS / Pegboardable	25/250
FCO100961	135 mm	ABS/PS	Vrac / Bulk	12/480

COMPAS CANON Canon compass

Corps plastique - Plastic body
Guide à crémaillère - Rack guide
Vis de réglage - Tightening screw
Pointe sécurité - Safety point
+ 1 crayon - 1 pencil

REF.	DIMENSIONS	CARACTÉRISTIQUES SPECIFICATIONS	CONDITIONNEMENT PACKING	LIV/PCB
FCO100562	139 mm	ABS/PS	LS / Pegboardable	25/250



COMPAS CANON « COLOR POP » « Color Pop » canon compasses

Corps plastique - Plastic body
Guide à crémaillère - Rack guide
Vis de réglage - Tightening screw
+ 1 crayon - 1 pencil

REF.	QUANTITÉ QUANTITY	CARACTÉRISTIQUES SPECIFICATIONS	CONDITIONNEMENT PACKING	LIV/PCB
FCO101561	x 12	ABS	Vrac / Bulk	1/24



COMPAS CANON « ECO » « Eco » canon compass

Corps métal, tête plastique - Metal body, plastic head
Guide à crémaillère - Rack guide
Vis de réglage - Tightening screw
+ 1 crayon - 1 pencil

REF.	DIMENSIONS	CARACTÉRISTIQUES SPECIFICATIONS	CONDITIONNEMENT PACKING	LIV/PCB
FCO100872	120 mm	ABS / ABS Métal / Metal	LS / Pegboardable	12/288
FCO101161	120 mm	ABS / ABS Métal / Metal	Vrac / Bulk	50/600

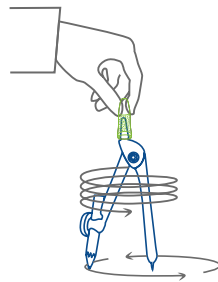

Cercles faciles
Easy circles

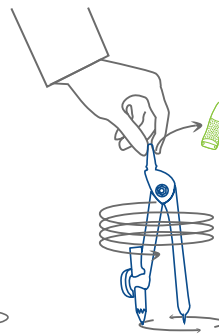

Mini cercles
Mini circles



COMPAS CANON « TWIST'N SAFE » « Twist'n safe » canon compass

Corps métal, embout PS - Metal body, PS tip
Guide à crémaillère - Rack guide
Bague d'adaptation, vis de réglage - Universal holder, tightening screw
Capuchon 2 en 1 : protection pointe + embout twister amovible antigrip - 2 in 1 cap : protective tip, removable anti-grip twister tip
Compas + 1 crayon dans un étui - Compass + 1 pencil in a pouch
Brevet japonais - Japan patent

REF.	DIMENSIONS	CARACTÉRISTIQUES SPECIFICATIONS	CONDITIONNEMENT PACKING	LIV/PCB
FCO101202	145 mm	PS / PS Métal / Metal	LS / Pegboardable	10/240

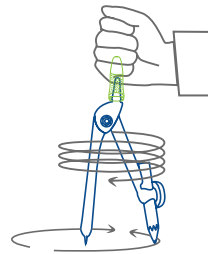

Adapté à la main de l'enfant
Designed for child's hands



COMPAS CANON ET MINE « 360° STAR » « 360° Star » canon and lead compasses

Corps plastique - Plastic body
Guide à crémaillère - Rack guide
FCO101062 & FCO100761 :
- Vis de réglage - Tightening screw
- Crayon non inclus - Pencil not included

REF.	DIMENSIONS	CARACTÉRISTIQUES SPECIFICATIONS	CONDITIONNEMENT PACKING	LIV/PCB
FCO101062 Canon	135 mm	ABS - PA	LS / Pegboardable	10/280
FCO100761 Canon	135 mm	ABS - PA	Vrac / Bulk	12/144
FCO201362 Mine / Lead	135 mm	ABS - PA	LS / Pegboardable	10/280
FCO200961 Mine / Lead	135 mm	ABS - PA	Vrac / Bulk	12/144

TRACER - MESURER

Trace - Measure

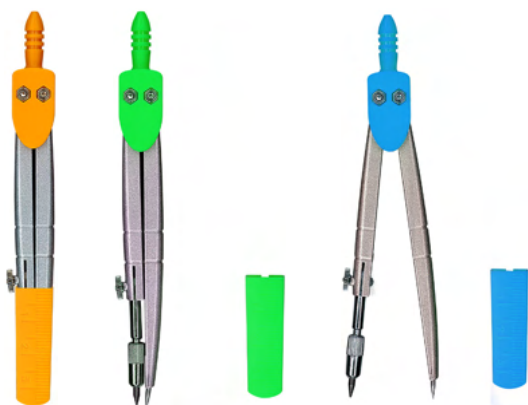

COMPAS MINE

Lead compass

Corps métal, embout ABS - Metal body, ABS tip

Guide à crémaillère - Rack guide

Vis de réglage - Tightening screw

Protection de la pointe - Protected point

REF.	DIMENSIONS	CARACTÉRISTIQUES SPECIFICATIONS	CONDITIONNEMENT PACKING	LIV/PCB
FCO201171	120 mm	ABS / ABS Métal / Metal	Vrac / Bulk	48/384



COMPAS MINE « COMPAK' »

« Compak' » lead compasses

Compas corps métal et embouts ABS dans un coffret plastique - Metal body and ABS tips compass in plastic case

Guide à crémaillère - Rack guide

Vis de réglage - Tightening screw

Protection de la pointe - Protected point

REF.	DIMENSIONS	CARACTÉRISTIQUES SPECIFICATIONS	CONDITIONNEMENT PACKING	LIV/PCB
FCO200073	130 mm	ABS / ABS Métal / Metal	Vrac / Bulk	36/216



COFFRET COMPAS MINE

Lead compass's set

Corps métal, embout ABS - Metal body, ABS tip

Guide à crémaillère - Rack guide

Vis de réglage - Tightening screw

Protection de la pointe - Protected point

REF.	DIMENSIONS	CARACTÉRISTIQUES SPECIFICATIONS	CONDITIONNEMENT PACKING	LIV/PCB
FCO201472	120 mm	ABS / ABS Métal / Metal	LS / Pegboardable	12/144

ÉTUI DE MINES DE RECHANGE

Plastic tube with spare leads

12 mines - 12 leads

+ 1 Taille-mine - Lead sharpener



REF.	DIMENSIONS	CARACTÉRISTIQUES SPECIFICATIONS	CONDITIONNEMENT PACKING	LIV/PCB
FCO900062	-		LS / Pegboardable	10/600



COFFRETS COMPAS MINE Lead compasses' set

Corps métal, embout ABS - Metal body, ABS tip
Guide à crémaillère - Rack guide
Vis de réglage - Tightening screw
Protection de la pointe - Protected point

Coffret 2 pièces - 2 pieces set
+ 1 étui de 1 mine de rechange - 1 plastic tube with 1 spare lead

REF.	DIMENSIONS	CARACTÉRISTIQUES SPECIFICATIONS	CONDITIONNEMENT PACKING	LIV/PCB
FCO200172	123 mm		LS Pegboardable	5/200



2 PCS



3 PCS

Coffret 3 pièces - 3 pieces set
+ 1 étui de 1 mine de rechange - 1 plastic tube with 1 spare lead
+ 1 taille-mine - 1 lead sharpener

REF.	DIMENSIONS	CARACTÉRISTIQUES SPECIFICATIONS	CONDITIONNEMENT PACKING	LIV/PCB
FCO200272	123 mm		LS Pegboardable	5/200



5 PCS



6 PCS

Coffret 5 pièces - 5 pieces set
+ 1 étui de 1 mine de rechange - 1 plastic tube with 1 spare lead
+ 1 taille-mine - 1 lead sharpener
+ 1 tire-lignes - 1 drawing pen
+ 1 manche porte tire-ligne plastique + Plastic holder for drawing pen

REF.	DIMENSIONS	CARACTÉRISTIQUES SPECIFICATIONS	CONDITIONNEMENT PACKING	LIV/PCB
FCO200372	120 mm		LS Pegboardable	5/200

Coffret 6 pièces - 6 pieces set
+ 1 étui de 1 mine de rechange - 1 plastic tube with 1 spare lead
+ 1 tire-lignes - 1 drawing pen
+ 1 manche porte tire-ligne plastique - Plastic holder for drawing pen
+ 1 pointe sèche - 1 dry-point compass
+ 1 tire-ligne métal avec manche plastique - Metal drawing pen with plastic holder

REF.	DIMENSIONS	CARACTÉRISTIQUES SPECIFICATIONS	CONDITIONNEMENT PACKING	LIV/PCB
FCO200672*	120 mm		LS Pegboardable	10/120

* Jusqu'à épuisement des stocks

TRACER - MESURER

Trace - Measure



COFFRET COMPAS CANON 2 PIÈCES 2 pieces canon compass'set

Corps métal, embout ABS - Metal body, ABS tip
Guide à crémaillère - Rack guide
Vis de réglage - Tightening screw
+ 1 crayon - 1 pencil

REF.	DIMENSIONS	CARACTÉRISTIQUES SPECIFICATIONS	CONDITIONNEMENT PACKING	LIV/PCB
FCO100272	-		LS Pegboardable	5/180

* Jusqu'à épuisement des stocks



COFFRETS COMPAS MINE Lead compasses'set

Corps métal, embout ABS - Metal body, ABS tip
Guide à crémaillère - Rack guide
Vis de réglage - Tightening screw

Coffret 2 pièces - 2 pieces set
1 tire-ligne métal - Metal drawing pen
+ 1 étui de 1 mine de rechange - 1 plastic tube with 1 spare lead

REF.	DIMENSIONS	CARACTÉRISTIQUES SPECIFICATIONS	CONDITIONNEMENT PACKING	LIV/PCB
FCO200772*	-		LS Pegboardable	5/180

* Jusqu'à épuisement des stocks

Coffret 3 pièces - 3 pieces set
+ 1 bague d'attache universelle - Universal fastening ring
+ 1 étui de 1 mine de rechange - 1 plastic tube with 1 spare lead

REF.	DIMENSIONS	CARACTÉRISTIQUES SPECIFICATIONS	CONDITIONNEMENT PACKING	LIV/PCB
FCO300072	-		LS Pegboardable	5/180

Coffret 5 pièces - 5 pieces set
+ 1 tire-lignes métal + 1 manche porte tire-lignes en plastique - Metal drawing pen + 1 plastic holder for drawing pen
+ 1 pointe sèche - 1 dry-point compass
+ 1 étui de 1 mine de rechange - 1 plastic tube with 1 spare lead

REF.	DIMENSIONS	CARACTÉRISTIQUES SPECIFICATIONS	CONDITIONNEMENT PACKING	LIV/PCB
FCO300172*	-		LS Pegboardable	5/180

* Jusqu'à épuisement des stocks



2 PCS

3 PCS

5 PCS



3 PCS



5 PCS



8 PCS

COFFRETS COMPAS DE PRÉCISION ARTICULÉS À BALUSTRE Technical baluster articulated compasses' set

Corps métal, embouts ABS - Metal body, ABS tips

Guide à crémaillère - Rack guide

Molette centrale à réglage micrométrique - Central wheel with micrometric adjustment

Ouverture 320 mm, 2 articulations - 320 mm opening, double articulation

Vis de réglage, réglage rapide - Tightening screw, rapid adjustment

Coffret 3 pièces - 3 pieces set

+ 1 bague d'attache universelle - Universal fastening ring

+ 1 étui de 1 mine de rechange - 1 plastic tube with 1 spare lead

REF.	DIMENSIONS	CARACTÉRISTIQUES SPECIFICATIONS	CONDITIONNEMENT PACKING	LIV/PCB
FCO300572	170 mm		LS / Pegboardable	10/80

Coffret 5 pièces - 5 pieces set

+ 1 bague d'attache universelle - Universal fastening ring

+ 1 rallonge - Extension

+ 1 étui de 1 mine de rechange - 1 plastic tube with 1 spare lead

+ 1 Taille-mine - Lead sharpener

REF.	DIMENSIONS	CARACTÉRISTIQUES SPECIFICATIONS	CONDITIONNEMENT PACKING	LIV/PCB
FCO300372	283 x 200 mm		LS / Pegboardable	1/60

Coffret 8 pièces - 8 pieces set

+ 1 tire-ligne + 1 pointe sèche - Drawing pen + 1 dry-point compass

+ 1 bague d'attache universelle - Universal fastening ring

+ 1 manche porte tire-ligne en plastique - Plastic holder for drawing pen

+ 1 tire-ligne métal + 1 manche plastique - Metal drawing pen with plastic holder

+ 1 compas mine métal à balustre - Metal baluster lead compass

+ 1 étui de 1 mine de rechange - 1 plastic tube with 1 spare lead

REF.	DIMENSIONS	CARACTÉRISTIQUES SPECIFICATIONS	CONDITIONNEMENT PACKING	LIV/PCB
FCO300272	283 x 200 mm		LS / Pegboardable	10/100

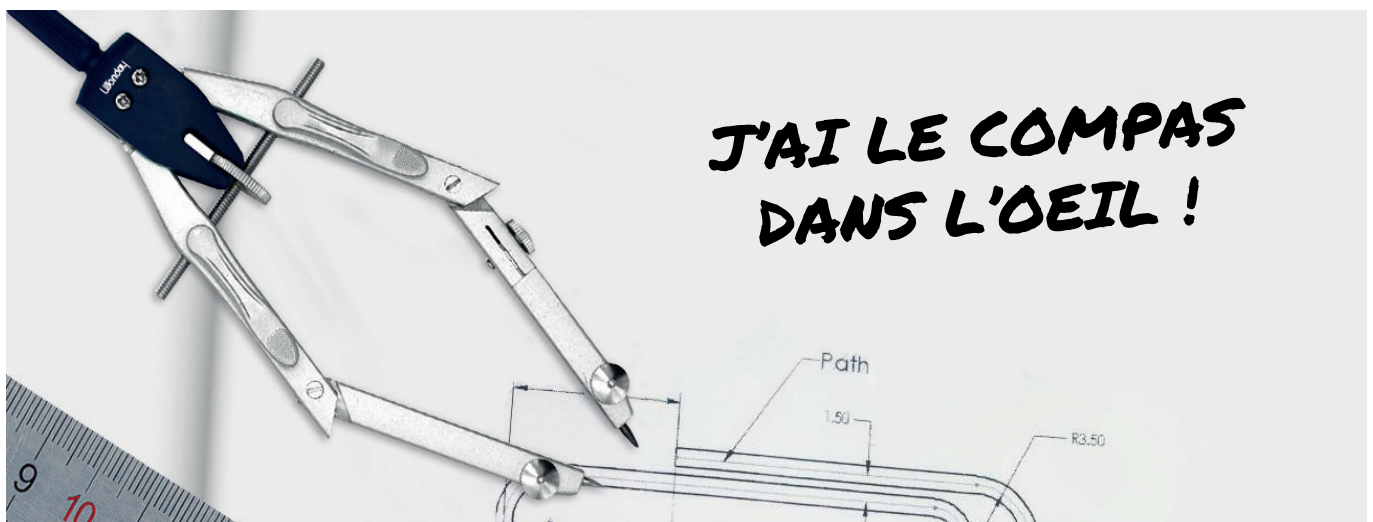

**J'AI LE COMPAS
DANS L'OEIL !**

TRACER - MESURER

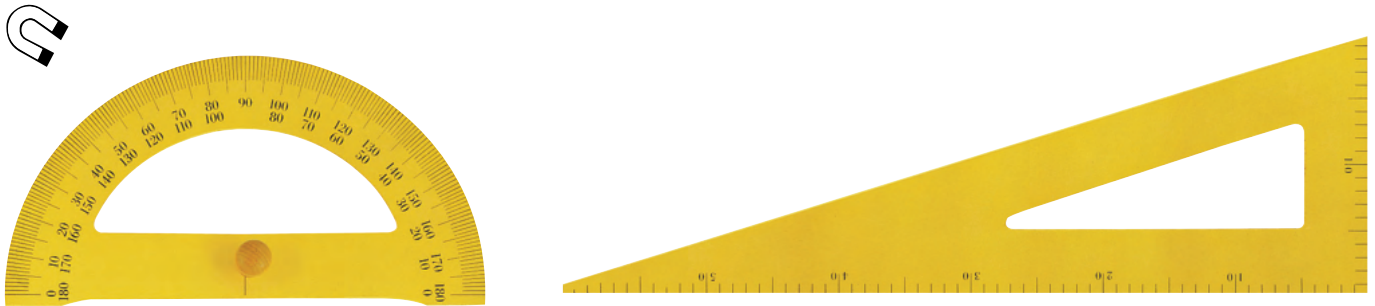

Trace - Measure

TRAÇAGE POUR TABLEAUX / TRACING FOR BOARDS



TRAÇAGE EN BOIS LAQUÉ POUR TABLEAU MAGNÉTIQUE Magnetic lacquered wooden tracing

Règle plate 1 m avec bouton - 1 m flat ruler with knob
Équerre ajourée 60° - 60 cm - 60° - 60 cm square
Rapporteur 180° - 35 cm avec bouton - 180° - 35 cm protractor with knob









MODÈLE MODEL	REF.	DIMENSIONS	CARACTÉRISTIQUES SPECIFICATIONS	CONDITIONNEMENT PACKING	UV/PCB
Règle Ruler	FTA010041	1 m		Vrac / Bulk	2/48
Équerre Square set	FTA610041	60° - 60 cm		Vrac / Bulk	3/60
Rapporteur Protractor	FTA810041	180° - 35 cm		Vrac / Bulk	3/48



TRAÇAGE PLASTIQUE 100 % RECYCLÉ POUR TABLEAU MAGNÉTIQUE Magnetic tracing in 100% recycled plastic

Poignée amovible - Removable handle
Incassable - Shatterproof
Règle plate 1 m - 1 m flat ruler
Équerre ajourée 60° - 50 cm - 60° - 50 cm square
Équerre ajourée 45° - 60 cm - 45° - 60 cm square
Rapporteur 180° - 50 cm - 180° - 50 cm protractor
Set de 3 pièces : 1 règle 1 m, 1 équerre 60° - 50 cm et 1 rapporteur 180° - 50 cm
- Set of 3 pieces : 1 m ruler, 60° - 50 cm square and 180° - 50 cm protractor



MODÈLE MODEL	REF.	DIMENSIONS	CARACTÉRISTIQUES SPECIFICATIONS	CONDITIONNEMENT PACKING	UV/PCB
Règle Ruler	FTA010161	1 m	 	Vrac / Bulk	1/40
Équerre Square	FTA610161	60° - 50 cm	 	Vrac / Bulk	1/40
Rapporteur Protractor	FTA810161	180° - 50 cm	 	Vrac / Bulk	1/40
Set	FTA910061	-	 	Vrac / Bulk	1/20

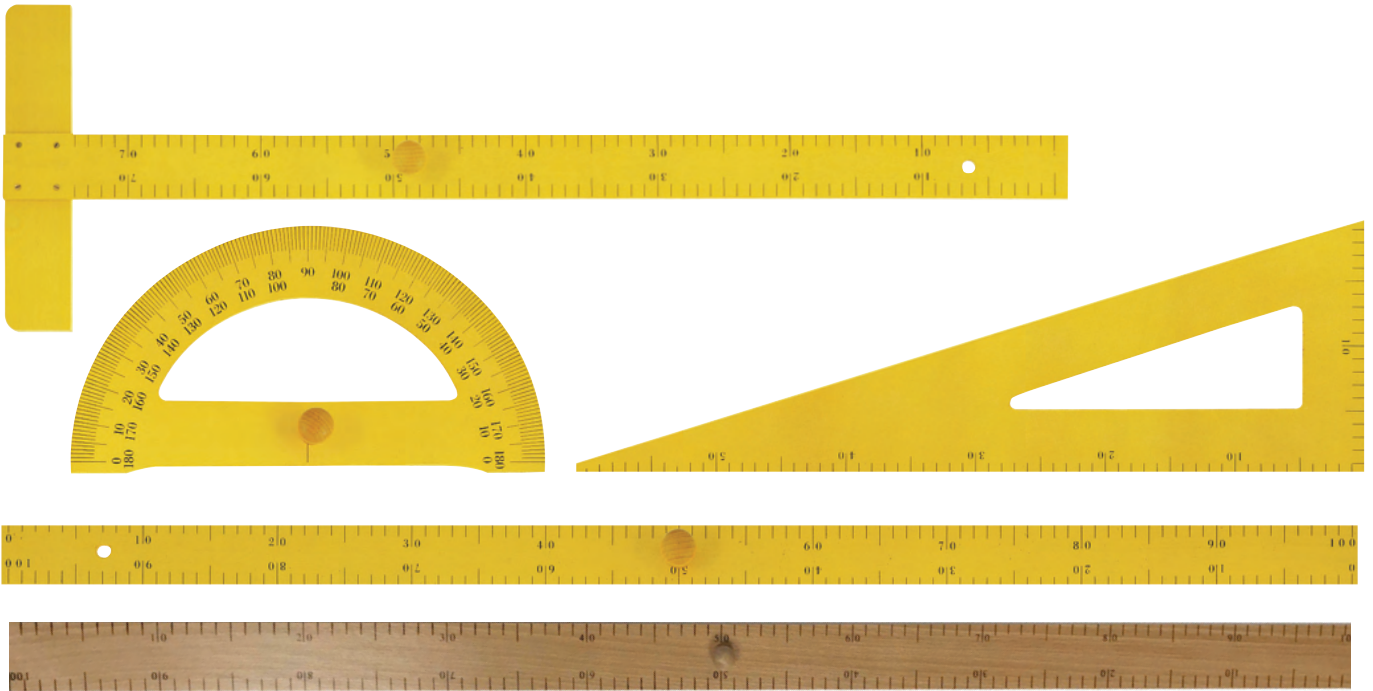

TRAÇAGE POUR TABLEAU EN BOIS Tracing for wooden board

Té 75 cm en bois laqué avec bouton - 75 cm lacquered wood T-ruler with knob
 Règle plate 1 m en bois laqué avec bouton - 1 m lacquered wood flat ruler with knob
 Règle plate 1 m en bois vernis avec bouton - Varnished wood - 1 m flat ruler with knob
 Équerre en bois laqué ajourée 60° - 60 cm - 60° - 60 cm lacquered wood square
 Rapporteur en bois laqué 180° - 35 cm avec bouton - 180° - 35 cm lacquered wood protractor with knob

MODÈLE MODEL	REF.	DIMENSIONS	CARACTÉRISTIQUES SPECIFICATIONS	CONDITIONNEMENT PACKING	UV/PCB
Té T-ruler	FTA100041*	75 cm		Vrac / Bulk	2/20
Règle Ruler	FTA000041	1 m		Vrac / Bulk	2/48
Règle Ruler	FTA000141*	1 m		Vrac / Bulk	2/48
Équerre Square	FTA600041	60° - 60 cm		Vrac / Bulk	3/60
Rapporteur Protractor	FTA800041	180° - 35 cm		Vrac / Bulk	3/48

* Jusqu'à épuisement des stocks

COMPAS POUR TABLEAU EN BOIS BRUT Compasses for wooden board

Compas 40 cm pour tableau noir avec pointe sèche - 40 cm blackboard compass with dry-point
 Compas 40 cm pour tableau noir avec ventouse - 40 cm blackboard compass with suction cup
 Compas 40 cm pour tableau blanc avec ventouse - 40 cm whiteboard compass with suction cup



MODÈLE MODEL	REF.	TAILLE SIZE	CARACTÉRISTIQUES SPECIFICATIONS	CONDITIONNEMENT PACKING	UV/PCB
Pointe sèche tableau noir Dry-point compass blackboard	FTA200041	40 cm		Vrac / Bulk	3/60
Ventouse tableau noir Suction cup blackboard	FTA250041	40 cm		Vrac / Bulk	3/60
Ventouse tableau blanc Suction cup whiteboard	FTA250141	40 cm		Vrac / Bulk	3/60

TRACER - MESURER

Trace - Measure



DURABLE
RE-PLASTIC®
100% RECYCLÉ



TRAÇAGE PLASTIQUE 100 % RECYCLÉ POUR TABLEAU Tracing in 100% recycled plastic for board

Poignée amovible - Removable handle

Incassable - Shatterproof

Règle plate 1 m - 1 m flat ruler

Équerre ajourée 60° - 50 cm - 60° - 50 cm square

Rapporteur 180° - 50 cm - 180° - 50 cm protractor

Compas 50 cm pour craie pour tableau noir avec 1 ventouse - 50 cm compass for chalk for blackboard with 1 suction cup

MODÈLE MODEL	REF.	DIMENSIONS	CARACTÉRISTIQUES SPECIFICATIONS	CONDITIONNEMENT PACKING	UV/PCB
Règle Ruler	FTA000361	1 m		Vrac / Bulk	1/40
Équerre Square	FTA600261	60° - 50 cm		Vrac / Bulk	1/40
Rapporteur Protractor	FTA800261	180° - 50 cm		Vrac / Bulk	1/40
Compas Compass	FTA250361	50 cm		Vrac / Bulk	1/65

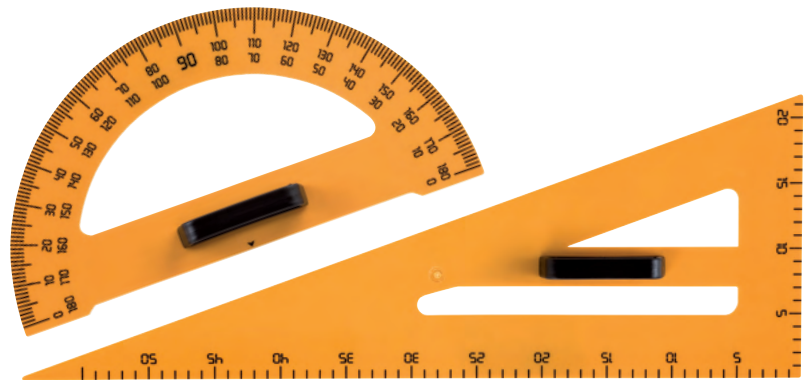

TRAÇAGE PLASTIQUE POUR TABLEAU Plastic tracing for board

Règle plate 1 m avec poignée - 1 m flat ruler with handle

Équerre ajourée 60° - 60 cm avec poignée - 60° - 60 cm square with handle

Rapporteur 180° - 35 cm avec poignée - 180° - 35 cm protractor with handle

Compas 45 cm pour tableau noir ou blanc avec pointe sèche ou ventouse et adaptateur craie ou marqueur - 35 cm compass for blackboard or whiteboard with dry-point compass or suction cup and adapter chalk or marker

MODÈLE MODEL	REF.	DIMENSIONS	CARACTÉRISTIQUES SPECIFICATIONS	CONDITIONNEMENT PACKING	UV/PCB
Règle Ruler	FTA000261	1 m		Vrac / Bulk	1/50
Équerre Square	FTA600161	60° - 60 cm		Vrac / Bulk	1/50
Rapporteur Protractor	FTA800161	180 - 35 cm		Vrac / Bulk	1/50
Compas Compass	FTA300061	45 cm		Vrac / Bulk	1/20

TRAÇAGE / TRACING

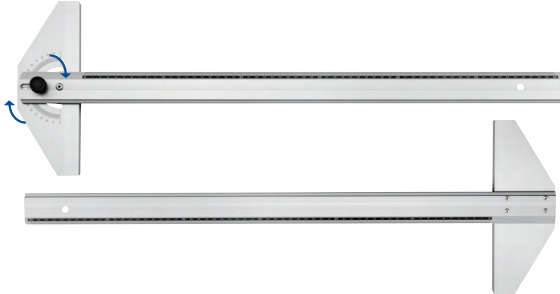

TÉS ALUMINIUM Aluminium T-rulers



En aluminium anodisé - In anodised aluminium
1 biseau gradué en mm - 1 bevel scaled in mm

MODÈLE MODEL	REF.	DIMENSIONS	CARACTÉRISTIQUES SPECIFICATIONS	CONDITIONNEMENT PACKING	LIV/PCB
Tête mobile Moving head	FTT870372	60 cm		LS / Pegboardable	1/15
Tête fixe Fixed-head	FTT870272	60 m		LS / Pegboardable	1/15

GAMME ALUTECH - ALUTECH LINE

En aluminium anodisé - In anodised aluminium | Graduation en mm - Scales in mm
Pour tous travaux techniques et professionnels - For any technical and professional works



RÈGLES PLATES ALUMINIUM « ALUTECH » « Alu'tech » aluminium flat rulers

1 biseau gradué en mm - 1 bevel scaled in mm
Bande antidérapante - Non-slip strip
Bord antitache - Anti-stain edge

REF.	DIMENSIONS	CARACTÉRISTIQUES SPECIFICATIONS	CONDITIONNEMENT PACKING	LIV/PCB
FTT200072	20 cm		LS / Pegboardable	10/200
FTT300072	30 cm		LS / Pegboardable	10/100
FTT400072	40 cm		LS / Pegboardable	10/100
FTT500072	50 cm		LS / Pegboardable	10/100
FTT600072	60 cm		LS / Pegboardable	10/50
FTT000171	100 cm		Vrac / Bulk	10/50



RAPPEUR ALUMINIUM « ALUTECH » « Alu'tech » aluminium protractor

1 biseau gradué en mm - 1 bevel scaled in mm

REF.	DIMENSIONS	CARACTÉRISTIQUES SPECIFICATIONS	CONDITIONNEMENT PACKING	LIV/PCB
FTT850072	180° - 15 cm		LS / Pegboardable	10/200



DOUBLE ET TRIPLE DÉCIMÈTRES ALUMINIUM « ALUTECH » « Alu'tech » 20 and 30 cm aluminium rulers

2 biseaux gradués en mm - 2 bevels scaled in mm

REF.	DIMENSIONS	CARACTÉRISTIQUES SPECIFICATIONS	CONDITIONNEMENT PACKING	LIV/PCB
FTT220072	20 cm		LS / Pegboardable	10/200
FTT330072	30 cm		LS / Pegboardable	10/100

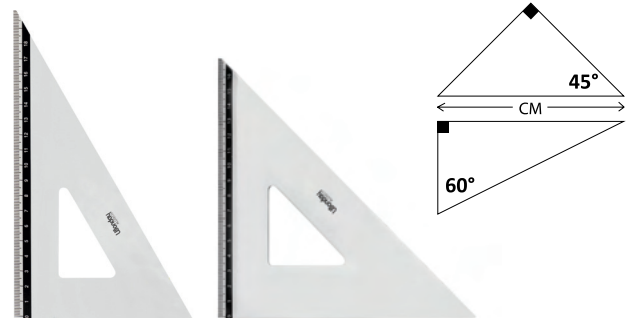

ÉQUERRES ALUMINIUM « ALUTECH » « Alu'tech » aluminium squares

1 biseau gradué en mm - 1 bevel scaled in mm

REF.	DIMENSIONS	CARACTÉRISTIQUES SPECIFICATIONS	CONDITIONNEMENT PACKING	LIV/PCB
FTT750072	60° - 25 cm		LS / Pegboardable	10/120
FTT700072	45° - 25 cm		LS / Pegboardable	10/120

TRACER - MESURER

Trace - Measure

**TRACE DROIT
DEVANT TOI!**

GAMME ALUDIC - ALUDIC RANGE



SET DE TRAÇAGE ALUMINIUM 3 PIÈCES Aluminium tracing set 3 pieces

1 biseau gradué en mm - 1 bevel scaled in mm
Règle 30 cm avec bord antitache - 30 cm ruler with anti-stain edge
Equerre 60° - 21 cm - 60° - 21 cm square set
Rapporteur 180° - 15 cm - 180° - 15 cm protractor

REF.	DIMENSIONS	CARACTÉRISTIQUES SPECIFICATIONS	CONDITIONNEMENT PACKING	LIV/PCB
FTT030072	-		LS / Pegboardable	10/60



RAPPORTEUR ALUMINIUM Aluminium protractor

1 biseau gradué en mm - 1 bevel scaled in mm

REF.	DIMENSIONS	CARACTÉRISTIQUES SPECIFICATIONS	CONDITIONNEMENT PACKING	LIV/PCB
FTT850172	180° - 15 cm		LS / Pegboardable	10/240



RÈGLES PLATES ALUMINIUM Aluminium flat rulers

1 biseau gradué en mm - 1 bevel scaled in mm
Bord antitache - Anti-stain edge

REF.	DIMENSIONS	CARACTÉRISTIQUES SPECIFICATIONS	CONDITIONNEMENT PACKING	LIV/PCB
FTT200172	20 cm		LS / Pegboardable	10/120
FTT300172	30 cm		LS / Pegboardable	10/120
FTT400172	40 cm		LS / Pegboardable	10/120
FTT500172	50 cm		LS / Pegboardable	10/120

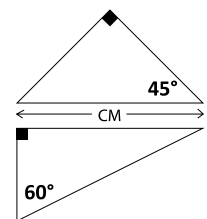

ÉQUERRES ALUMINIUM Aluminium square set

1 biseau gradué en mm - 1 bevel scaled in mm

REF.	DIMENSIONS	CARACTÉRISTIQUES SPECIFICATIONS	CONDITIONNEMENT PACKING	LIV/PCB
FTT750172	60° - 21 cm		LS / Pegboardable	10/240
FTT700172	45° - 21 cm		LS / Pegboardable	10/240

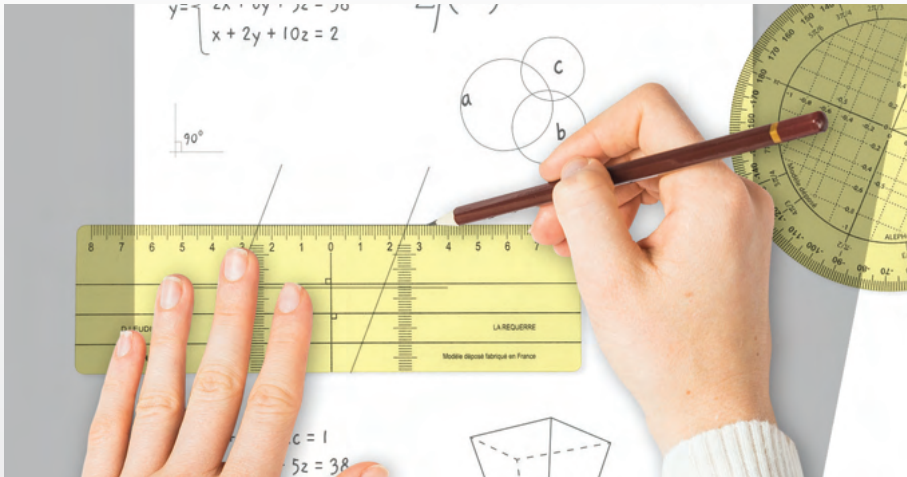

Les outils pédagogiques créés par Aleph ont tous été conçus par des professeurs de mathématiques. Ils sont destinés aux professeurs de mathématiques et de sciences et à leurs élèves. Plus de 1500 établissements français les utilisent déjà. Son matériau en plastique translucide est souple, incassable et irrayable.

The teaching tools created by Aleph were all designed by mathematics teachers. They are intended for mathematics and science teachers and their students. More than 1500 French schools already use them. Its translucent plastic material is flexible, unbreakable and scratch-resistant.

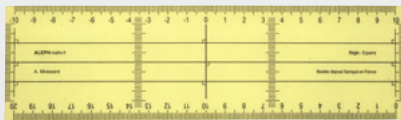

RÈGLE-ÉQUERRE Square-ruler

Elles remplacent l'équerre et la règle - They replace the square and the ruler
Elles permettent de construire facilement des hauteurs, des droites perpendiculaires, des droites parallèles, des médiatrices ainsi que toutes les constructions de figures à symétrie axiale ou centrale - They make it possible to easily construct heights, perpendicular lines, parallel lines, median lines, as well as all constructions of axially or centrally symmetrical figures
17 ou 21 cm - 17 or 21 cm
Double graduation - Double scales

REF.	DIMENSIONS	CARACTÉRISTIQUES SPECIFICATIONS	CONDITIONNEMENT PACKING	LIV/PCB
FTT170362	17 cm		LS / Pegboardable	25/25
FTT210162	21 cm		LS / Pegboardable	25/25

RÉQUERRE Requerre

Elles remplacent l'équerre et la règle - They replace the square and the ruler
Elles permettent de construire facilement des hauteurs, des droites perpendiculaires, des droites parallèles, des médiatrices ainsi que toutes les constructions de figures à symétrie axiale ou centrale - They make it possible to easily construct heights, perpendicular lines, parallel lines, median lines, as well as all constructions of axially or centrally symmetrical figures
16 cm - 16 cm

REF.	DIMENSIONS	CARACTÉRISTIQUES SPECIFICATIONS	CONDITIONNEMENT PACKING	LIV/PCB
FTT170162	16 cm		LS / Pegboardable	25/25

RAPPORTEUR TRIGONOMÉTRIE Trigonometric protractor

Le rapporteur trigonométrie permet la lecture directe de la mesure des angles en degrés et en radians, ainsi que des valeurs des cosinus et des sinus à 0,05 près - The trigonometric protractor allows direct reading of angle measurements in degrees and radians, as well as cosine and sine values to within 0.05
Il permet d'estimer la valeur approchée du cosinus et du sinus d'un angle - It allows to estimate the approximate value of the cosine and sine of an angle.
Diamètre 110 mm - Diameter 110 mm

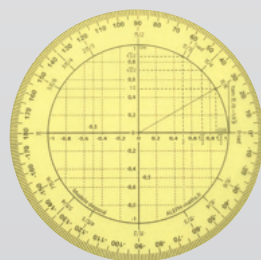

REF.	DIMENSIONS	CARACTÉRISTIQUES SPECIFICATIONS	CONDITIONNEMENT PACKING	LIV/PCB
FTT860162	360° - Ø 110 mm		LS / Pegboardable	25/25

RAPPORTEUR GÉOMÉTRIE Geometry protractor

Le rapporteur géométrie présente une graduation unique dans le sens trigonométrique - The geometry protractor has a unique graduation in the trigonometric direction
Le centre, l'origine de la graduation et le sens de lecture sont bien visibles - The centre, the origin of the graduation and the reading direction are clearly visible
Il permet la mesure des angles obtus et rentrants et il prépare aux cours de trigonométrie - It allows the measurement of obtuse and re-entrant angles and prepares for trigonometry lessons
Diamètre 110 mm - Diameter 110 mm

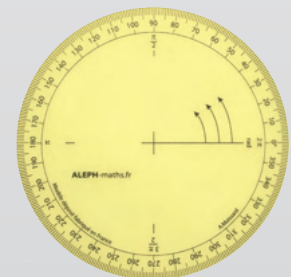

REF.	DIMENSIONS	CARACTÉRISTIQUES SPECIFICATIONS	CONDITIONNEMENT PACKING	LIV/PCB
FTT860362	360° - Ø 110 mm		LS / Pegboardable	25/25

GAMME À MÉMOIRE DE FORME « ELASTIKA » SHAPE MEMORY INSTRUMENTS « ELASTIKA » LINE

Graduation en mm gravée ineffaçable - Indelible engraved scales in mm | Haute qualité - High quality
Bord antitache - Anti-stain edge



DOUBLE ET TRIPLE DÉCIMÈTRES FLEXIBLES 20 and 30 cm flexible rulers

REF.	DIMENSIONS	CARACTÉRISTIQUES SPECIFICATIONS	CONDITIONNEMENT PACKING	LIV/PCB
EL20P	20 cm		LS Pegboardable	10/200
EL30P	30 cm		LS Pegboardable	10/240

RÈGLES PLATES FLEXIBLES Flexible flat rulers

REF.	DIMENSIONS	CARACTÉRISTIQUES SPECIFICATIONS	CONDITIONNEMENT PACKING	LIV/PCB
EL30	30 cm		LS Pegboardable	10/200
EL50	50 cm		LS Pegboardable	10/300

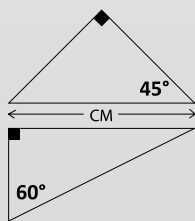
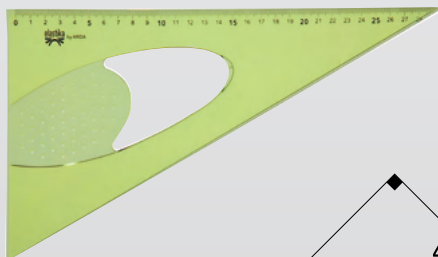
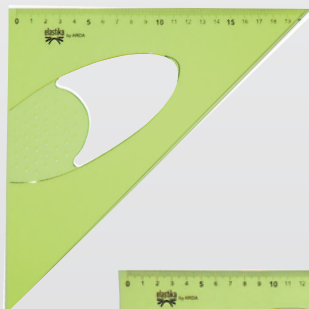

ÉQUERRES FLEXIBLES Flexible squares

REF.	DIMENSIONS	CARACTÉRISTIQUES SPECIFICATIONS	CONDITIONNEMENT PACKING	LIV/PCB
EL6020	60° - 20 cm		LS Pegboardable	10/320
EL6030	60° - 30 cm		LS Pegboardable	10/200
EL6035	60° - 35 cm		LS Pegboardable	10/100
EL4520	45° - 20 cm		LS Pegboardable	10/300
EL4530	45° - 30 cm		LS Pegboardable	10/220
EL4535	45° - 35 cm		LS Pegboardable	10/140

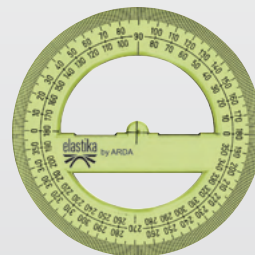

RAPORTEURS FLEXIBLES Flexible protractors

REF.	DIMENSIONS	CARACTÉRISTIQUES SPECIFICATIONS	CONDITIONNEMENT PACKING	LIV/PCB
EL18012	180° - 12 cm		LS Pegboardable	10/300
EL36012	360° - 12 cm		LS Pegboardable	10/200



* dans les conditions normales d'utilisation



GAMME TROMB'LINE INCASSABLE SHATTERPROOF TROMB'LINE RANGE

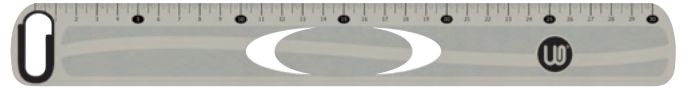
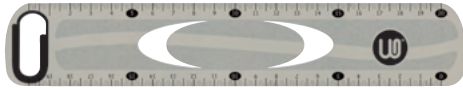

DOUBLE ET TRIPLE DÉCIMÈTRES INCASSABLES Shatterproof 20 and 30 cm rulers

2 biseaux gradués en mm - 2 bevels scaled in mm
Corps plastique 80 % R-PET - 80 % R-PET plastic body

REF.	DIMENSIONS	CARACTÉRISTIQUES SPECIFICATIONS	CONDITIONNEMENT PACKING	LIV/PCB
FTS220362	20 cm		LS / Pegboardable	20/200
FTS330262	30 cm		LS / Pegboardable	20/200

RÈGLES PLATES INCASSABLES Shatterproof flat rulers

1 biseau gradué en mm - 1 bevel scaled in mm
Corps plastique 80 % R-PET - 80 % R-PET plastic body
Bord antitache - Anti-stain edge

REF.	DIMENSIONS	CARACTÉRISTIQUES SPECIFICATIONS	CONDITIONNEMENT PACKING	LIV/PCB
FTS200262	20 cm		LS / Pegboardable	20/200
FTS300362	30 cm		LS / Pegboardable	20/200
FTS400262	40 cm		LS / Pegboardable	20/100

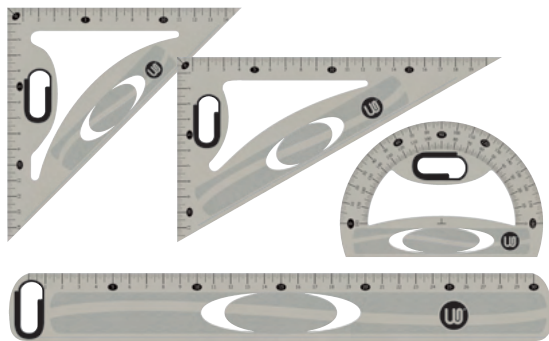

SET 4 PIÈCES INCASSABLES Shatterproof set 4 pieces

Règle plate 30 cm - 30 cm flat ruler
Équerres 60° - 15 cm et 45° - 21 cm - Squares 60° - 15 cm and 45° - 21 cm
Rapporteur 180° - 12 cm - 180° - 12 cm protractor
Corps plastique 80 % R-PET - 80 % R-PET plastic body
Livré sous pochette carton - Delivered in cardboard pouch

REF.	DIMENSIONS	CARACTÉRISTIQUES SPECIFICATIONS	CONDITIONNEMENT PACKING	LIV/PCB
FTS040262	-		LS / Pegboardable	10/60

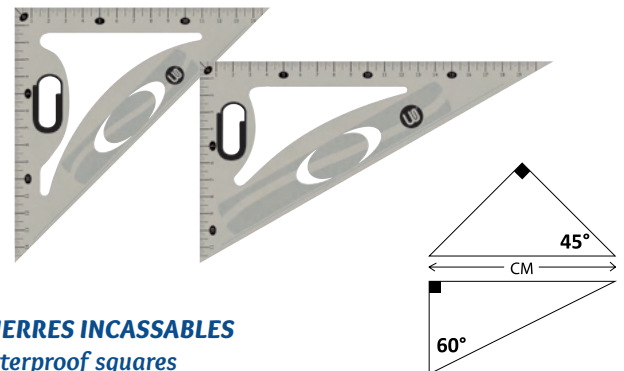

ÉQUERRES INCASSABLES Shatterproof squares

1 biseau gradué en mm - 1 bevel scaled in mm
Indication de l'angle droit - Shows right angle
Bord antitache - Anti-stain edge
Corps plastique 80 % R-PET - 80 % R-PET plastic body

REF.	DIMENSIONS	CARACTÉRISTIQUES SPECIFICATIONS	CONDITIONNEMENT PACKING	LIV/PCB
FTS750662	60° - 21 cm		LS / Pegboardable	20/200
FTS700462	45° - 21 cm		LS / Pegboardable	20/200

RAPPORTEUR INCASSABLE Shatterproof protractor

Double graduation en degrés - Double graduation in degrees
Corps plastique 80 % R-PET - 80 % R-PET plastic body

REF.	DIMENSIONS	CARACTÉRISTIQUES SPECIFICATIONS	CONDITIONNEMENT PACKING	LIV/PCB
FTS850262	180° - 12 cm		LS / Pegboardable	20/200



TRACER - MESURER

Trace - Measure

GAMME INCASSABLE - SHATTERPROOF RANGE



DOUBLE ET TRIPLE DÉCIMÈTRES INCASSABLES

Shatterproof 20 and 30 cm rulers

2 biseaux gradués en mm - 2 bevels scaled in mm
Poignée et corps plastique K-resin - K-resin plastic handle and body

REF.	DIMENSIONS	CARACTÉRISTIQUES SPECIFICATIONS	CONDITIONNEMENT PACKING	LIV/PCB
FTS220062	20 cm		LS / Pegboardable	12/720
FTS330062	30 cm		LS / Pegboardable	12/432

RÈGLES PLATES INCASSABLES

Shatterproof flat rulers

1 biseau gradué en mm - 1 bevel scaled in mm
Corps plastique K-resin - K-resin plastic body

REF.	DIMENSIONS	CARACTÉRISTIQUES SPECIFICATIONS	CONDITIONNEMENT PACKING	LIV/PCB
FTS200062	20 cm		LS / Pegboardable	12/720
FTS300062	30 cm		LS / Pegboardable	12/432
FTS400062	40 cm		LS / Pegboardable	12/240
FTS500062	50 cm		LS / Pegboardable	12/192

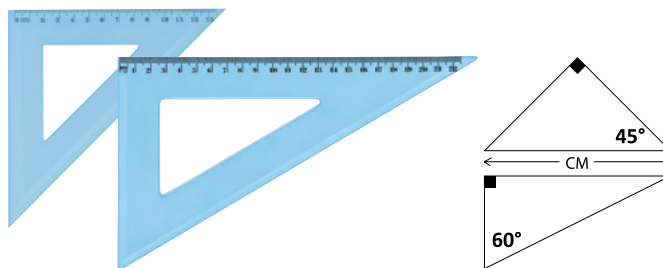
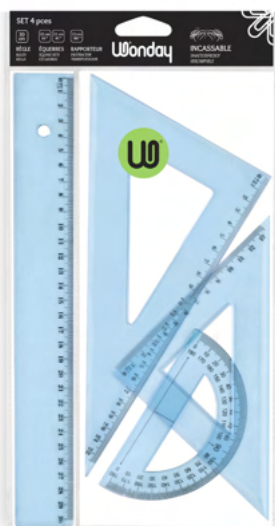

SET 4 PIÈCES INCASSABLE

Shatterproof set 4 pieces

Règle plate 30 cm - 30 cm flat ruler
Équerres 60° - 21 cm et 45° - 21 cm - Squares 60° - 21 cm and 45° - 21 cm
Rapporteur 180° - 12 cm - 180° - 12 cm protractor
Corps plastique K-resin - K-resin plastic body

REF.	DIMENSIONS	CARACTÉRISTIQUES SPECIFICATIONS	CONDITIONNEMENT PACKING	LIV/PCB
FTS040062	-		LS / Pegboardable	12/144

ÉQUERRES INCASSABLES

Shatterproof squares

1 biseau gradué en mm - 1 bevel scaled in mm
Corps plastique K-resin - K-resin plastic body

REF.	DIMENSIONS	CARACTÉRISTIQUES SPECIFICATIONS	CONDITIONNEMENT PACKING	LIV/PCB
FTS750062	60° - 15 cm		LS / Pegboardable	24/720
FTS750162	60° - 21 cm		LS / Pegboardable	24/576
FTS700062	45° - 21 cm		LS / Pegboardable	24/720
FTS700162	45° - 24 cm		LS / Pegboardable	24/576

RAPPORTEUR INCASSABLE

Shatterproof protractor

Double graduation en degrés - Double scales in degrees
Corps plastique K-resin - K-resin plastic body

REF.	DIMENSIONS	CARACTÉRISTIQUES SPECIFICATIONS	CONDITIONNEMENT PACKING	LIV/PCB
FTS850062	180° - 12 cm		LS / Pegboardable	24/1200



GAMME ÉCO - ECO RANGE



DOUBLE ET TRIPLE DÉCIMÈTRES

20 and 30 cm rulers

2 biseaux gradués en mm - 2 bevels scaled in mm
Poignée et corps plastique PS - PS plastic handle and body

REF.	DIMENSIONS	CARACTÉRISTIQUES SPECIFICATIONS	CONDITIONNEMENT PACKING	UV/PCB
FTE220062	20 cm		LS / Pegboardable	12/720
FTE330062	30 cm		LS / Pegboardable	12/432

RÈGLES PLATES

Flat rulers

1 biseau gradué en mm - 1 bevel scaled in mm
Corps plastique PS - PS plastic body

REF.	DIMENSIONS	CARACTÉRISTIQUES SPECIFICATIONS	CONDITIONNEMENT PACKING	UV/PCB
FTE200062	20 cm		LS / Pegboardable	12/720
FTE300062	30 cm		LS / Pegboardable	12/432
FTE400062	40 cm		LS / Pegboardable	12/240
FTE500062	50 cm		LS / Pegboardable	12/192

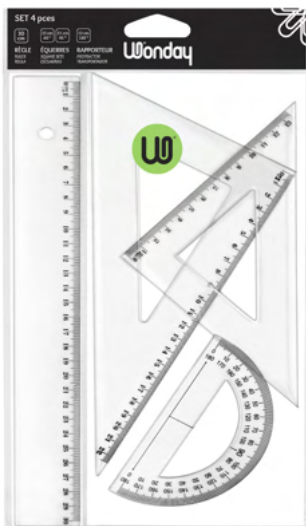

SET 4 PIÈCES

4 pieces set

Règle plate 30 cm - 30 cm flat ruler
Équerres 60° - 21 cm et 45° - 21 cm - Squares 60° - 21 cm and 45° - 21 cm
Rapporteur 180° - 12 cm - 180° - 12 cm protractor
Corps plastique PS - PS plastic body

REF.	DIMENSIONS	CARACTÉRISTIQUES SPECIFICATIONS	CONDITIONNEMENT PACKING	UV/PCB
FTE040062	-		LS / Pegboardable	12/144

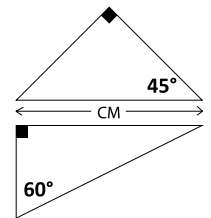

ÉQUERRES

Squares

1 biseau gradué en mm - 1 bevel scaled in mm
Indication de l'angle droit - Right angle indication
Bord antitache - Anti-stain edge
Corps plastique PS - PS plastic body

REF.	DIMENSIONS	CARACTÉRISTIQUES SPECIFICATIONS	CONDITIONNEMENT PACKING	UV/PCB
FTE750062	60° - 15 cm		LS / Pegboardable	24/720
FTE750162	60° - 21 cm		LS / Pegboardable	24/576
FTE700062	45° - 21 cm		LS / Pegboardable	24/720
FTE700162	45° - 24 cm		LS / Pegboardable	24/576

RAPPORTEURS

Protractors

Double graduation en degrés - Double scales in degrees
Corps plastique PS - PS plastic body

REF.	DIMENSIONS	CARACTÉRISTIQUES SPECIFICATIONS	CONDITIONNEMENT PACKING	UV/PCB
FTE850062	180° - 12 cm		LS / Pegboardable	24/1200
FTE860062	360° - 12 cm		LS / Pegboardable	24/576

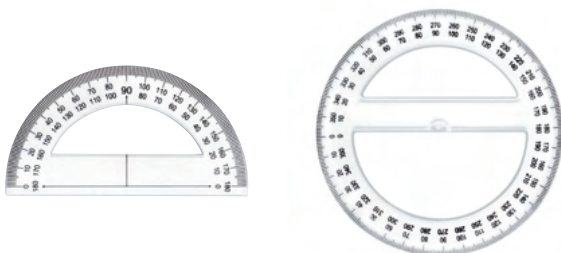

TRACER - MESURER

Trace - Measure



TÉ EN HÊTRE VERNIS Varnished beech T-ruler

Hêtre - Beech wood

Tête fixe (vissée et collée) - Fixed head (screwed and stuck)

Bord antitache - Anti-stain edge

REF.	DIMENSIONS	CARACTÉRISTIQUES SPECIFICATIONS	CONDITIONNEMENT PACKING	LIV/PCB
FTT870141	60 cm	 	Vrac / Bulk	1/50

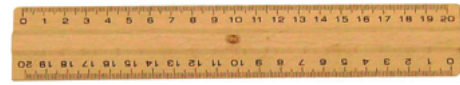

DOUBLE DÉCIMÈTRES EN BOIS VERNI Varnished wooden 20 cm ruler with handle

2 biseaux gradués en mm - 2 bevels scaled in mm

Bouton métallique - Metallic knob

REF.	DIMENSIONS	CARACTÉRISTIQUES SPECIFICATIONS	CONDITIONNEMENT PACKING	LIV/PCB
FTS220241	20 cm	 	Vrac / Bulk	20/500

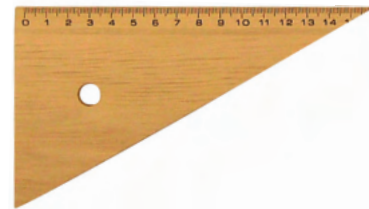

RÈGLE PLATE EN BOIS NATUREL Natural flaten wooden ruler

1 biseau gradué en mm - 1 bevel scaled in mm

REF.	DIMENSIONS	CARACTÉRISTIQUES SPECIFICATIONS	CONDITIONNEMENT PACKING	LIV/PCB
FTS300241	30 cm	 	Vrac / Bulk	10/300

ÉQUERRE EN BOIS VERNI Varnished wooden square

1 biseau gradué en mm - 1 bevel scaled in mm

Trou de suspension - Hanging hole

REF.	DIMENSIONS	CARACTÉRISTIQUES SPECIFICATIONS	CONDITIONNEMENT PACKING	LIV/PCB
FTS750541	60° - 16 cm	 	Vrac / Bulk	20/600



RÈGLES COULEURS Coloured rulers

1 biseau gradué en mm - 1 bevel scaled in mm

Bord antitache - Anti-stain edge

Lot de 36 règles - 16 cm - Set of 36 rulers - 16 cm

Coloris assortis - Assorted colours

Corps plastique PS - PS plastic body

REF.	DIMENSIONS	CARACTÉRISTIQUES SPECIFICATIONS	CONDITIONNEMENT PACKING	LIV/PCB
FTE160093	16 cm	   	Vrac / Bulk	1/20

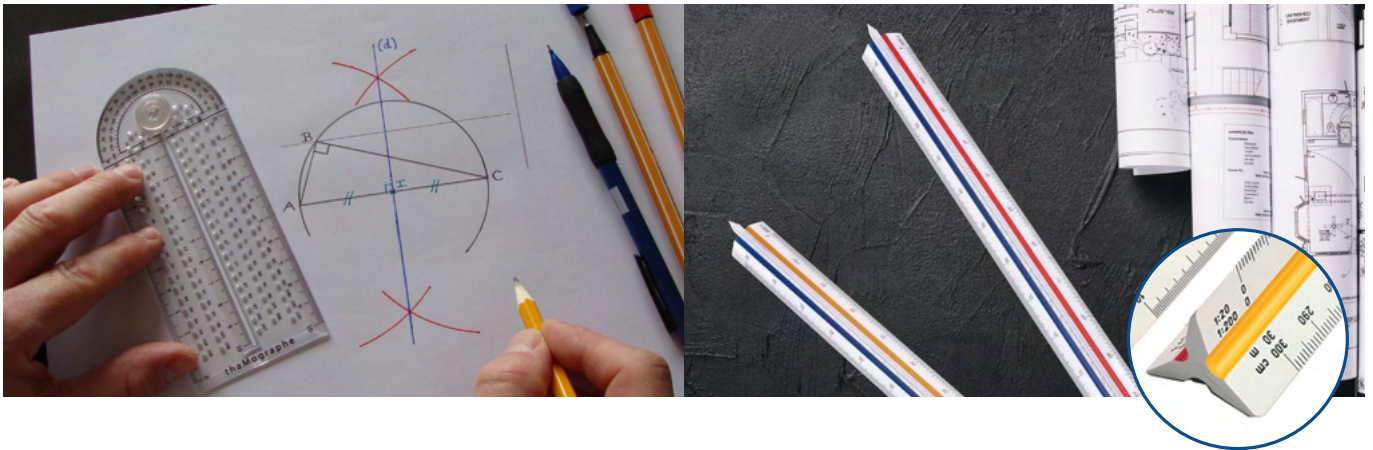

Remplace la règle, l'équerre, le rapporteur et le compas.
Replaces the ruler, square, protractor and compass.



LE THAMOGRAPHE ThaMographe

Instrument de mesure et de traçage, le ThaMographe regroupe quatre outils en un : l'équerre, le compas, le rapporteur ainsi que la règle graduée - Measuring and tracing instrument, ThaMographe combines four tools in one: square, compass, protractor and graduated ruler

Compact et facilement maniable, cet outil peut être facilement rangé dans une trousse - Compact and easy to handle, this tool can be easily stored in a pencil case
Peut effectuer des cercles allant de 10 à 110 mm de rayon, mm par mm - Can perform circles from 10 to 110 mm radius, mm by mm

Corps plastique polycarbonate (PC) - PC plastic body

REF.	DIMENSIONS	CARACTÉRISTIQUES SPECIFICATIONS	CONDITIONNEMENT PACKING	LIV/PCB
790005	10 cm		LS / Pegboardable	50/200



ÉCHELLES DE RÉDUCTION « KUTCH » «Kutch» reduction scales rulers

Plastique qualité supérieure - Plastic material high quality

Graduations précises - Precise scales

30 cm, triangulaire - 30 cm, triangular

Gorges avec code couleur - Grooves with colour codes

Etui plastique rigide - Rigid plastic case

6 combinaisons d'échelles par règle - 6-scale combination per ruler



6 modèles repérables grâce à leur pastille de couleur - 6 models identifiable thanks to their color codes

MODÈLE MODEL	REF.	CARACTÉRISTIQUES SPECIFICATIONS	CONDITIONNEMENT PACKING	LIV/PCB
	FTN350162	Ingénieur - Engineer 1 : 2,5 - 5 - 10 - 20 - 50 - 100	LS / Pegboardable	1/80
	FTN350062	Architecte I - Architect I 1 : 20-25-50-75-100-125	LS / Pegboardable	1/80
	FTN350262	Architecte II - Architect II 1 : 100-200-250-300-400-500	LS / Pegboardable	1/80
	FTN350562	Enseignement professionnel Professional teaching 1 : 20-25-33 1/3-50-75-100	LS / Pegboardable	1/80
	FTN350462	Arpentage géomètre I - Land surveying I 1 : 25-50-100-200-1440-2880	LS / Pegboardable	1/80
	FTN350362	Arpentage géomètre II - Land surveying II 1 : 500-1000-1250-1500-2000-2500	LS / Pegboardable	1/80

ARDA

TÉ PLEXIGLASS Plexiglass T-ruler

Bord antitache - Anti-stain edge

Tête mobile - Moving head

Graduation gravée haute précision - High precision engraved scale



REF.	DIMENSIONS	CARACTÉRISTIQUES SPECIFICATIONS	CONDITIONNEMENT PACKING	LIV/PCB
32160	60 cm		Vrac / Bulk	1/10

TRACER - MESURER

Trace - Measure

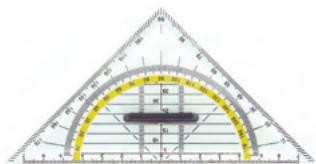

ÉQUERRE-RAPPORTEUR

Protractor-square set

Rapporteur incorporé 180° - Incorporated 180° protractor
Poignée détachable - Detachable handle
Corps plastique PS - PS plastic body

REF.	DIMENSIONS	CARACTÉRISTIQUES SPECIFICATIONS	CONDITIONNEMENT PACKING	LIV/PCB
FTT700262	Base 16 cm 16 cm basis		LS / Pegboardable	20/100



PISTOLETS À DESSIN

French curves

Polystyrène transparent fumé - Smoked transparent polystyrene
Pochette de 3 pièces - Wallet of 3 pieces
Courbes usuelles - Usual shapes
130 mm, 170 mm, 300 mm - 130 mm, 170 mm, 300 mm

REF.	DIMENSIONS	CARACTÉRISTIQUES SPECIFICATIONS	CONDITIONNEMENT PACKING	LIV/PCB
FTN000062	13, 17 et 30 cm		LS / Pegboardable	10/100

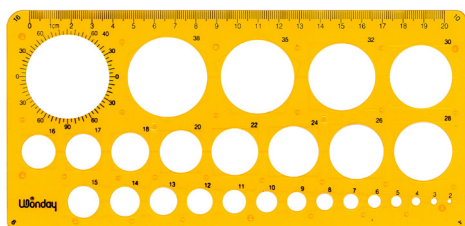

TRACE-CERCLES - Circles template

27 cercles de 2 à 40 mm - 27 circles from 2 to 40 mm
Ø pairs et impairs - Even and odd Ø
Dimensions : 22 x 10,5 cm
Plastique K-resin souple incassable avec système antistache - Shatterproof flexible K-resin plastic with anti-stain system
Gradué en mm / cm sur un côté - Graduated in mm / cm on one side

REF.	DIMENSIONS	CARACTÉRISTIQUES SPECIFICATIONS	CONDITIONNEMENT PACKING	LIV/PCB
FTN050062	22 x 10.5 cm		LS / Pegboardable	12/144

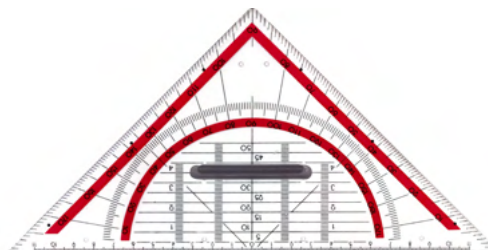

ÉQUERRE-RAPPORTEUR

Protractor-square set

Echelle opposée 180° - 0° - 180° - 0° opposite scale
Traits à 45° et 135° - 45° et 135° marks
Graduation en mm pour tracer des parallèles - Graduation in mm to draw parallels
Poignée détachable - Detachable handle
Corps plastique PS - PS plastic body

REF.	DIMENSIONS	CARACTÉRISTIQUES SPECIFICATIONS	CONDITIONNEMENT PACKING	LIV/PCB
FTT700362	Base 24 cm 24 cm basis		LS / Pegboardable	20/100



TRACE COURBE FLEXIBLE

Flexible curve ruler

Bord antistache - Anti-stain edge

REF.	DIMENSIONS	CARACTÉRISTIQUES SPECIFICATIONS	CONDITIONNEMENT PACKING	LIV/PCB
FTT510061*	50 cm		LS / Pegboardable	12/144

* Jusqu'à épaisseur des stocks

TRIPLE DÉCIMÈTRE

Triple decimeter

2 biseaux gradués en mm - 2 bevels scaled in mm

Bouton métallique central - Middle metal knob



MODÈLE MODEL	REF.	CARACTÉRISTIQUES SPECIFICATIONS	CONDITIONNEMENT PACKING	LIV/PCB
M 5301 30 cm	M79352419	Altuglas® photogravé Photograved Altuglas®		Vrac / Bulk 1/10



RÈGLES PLATES

Flat plastic rulers

1 biseau gradué en mm - 1 bevel scaled in mm

MODÈLE MODEL	REF.	CARACTÉRISTIQUES SPECIFICATIONS	CONDITIONNEMENT PACKING	LIV/PCB
M 5300 30 cm	M79352418	Altuglas® photogravé		Vrac / Bulk 1/10
M 5400 40 cm	M79352420*	Altuglas® photogravé		Vrac / Bulk 1/10
M 5500 50 cm	M79352421	Altuglas® photogravé		Vrac / Bulk 1/10
M 6100 110 cm	M79352458*	Altuglas® photogravé		Vrac / Bulk 1/10

ÉCHELLES DE RÉDUCTION « KUTCH »

«Kutch» reduction scales rulers

Corps plastique - Plastic body

Graduations précises - Precise scales

30 cm, triangulaire - 30 cm, triangular

Gorges avec code couleur - Grooves with colour code

MODÈLE MODEL	REF.	CARACTÉRISTIQUES SPECIFICATIONS	CONDITIONNEMENT PACKING	LIV/PCB
n°1315/D	M79352477*	Échelles - Scales 1/10-20-25-30-40-50		Vrac / Bulk 1/10

* Jusqu'à épuisement des stocks



RAPPORTEUR TRIGONOMÉTRIQUE

Trigonometry protractor

Graduation en degrés et radians - Degrees and radian scales

Cercle entier 360° - Circle 360°

MODÈLE MODEL	REF.	CARACTÉRISTIQUES SPECIFICATIONS	CONDITIONNEMENT PACKING	LIV/PCB
n° 1191 Ø 15 cm	M79352427*	Altuglas® photogravé Photograved Altuglas®		Vrac / Bulk 1/10

* Jusqu'à épuisement des stocks

TRI-RAPPORTEUR

Tri protractor

Graduation en degrés, grades et millièmes - Degrees, grades and thousandth scales

MODÈLE MODEL	REF.	CARACTÉRISTIQUES SPECIFICATIONS	CONDITIONNEMENT PACKING	LIV/PCB
n° 1190 17 cm	M79352470	Altuglas® photogravé Photograved Altuglas®		Vrac / Bulk 1/10

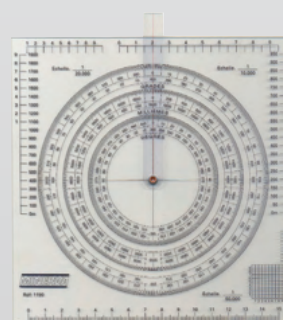

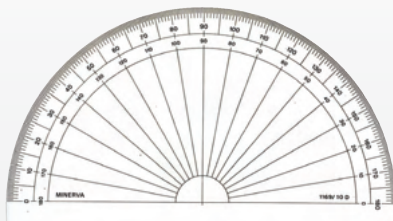

RAPPORTEURS « DEGRÉS »

«Degrees» protractor



Graduation en degrés - Degrees scales

Orientation horaire ainsi que trigonométrique - Clockwise and trigonometry

1/2 circulaire - 1/2 circle : Ø10 et 15 cm

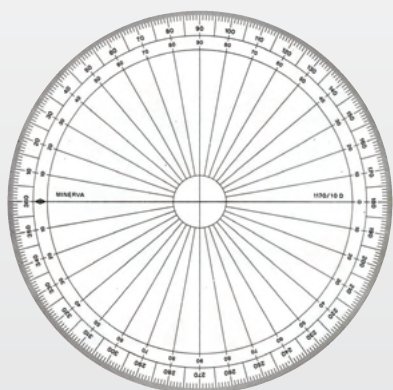
Circulaire - Circular : Ø10 cm



MODÈLE MODEL	REF.	CARACTÉRISTIQUES SPECIFICATIONS	CONDITIONNEMENT PACKING	UV/PCB
n° 1169/10D Ø10 cm	M79352422*	Altuglas® phot gravé Photographed Altuglas®		Vrac / Bulk 1/10
n° 1169/15D Ø15 cm	M79352440	Altuglas® phot gravé Photographed Altuglas®		Vrac / Bulk 1/10
n° 1170/10D Ø10 cm	M79352423*	Altuglas® phot gravé Photographed Altuglas®		Vrac / Bulk 1/20

* Jusqu'à épuisement des stocks

RAPPORTEUR « GRADES »

«Grades» protractor

Graduation en grades - Grades scales

1/2 circulaire - 1/2 circle : Ø25 cm

Circulaire - Circular : Ø20 cm

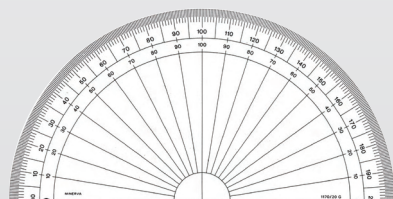

MODÈLE MODEL	REF.	CARACTÉRISTIQUES SPECIFICATIONS	CONDITIONNEMENT PACKING	UV/PCB
n° 1169/25G Ø25 cm	M79352460*	Altuglas® phot gravé Photographed Altuglas®		Vrac / Bulk 1/10

* Jusqu'à épuisement des stocks









TRACE-LETTRES NORME ISO

ISO lettering guides

Caractères normalisés -Standard characters : NF-EN 3098-1

Caractères droits : majuscules, minuscules et chiffres -Straight letters, capitals, lowercase figures



Bords amovibles permettant d'écrire à l'encre et au crayon - Removable edges allowing ink and pencil writing

MODÈLE MODEL	REF.	CARACTÉRISTIQUES SPECIFICATIONS	CONDITIONNEMENT PACKING	UV/PCB
ISO 2,5 DROIT Lettres 2,5 mm	M79352401	Altuglas® phot gravé Photograved Altuglas®		Vrac / Bulk 1/10
ISO 3,5 DROIT Lettres 3.5 mm	M79352402	Altuglas® phot gravé Photograved Altuglas®		Vrac / Bulk 1/10
ISO 5 DROIT Lettres 5 mm	M79352404	Altuglas® phot gravé Photograved Altuglas®		Vrac / Bulk 1/10
ISO 7 DROIT Lettres 7 mm	M79352405	Altuglas® phot gravé Photograved Altuglas®		Vrac / Bulk 1/10

BILLOGRAPHE

Caractères droits : majuscules, minuscules et chiffres -Straight letters, capitals, lowercase figures

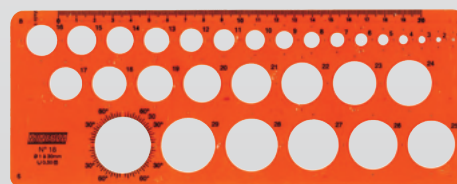
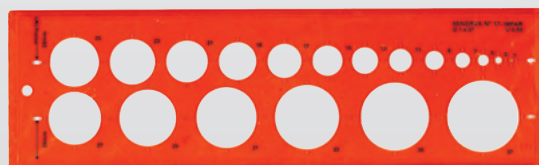

Pour stylo à bille ou roller -Specialy designed for ball and roller pens

MODÈLE MODEL	REF.	CARACTÉRISTIQUES SPECIFICATIONS	CONDITIONNEMENT PACKING	UV/PCB
BILLO 6 Lettres 6 mm	M79352424	Altuglas® phot gravé Photograved Altuglas®		Vrac / Bulk 1/10
BILLO 8 Lettres 8 mm	M79352425	Altuglas® phot gravé Photograved Altuglas®		Vrac / Bulk 1/10
BILLO 10 Lettres 10 mm	M79352426	Altuglas® phot gravé Photograved Altuglas®		Vrac / Bulk 1/10



TRACE ELLIPSES

Ellipse guides

MODÈLE MODEL	REF.	CARACTÉRISTIQUES SPECIFICATIONS	CONDITIONNEMENT PACKING	UV/PCB
n°44/30°	M79352416	Acétate de cellulose AC/CA		Vrac / Bulk 1/20
n°44/45°	M79352417	Acétate de cellulose AC/CA		Vrac / Bulk 1/20

TRACE CERCLES

Circles guides

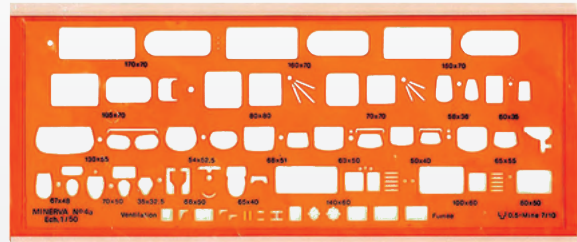
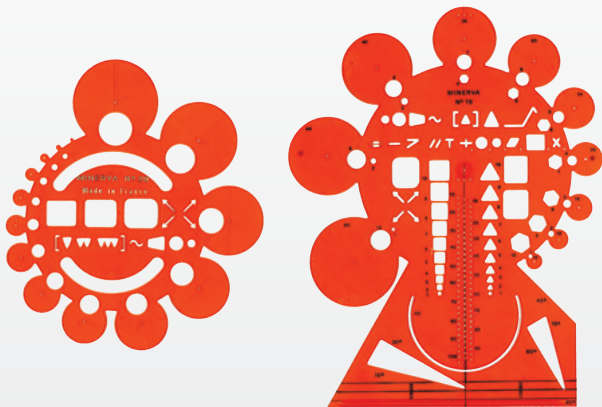

MODÈLE MODEL	REF.	CARACTÉRISTIQUES SPECIFICATIONS	CONDITIONNEMENT PACKING	UV/PCB
n°17	M79352408	Acétate de cellulose AC/CA		Vrac / Bulk 1/10
n°17A	M79352409	Acétate de cellulose AC/CA		Vrac / Bulk 1/20
n°18	M79352410	Acétate de cellulose AC/CA		Vrac / Bulk 1/20

* Jusqu'à épaisseur des stocks



TRACE CIRCONFÉRENCES



Circumferences guides

MODÈLE MODEL	REF.	CARACTÉRISTIQUES SPECIFICATIONS	CONDITIONNEMENT PACKING	LIV/PCB
n° 19	M79352446*	Acétate de cellulose AC/CA 	Vrac / Bulk	1/10
n°20	M79352447*	Acétate de cellulose AC/CA 	Vrac / Bulk	1/10

* Jusqu'à épuisement des stocks

TRACE SANITAIRES

Sanitarian guides

MODÈLE MODEL	REF.	CARACTÉRISTIQUES SPECIFICATIONS	CONDITIONNEMENT PACKING	LIV/PCB
n°4a Echelle 1/50	M79352403	Acétate de cellulose AC/CA 	Vrac / Bulk	1/10
n°5a Echelle 1/100	M79352444*	Acétate de cellulose AC/CA 	Vrac / Bulk	1/10

* Jusqu'à épuisement des stocks



TRACE ÉCROUS

Nuts guide

Écrous - Nuts : Ø 2 à 18 mm
Circonférences - Circumferences : Ø 4 à 44 mm

MODÈLE MODEL	REF.	CARACTÉRISTIQUES SPECIFICATIONS	CONDITIONNEMENT PACKING	LIV/PCB
n°2	M79352400	Acétate de cellulose AC/CA 	Vrac / Bulk	1/10

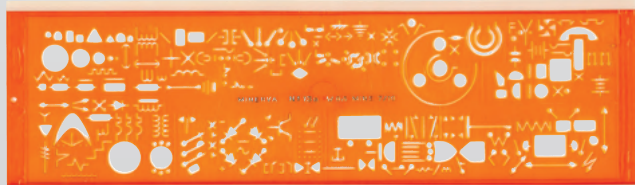
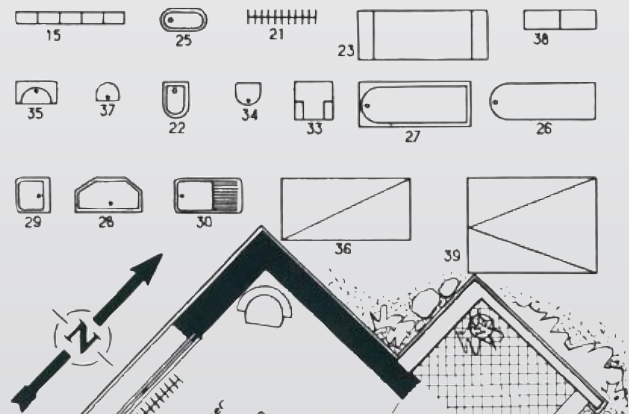

ÉLECTROGRAPHE

Electrographer

Trace-symboles électriques, électroniques, logiques, téléphoniques -
Electrical, electronical, logical, telephon guides
Bords amovibles - Removable edges

MODÈLE MODEL	REF.	CARACTÉRISTIQUES SPECIFICATIONS	CONDITIONNEMENT PACKING	LIV/PCB
n°13a	M79352407	Acétate de cellulose AC/CA 	Vrac / Bulk	1/10

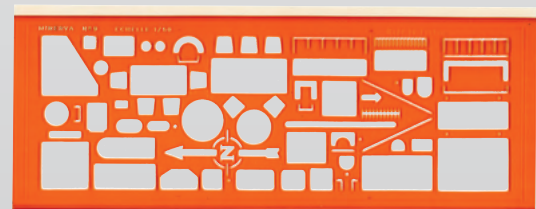

ARCHITECTOGRAPHES

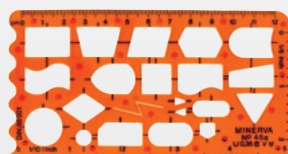
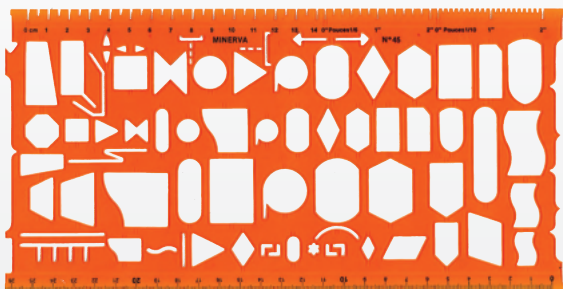

Architectographers

MODÈLE MODEL	REF.	CARACTÉRISTIQUES SPECIFICATIONS	CONDITIONNEMENT PACKING	LIV/PCB
n°9 Echelle 1/50	M79352406	Acétate de cellulose AC/CA 	Vrac / Bulk	1/10



ORGANIGRAPHERS

Organizational charts guides

MODÈLE MODEL	REF.	CARACTÉRISTIQUES SPECIFICATIONS	CONDITIONNEMENT PACKING	LIV/PCB
n°45 4/4 5/5	M79352412	Acétate de cellulose AC/CA 	Vrac / Bulk	1/10
n°45a	M79352439*	Acétate de cellulose AC/CA 	Vrac / Bulk	1/20

* Jusqu'à épuisement des stocks



RADIOGRAPHE

Radiographer guide

MODÈLE MODEL	REF.	CARACTÉRISTIQUES SPECIFICATIONS	CONDITIONNEMENT PACKING	LIV/PCB
n°36	M79352448*	Acétate de cellulose AC/CA 	Vrac / Bulk	1/10

* Jusqu'à épuisement des stocks



CODE DE LA ROUTE

Traffic laws guide

MODÈLE MODEL	REF.	CARACTÉRISTIQUES SPECIFICATIONS	CONDITIONNEMENT PACKING	LIV/PCB
n°52	M79352451*	Acétate de cellulose AC/CA 	Vrac / Bulk	1/10

* Jusqu'à épuisement des stocks



SYMBOLES TACTIQUES

Tactical symbols guide

Série complémentaire (carrés, ronds, triangles, hexagones) de différentes tailles
- Complementary series (squares, circles, triangles, hexagons) of different sizes

MODÈLE MODEL	REF.	CARACTÉRISTIQUES SPECIFICATIONS	CONDITIONNEMENT PACKING	LIV/PCB
OTAN n°46	M79352413	Acétate de cellulose AC/CA 	Vrac / Bulk	1/10



HYDROPNEUMATIQUE

Hypneumatic guide

MODÈLE MODEL	REF.	CARACTÉRISTIQUES SPECIFICATIONS	CONDITIONNEMENT PACKING	LIV/PCB
n°38	M79352450*	Acétate de cellulose AC/CA 	Vrac / Bulk	1/10

* Jusqu'à épuisement des stocks



LOGIQUE

Logical guide

MODÈLE MODEL	REF.	CARACTÉRISTIQUES SPECIFICATIONS	CONDITIONNEMENT PACKING	LIV/PCB
n°37	M79352449*	Acétate de cellulose AC/CA 	Vrac / Bulk	1/10

* Jusqu'à épuisement des stocks



MINER-MATH

MODÈLE MODEL	REF.	CARACTÉRISTIQUES SPECIFICATIONS	CONDITIONNEMENT PACKING	LIV/PCB
n°55	M79352452*	Acétate de cellulose AC/CA 	Vrac / Bulk	1/0

* Jusqu'à épuisement des stocks

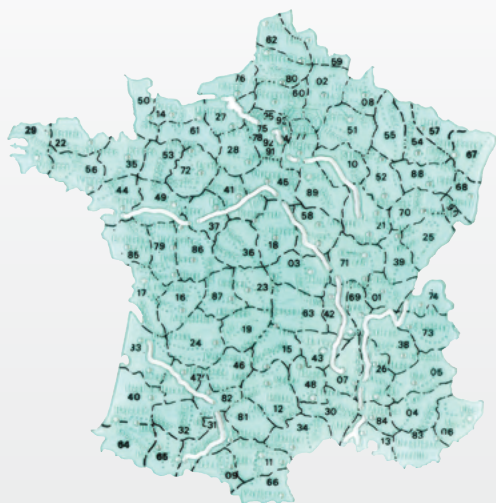

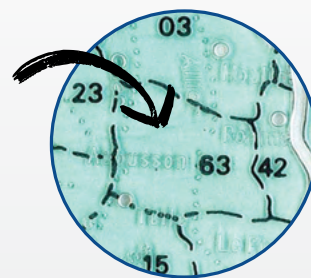

**ET LÀ,
C'EST NOUS !**



CARTE DE FRANCE France map



Départements et chefs-lieux - Counties and chieftowns

MODÈLE MODEL	REF.	CARACTÉRISTIQUES SPECIFICATIONS	CONDITIONNEMENT PACKING	LIV/PCB
n°12	M79352454	Acétate de cellulose AC/CA  	Vrac / Bulk	1/20



CARTE D'EUROPE Europe map

Carte contour Europe sans frontières - Europe outline, borderless



MODÈLE MODEL	REF.	CARACTÉRISTIQUES SPECIFICATIONS	CONDITIONNEMENT PACKING	LIV/PCB
n°13	M79352441*	Acétate de cellulose AC/CA  	Vrac / Bulk	1/20

* Jusqu'à épaisseur des stocks



CARTE D'AFRIQUE Africa map

Pays et fleuves - Country and rivers



MODÈLE MODEL	REF.	CARACTÉRISTIQUES SPECIFICATIONS	CONDITIONNEMENT PACKING	LIV/PCB
n°16	M79352457*	Acétate de cellulose AC/CA  	Vrac / Bulk	1/20

* Jusqu'à épaisseur des stocks



CARTE D'AMÉRIQUE DU NORD North america map

Pays et lacs - Country and lakes



MODÈLE MODEL	REF.	CARACTÉRISTIQUES SPECIFICATIONS	CONDITIONNEMENT PACKING	LIV/PCB
n°14	M79352455*	Acétate de cellulose AC/CA  	Vrac / Bulk	1/20

* Jusqu'à épaisseur des stocks



CARTE D'AMÉRIQUE DU SUD South america map

Pays et fleuves - Country and rivers

MODÈLE MODEL	REF.	CARACTÉRISTIQUES SPECIFICATIONS	CONDITIONNEMENT PACKING	LIV/PCB
n°15	M79352456*	Acétate de cellulose AC/CA  	Vrac / Bulk	1/20

* Jusqu'à épaisseur des stocks



CALCULATRICES / CALCULATORS



Pliable



Foldable



BALANCE ÉLECTRONIQUE ET CALCULATRICE E102 E102 Foldable digital electronic scale with calculator

Calculatrice - Calculator :

- Affichage 12 chiffres - 12 digits display
- Solaire + piles (incluses) - Solar + battery (included)
- Arrêt automatique - Automatic switch-off
- Touches en silicone - Plastic keys
- Touches mémoire - Independant memory

Balance - Scale :

- Plateau en acier inoxydable - Stainless steel pan
- Piles (incluses) - Battery (included)
- Arrêt automatique - Automatic switch-off
- 6 unités de mesure : gn (grain) / oz (once) / ozt (troy ounce) / dwt (denier) / ct (carat) / g (gramme) - 6 differents units : gn (grain) / oz (ounce) / ozt (troy ounce) / dwt (pennyweight) / ct (carat) / g (gram)
- Capacité maximum de la balance : 1100g - 38,8oz - 35,365ozt - 16975,59gn - 707,316dwt - Maximum capacity of scale : 1100g - 38,8oz - 35,365ozt - 16975,59gn - 707,316dwt
- Précision : 0,1g - Precision : 0,1g

REF.	DIMENSIONS	CARACTÉRISTIQUES SPECIFICATIONS	CONDITIONNEMENT PACKING	LIV/PCB
E102	163 x 78 x 16 mm	12 chiffres 12 digits	 Boîte / Box	1/25



CALCULATRICES DE POCHE 283-8 283-8 pocket calculators

Affichage 8 chiffres - 8 digits display

Piles incluses - Batteries included

Arrêt automatique - Automatic switch-off

Touches caoutchouc - Rubber keys

Touches mémoire - Independant memory

Calcul de racine - Square root

283-8G et 283-8W : + housse de protection - + protective cover

REF.	DIMENSIONS	CARACTÉRISTIQUES SPECIFICATIONS	CONDITIONNEMENT PACKING	LIV/PCB
283-8	69 x 9 x 118 mm	8 chiffres 8 digits	 LS / Pegboardable	1/200
283-8B*	69 x 9 x 118 mm	8 chiffres 8 digits	 LS / Pegboardable	1/200
283-8C*	69 x 9 x 118 mm	8 chiffres 8 digits	 LS / Pegboardable	1/200
283-8W*	69 x 9 x 118 mm	8 chiffres 8 digits	 LS / Pegboardable	1/200

* Jusqu'à épuisement des stocks



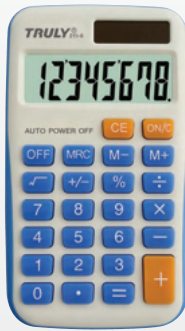

CALCULATRICE DE POCHE 215-8 215-8 pocket calculators

Affichage 8 chiffres - 8 digits display
Solaire + pile / Arrêt automatique - Solar + battery / Automatic switch-off
Touches caoutchouc - Rubber keys
Touches mémoire - Independent memory
Calcul de racine - Square root

REF.	DIMENSIONS	CARACTÉRISTIQUES SPECIFICATIONS	CONDITIONNEMENT PACKING	LIV/PCB
215-8*	68 x 10 x 119 mm	8 chiffres 8 digits 	LS / Pegboardable	1/200

CALCULATRICE DE POCHE 216-8 216-8 pocket calculator

Affichage 8 chiffres - 8 digits display
Solaire + pile / Arrêt automatique - Solar + battery / Automatic switch-off
Touches caoutchouc - Rubber keys
Touches mémoire - Independent memory
Calcul de racine - Square root
Calcul de pourcentages - Percentages calculation

REF.	DIMENSIONS	CARACTÉRISTIQUES SPECIFICATIONS	CONDITIONNEMENT PACKING	LIV/PCB
216-8	65 x 9 x 111 mm	8 chiffres 8 digits 	LS / Pegboardable	1/200



CALCULATRICE DE POCHE 216-10 216-10 pocket calculator

Affichage 10 chiffres - 10 digits display
Solaire + pile / Arrêt automatique - Solar + battery / Automatic switch-off
Touches caoutchouc - Rubber keys
Touches mémoire - Independent memory
Calcul de racine - Square root
Calcul de pourcentages - Percentages calculation
+ housse de protection - Protective cover

REF.	DIMENSIONS	CARACTÉRISTIQUES SPECIFICATIONS	CONDITIONNEMENT PACKING	LIV/PCB
216-10	65 x 9 x 111 mm	10 chiffres 10 digits 	LS / Pegboardable	1/200

CALCULATRICE DE POCHE 285 285 pocket calculator

Affichage 10 chiffres - 10 digits display
Solaire + pile / Arrêt automatique - Solar + battery / Automatic switch-off
Touches plastique - Plastic keys
Touches mémoire - Independent memory
Calcul de marges et taxes - Markup and taxes calculation

REF.	DIMENSIONS	CARACTÉRISTIQUES SPECIFICATIONS	CONDITIONNEMENT PACKING	LIV/PCB
285	70 x 10 x 118 mm	10 chiffres 10 digits	LS / Pegboardable	1/200



CALCULATRICE DE POCHE 289-8 289-8 pocket calculator

Affichage 8 chiffres - 8 digits display
Solaire + pile / Arrêt automatique - Solar + battery / Automatic switch-off
Touches caoutchouc - Rubber keys
Touches mémoire - Independant memory
Couvercle rotatif à 360° - Rotative hand cover 360°

REF.	DIMENSIONS	CARACTÉRISTIQUES SPECIFICATIONS	CONDITIONNEMENT PACKING	LIV/PCB
289-8*	67 x 11.5 x 118 mm	8 chiffres 8 digits 	LS / Pegboardable	1/200

* Jusqu'à épuisement des stocks

CALCULATRICE DE BUREAU 662-12 662-12 Desktop calculator

Affichage 12 chiffres - 12 digits display
Solaire + pile / Arrêt automatique - Solar + battery / Automatic switch-off
Touches plastique - Plastic keys
Touches mémoire - Independant memory
Calcul de marges, racine et % - Markup, square root and % calculation
Touche 00 - 00 key
Correction rapide - Shift back key
Grand écran incliné - Large slant screen

REF.	DIMENSIONS	CARACTÉRISTIQUES SPECIFICATIONS	CONDITIONNEMENT PACKING	LIV/PCB
662-12	110 x 16 x 173 mm	12 chiffres 12 digits 	LS / Pegboardable	1/80



CALCULATRICE DE BUREAU 669 669 Desktop calculator

Affichage 12 chiffres - 12 digits display
Solaire + pile / Arrêt automatique - Solar + battery / Automatic switch-off
Touches plastique - Plastic keys
Touches mémoire - Independant memory
Calcul de taxes - Taxes calculation
Ventes et marges - Cost sells margin
Convertisseur euro - Euro conversion
Écran incliné - Slant screen

REF.	DIMENSIONS	CARACTÉRISTIQUES SPECIFICATIONS	CONDITIONNEMENT PACKING	LIV/PCB
669	112 x 33 x 169 mm	12 chiffres 12 digits 	LS / Pegboardable	1/50

CALCULATRICE DE BUREAU 806B-8 806B-8 Desktop calculator

Affichage 8 chiffres - 8 digits display
Solaire + pile / Arrêt automatique - Solar + battery / Automatic switch-off
Touches plastique - Plastic keys
Touches mémoire - Independant memory
Calcul de racine - Square root
Écran incliné - Slant screen

REF.	DIMENSIONS	CARACTÉRISTIQUES SPECIFICATIONS	CONDITIONNEMENT PACKING	LIV/PCB
806B-8	89 x 22 x 127 mm	8 chiffres 8 digits 	LS / Pegboardable	1/100



CALCULATRICE DE BUREAU 812A-12 812A-12 Desktop calculator

Affichage 12 chiffres - 12 digits display
Solaire + pile / Arrêt automatique - Solar + battery / Automatic switch-off
Touches plastique - Plastic keys
Touches mémoire - Independent memory
Calcul de marges - Markup calculation
Calcul de racine - Square root
Écran incliné - Slant screen

REF.	DIMENSIONS	CARACTÉRISTIQUES SPECIFICATIONS	CONDITIONNEMENT PACKING	LIV/PCB
812A-12	112 x 40 x 169 mm	12 chiffres 12 digits	LS / Pegboardable	1/50



CALCULATRICE DE BUREAU 836B-10 836-10 Desktop calculator

Affichage 10 chiffres - 10 digits display
Solaire + pile / Arrêt automatique - Solar + battery / Automatic switch-off
Touches plastique - Plastic keys
Touches mémoire - Independent memory
Calcul de marge - Markup calculation
Calcul de racine - Square root
Écran incliné - Slant screen

REF.	DIMENSIONS	CARACTÉRISTIQUES SPECIFICATIONS	CONDITIONNEMENT PACKING	LIV/PCB
836B-10	93 x 39 x 127 mm	10 chiffres 10 digits	LS / Pegboardable	1/80



CALCULATRICE DE BUREAU 866T-12 866T-12 Desktop calculators

Affichage 12 chiffres - 12 digits display
Solaire + pile / Arrêt automatique - Solar + battery / Automatic switch-off
Touches plastique - Plastic keys
Touches mémoire - Independent memory
Calcul de marges et taxes - Markup and taxes calculation
Écran incliné - Slant screen

REF.	DIMENSIONS	CARACTÉRISTIQUES SPECIFICATIONS	CONDITIONNEMENT PACKING	LIV/PCB
866T-12	89.5 x 25 x 129 mm	12 chiffres 12 digits	LS / Pegboardable	1/80



CALCULATRICE DE BUREAU 920 920 Desktop calculator

Affichage 12 chiffres - 12 digits display
Solaire + pile / Arrêt automatique - Solar + battery / Automatic switch-off
Touches plastique - Plastic keys
Touches mémoire - Independent memory
Calcul de taxes - Taxes calculation
Ventes et marges - Cost sells margin
Écran incliné - Slant screen

REF.	DIMENSIONS	CARACTÉRISTIQUES SPECIFICATIONS	CONDITIONNEMENT PACKING	LIV/PCB
920	130 x 39 x 178 mm	12 chiffres 12 digits	LS / Pegboardable	1/40

THERMOMÈTRES / THERMOMETERS

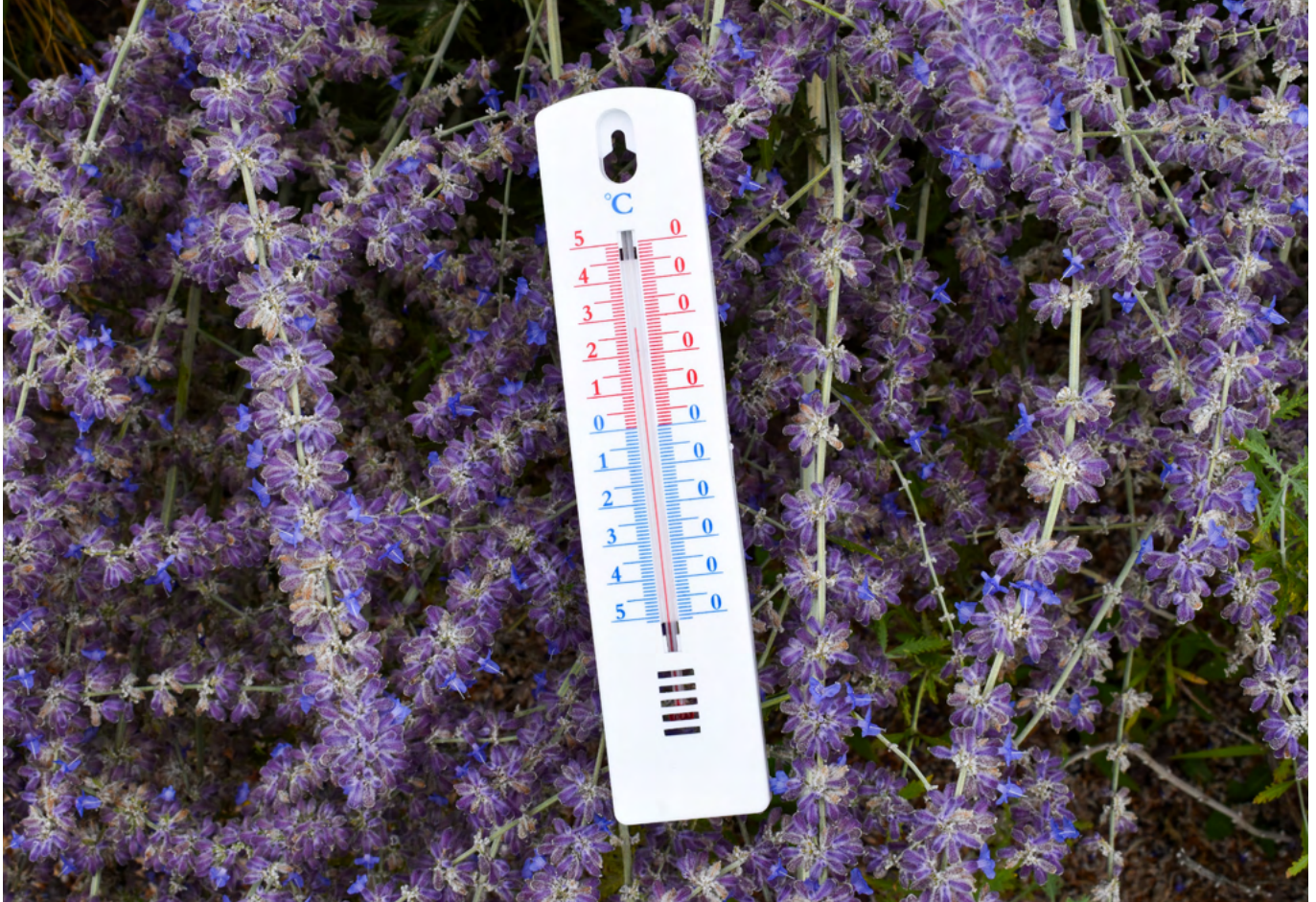

**ÇA VA
CHAUFFER !**

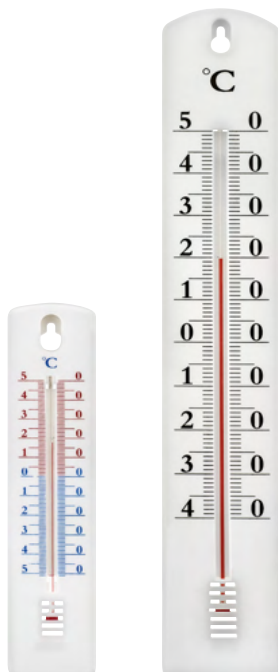

THERMOMÈTRES
Thermometers

Pour usages intérieur et extérieur - *For indoor and outdoor use*
 Thermomètres plastique - *Plastic thermometers*
 Tube en verre protégé - (kérosène) - *Kerosene-filled protected glass tube*
 T° en degrés Celsius - *T° in Celsius degrees*

REF.	DIMENSIONS	CARACTÉRISTIQUES SPECIFICATIONS	CONDITIONNEMENT PACKING	UV/PCB
FIM000062	195 x 42 mm		LS Pegboardable	12/288
FIM000162	395 x 62 mm		LS Pegboardable	6/144

ACTIVITÉS SCOLAIRES

School activities

Pour les globes et les cartes murales la cartographie est en français.
Ces produits sont uniquement vendus dans les pays francophones
For the globes and wall maps the cartography is in French.
These products are only sold in French speaking countries.

GLOBES / GLOBES







GLOBES Ø 40 CM « FORTY »

Globe lumineux avec loupe
Pied bois et méridien plastique

Sphère bleue
Double cartographie : Physique / Politique

Sphère antique

REF.	DIMENSIONS	CARACTÉRISTIQUES SPECIFICATIONS	CONDITIONNEMENT PACKING	LIV/PCB
FOP551263	Ø 40 cm	 	Boîte / Box	1/1
FOP551363 Antique	Ø 40 cm	 	Boîte / Box	1/1









GLOBES Ø 30 CM « PREMIUM »

Globe lumineux
Pied bois et méridien métal

Sphère bleue et sphère bleue en relief
Double cartographie : Physique / Politique

Sphère antique

REF.	DIMENSIONS	CARACTÉRISTIQUES SPECIFICATIONS	CONDITIONNEMENT PACKING	LIV/PCB
FOP550963	Ø 30 cm	 	Boîte / Box	1/6
FOP551063 Relief	Ø 30 cm	 	Boîte / Box	1/6
FOP551163 Antique	Ø 30 cm	 	Boîte / Box	1/6









GLOBES Ø 30 CM « MEDIUM »

Globe lumineux
Pied bois et méridien plastique

Sphère bleue et sphère bleue en relief
Double cartographie : Physique / Politique

Sphère antique

REF.	DIMENSIONS	CARACTÉRISTIQUES SPECIFICATIONS	CONDITIONNEMENT PACKING	LIV/PCB
FOP550663	Ø 30 cm	 	Boîte / Box	1/6
FOP550763 Relief	Ø 30 cm	 	Boîte / Box	1/6
FOP550863 Antique	Ø 30 cm	 	Boîte / Box	1/6





GLOBES Ø 30 CM « FIRST »

Globe lumineux
Pied et méridien plastique

Sphère bleue et sphère bleue en relief
Double cartographie : Physique / Politique



Sphère antique

REF.	DIMENSIONS	CARACTÉRISTIQUES SPECIFICATIONS	CONDITIONNEMENT PACKING	LIV/PCB
FOP550363	Ø 30 cm		Boîte / Box	1/6
FOP550463 Relief	Ø 30 cm		Boîte / Box	1/6
FOP550563 Antique	Ø 30 cm		Boîte / Box	1/6



GLOBE Ø 30 CM « GLOBE'N'KIT »

Sphère bleue
Globe lumineux avec double cartographie :
- Eteint : physique et courants marins
- Allumé : politique
Pied et méridien plastique
Livré en kit avec une notice de montage
Facilité de stockage
Montage simple en moins de 2 minutes



REF.	DIMENSIONS	CARACTÉRISTIQUES SPECIFICATIONS	CONDITIONNEMENT PACKING	LIV/PCB
FOP551463	Ø 30 cm		Boîte / Box	1/4

ACTIVITÉS SCOLAIRES

School activities



GLOBE Ø 25 CM « BASIC »

Sphère bleue
Globe lumineux avec double cartographie : Physique / Politique
Pied et méridien plastique

REF.	DIMENSIONS	CARACTÉRISTIQUES SPECIFICATIONS	CONDITIONNEMENT PACKING	LIV/PCB
FOP50263	Ø 25 cm	 	Boîte / Box	1/6



GLOBE Ø 30 CM





Globe terrestre bleu
Base et méridien en plastique
Cartographie politique

REF.	DIMENSIONS	CARACTÉRISTIQUES SPECIFICATIONS	CONDITIONNEMENT PACKING	LIV/PCB
FOP500563	Ø 30 cm	 	Boîte / Box	1/6



GLOBES Ø 25 CM « KIDS »

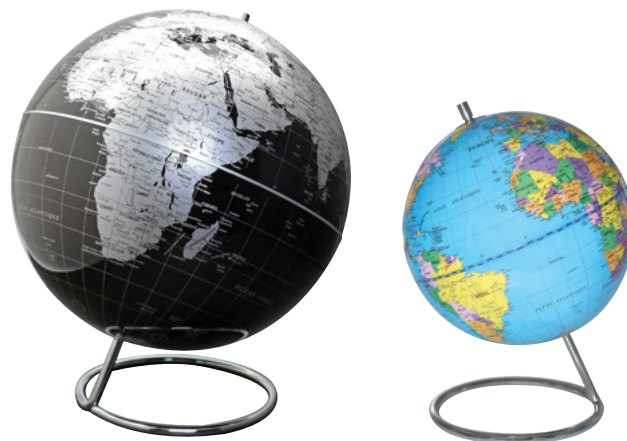

Sphère bleue ou rose
Globe lumineux
Cartographie simplifiée et illustrée avec de nombreux dessins représentant les populations, les monuments, la faune et la flore sur les différents continents et océans
Pied et méridien plastique

REF.	DIMENSIONS	CARACTÉRISTIQUES SPECIFICATIONS	CONDITIONNEMENT PACKING	LIV/PCB
FOP50063	Ø 25 cm	 	Boîte / Box	1/6
FOP50163	Ø 25 cm	 	Boîte / Box	1/6



GLOBES « DESIGN » Ø 32 ET 20 CM

Globe plastique
Support en métal chromé
Cartographie politique

REF.	DIMENSIONS	CARACTÉRISTIQUES SPECIFICATIONS	CONDITIONNEMENT PACKING	LIV/PCB
FOP500463*	Ø 32 cm		Boîte / Box	1/2
FOP500363*	Ø 20 cm		Boîte / Box	1/6
FOP500263*	Ø 20 cm		Boîte / Box	1/6

* Jusqu'à épuisement des stocks

LOUPES / MAGNIFIERS



LOUPES VERRE OPTIQUE Optical glass magnifiers

Lentilles en verre optique - Optical glass lens
Grossissement x 3 - Magnification x 3
Monture métal chromé - Chrome-plated metal frame
Manche plastique - Plastic handle

REF.	DIM. (Ø MM)	CARACTÉRISTIQUES SPECIFICATIONS	CONDITIONNEMENT PACKING	UV/PCB
FLO100472	Ø 50 mm	Verre-Métal Glass-Metal		LS / Pegboardable 1/144
FLO100572	Ø 60 mm	Verre-Métal Glass-Metal		LS / Pegboardable 1/144
FLO100672	Ø 75 mm	Verre-Métal Glass-Metal		LS / Pegboardable 1/96
FLO100772	Ø 90 mm	Verre-Métal Glass-Metal		LS / Pegboardable 1/72



LOUPES «CONFORT» «Comfort» magnifiers

Grossissement x 3 - Magnification x 3
Verre acrylique optique cerclé de plastique - Plastic framed optical acrylic glass
Manche bi-matière - Bi-material handle

REF.	DIM.	CARACTÉRISTIQUES SPECIFICATIONS	CONDITIONNEMENT PACKING	UV/PCB
FLO100082	Ø 75 mm	Verre-PP-TPR Glass-PP-TPR		LS / Pegboardable 10/100
FLO100102	Ø 75 mm	Verre-PP-TPR Glass-PP-TPR		LS / Pegboardable 10/100



LOUPES ACRYLIQUE Acrylic magnifiers

Verre acrylique optique - Optical acrylic glass
Grossissement x 4 - Magnification x 4
FLO100302 : lentille bifocale - bifocal lens

REF.	DIM.	CARACTÉRISTIQUES SPECIFICATIONS	CONDITIONNEMENT PACKING	UV/PCB
FLO100202	Ø 45 mm	Verre-Acrylique Glass-Acrylic		LS / Pegboardable 12/144
FLO100302	Ø 60 mm	Verre-Acrylique Glass-Acrylic		LS / Pegboardable 12/144

ACTIVITÉS SCOLAIRES

School activities

BOUSSOLES / COMPASSES

BOUSSOLES DE POCHE Pocket-size compasses



Support sur aiguille - Support on needle

REF.	DIM.	CARACTÉRISTIQUES SPECIFICATIONS	CONDITIONNEMENT PACKING	LV/PCB
FOP000062*	Ø 35 mm	Plastique Plastic		LS / Pegboardable 12/144

* Jusqu'à épuisement des stocks



BOUSSOLE DE RANDONNÉE Hiking compasses

Boîtier rigide avec couvercle - Rigid box with cap
Amortie par huile - Oil-damped
Lentille et fente de repère - Mark lens and window inside cap
Boucle d'attache - Hanging ring
Livrée avec notice et cordon - Delivered with explanatory leaflet and cord

REF.	DIM.	CARACTÉRISTIQUES SPECIFICATIONS	CONDITIONNEMENT PACKING	LV/PCB
FOP000361	Ø 54 mm	Plastique Plastic		Vrac / Bulk 1/144



Couvercle et boucle d'attache - With cap and hanging ring

REF.	DIM.	CARACTÉRISTIQUES SPECIFICATIONS	CONDITIONNEMENT PACKING	LV/PCB
FOP000162	Ø 45 mm	Plastique Plastic		LS / Pegboardable 12/144

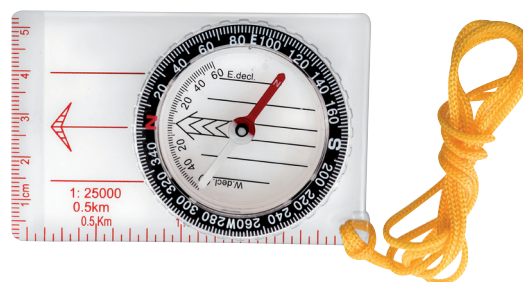

BOUSSOLES D'ORIENTATION Orienteering compasses

Plastique anti-choc - Shock-proof plastic
Amortie par huile - Oil-damped
Livrée avec notice et cordon - Delivered with explanatory leaflet and cord
Echelles de réduction imprimées, repère de direction - Printed reduction scales, direction landmarks
170141 : + loupe - + magnifiers

Cordon de suspension - Hanging cord

REF.	DIM.	CARACTÉRISTIQUES SPECIFICATIONS	CONDITIONNEMENT PACKING	LV/PCB
FOP000561*	Ø 55 mm	Plastique Plastic		Boîte / Box 50/400

* Jusqu'à épuisement des stocks

REF.	DIM.	CARACTÉRISTIQUES SPECIFICATIONS	CONDITIONNEMENT PACKING	LV/PCB
FOP000461*	60x85 mm	Plastique Plastic		Boîte / Box 1/144
170141*	60x125 mm	Plastique Plastic		Boîte / Box 1/240

* Jusqu'à épuisement des stocks

GOURDES / BOTTLES



GOURDE ISOTHERME Isothermal bottle



500 ml - 500 ml
Acier inox double paroi - Double-walled stainless steel
Coloris assortis - Assorted colours

REF.	DIMENSIONS	CARACTÉRISTIQUES SPECIFICATIONS	CONDITIONNEMENT PACKING	LIV/PCB
FAS100173	500 ml		Vrac / Bulk	12/24



ÇA COULE DE SOURCE !



GOURDE ALUMINIUM Aluminium bottle

500 ml - 500 ml
Aluminium alimentaire - Food contact aluminium
Design assortis - Assorted designs

REF.	DIMENSIONS	CARACTÉRISTIQUES SPECIFICATIONS	CONDITIONNEMENT PACKING	LIV/PCB
FAS100071	500 ml		Vrac / Bulk	10/30

ACTIVITÉS SCOLAIRES



School activities

ACCESSOIRES SCOLAIRES / SCHOOL ACCESSORIES





JALONS POUR CÔNES PERFORÉS Barrels for cones with holes



REF.	DIMENSIONS	CARACTÉRISTIQUES SPECIFICATIONS	CONDITIONNEMENT PACKING	UV/PCB
JSP900161	Ø 2.5 x 80 cm	PE 	Vrac / Bulk	10/100
JSP900261	Ø 2.5 x 100 cm	PE 	Vrac / Bulk	10/100
JSP900361	Ø 2.5 x 120 cm	PE 	Vrac / Bulk	10/80

CÔNES PERFORÉS Cones with holes

Cônes perforés multi-fonctions, robustes, pouvant être utilisés avec des jalons - Robust, multi-functional perforated cones that can be used with barrel
Permet la création de parcours de motricité et autres activités sportives en collectivités - Allows creation of soft play and team sports activities

REF.	DIMENSIONS	CARACTÉRISTIQUES SPECIFICATIONS	CONDITIONNEMENT PACKING	UV/PCB
JSP300161	30 cm	PE 	Vrac / Bulk	5/60
JSP400161	38 cm	PE 	Vrac / Bulk	5/25
JSP500161	50 cm	PE 	Vrac / Bulk	5/25



PLOTS DE MARQUAGE

Flat cones

Lot de 40 plots de marquage - Set of 40 flat cones
 Ø 19 cm - H 5 cm - Ø 19 cm - H 5 cm
 Coloris assortis - Avec socle - Assorted colours - With stand
 Livrés avec un filet de rangement - Comes with a storage net

REF.	DIMENSIONS	CARACTÉRISTIQUES SPECIFICATIONS	CONDITIONNEMENT PACKING	LIV/PCB
JSP050161	Ø 19 cm	PE	Vrac / Bulk	1/6



CÔNES FLEXIBLES

Flexible cones

Lot de 8 cônes flexibles - Set of 8 flexibles cones
 4 coloris assortis - 4 assorted colours
 Livrés avec un filet de rangement - Comes with a storage net

REF.	DIMENSIONS	CARACTÉRISTIQUES SPECIFICATIONS	CONDITIONNEMENT PACKING	LIV/PCB
JSP180161	18 cm	PE	Vrac / Bulk	1/6
JSP230161	23 cm	PE	Vrac / Bulk	1/6

SIFFLET

Whistle

Corps métal - Metal body
 Bille plastique - Plastic ball
 Avec cordon - With cord



REF.	DIMENSIONS	CARACTÉRISTIQUES SPECIFICATIONS	CONDITIONNEMENT PACKING	LIV/PCB
FOP800071	-		Vrac / Bulk	12/240



SIFFLET À MAIN

Squeeze whistle

Avec bille en liège et cordon - With cork ball and cord

REF.	DIMENSIONS	CARACTÉRISTIQUES SPECIFICATIONS	CONDITIONNEMENT PACKING	LIV/PCB
FOP800562	-		LS / Pegboardable	12/144



CHRONOMÈTRE

Stopwatch

Chronomètre digital non étanche, précis au 1/100ème de seconde - Not waterproof 1/100th second digital stopwatch
 Temps simple, temps au tour/temps intermédiaire - Normal time, split/lap time
 Grand affichage - Large digits
 Fonction horloge, calendrier et alarme - Time, calendar and alarm functions
 Boussole et pile incluses - Compass and cell battery included



MODÈLE MODEL	REF.	CARACTÉRISTIQUES SPECIFICATIONS	CONDITIONNEMENT PACKING	LIV/PCB
Digital	FOP200062		LS / Pegboardable	1/144

ACTIVITÉS SCOLAIRES

School activities



GILET DE SÉCURITÉ ENFANT Child safety jacket

Gilet polyester fluo - Fluorescent polyester safety jacket
Bandes réfléchissantes de visibilité 5 cm - Horizontal safety reflecting strips 5 cm
Taille enfant (3-5 ans) - Children use (3-5 years)
Conforme à la norme EN 1150 - In accordance with european standard EN 1150

REF.	TAILLE SIZE	CARACTÉRISTIQUES SPECIFICATIONS	CONDITIONNEMENT PACKING	LIV/PCB
SEP800022	3 - 5 ans	Polyester 	LS / Pegboardable	1/100



CORNE DE BRUME MANUELLE Manual foghorn

Sans gaz - Gaz free



REF.	DIMENSIONS	CARACTÉRISTIQUES SPECIFICATIONS	CONDITIONNEMENT PACKING	LIV/PCB
FOP800662	-		LS / Pegboardable	1/90

**FAITES UN
MAXIMUM DE
BRUIT !**



FLÛTES Recorders

Matière ABS - ABS material
Mode d'emploi - Instructions for use
Étui de rangement et écouvillon de nettoyage - Individual pouch + cleaning swab

MODÈLE MODEL	REF.	CARACTÉRISTIQUES SPECIFICATIONS	CONDITIONNEMENT PACKING	LIV/PCB
Doigté baroque Baroque Fingering	FOP800462		LS / Pegboardable	10/100
Doigté moderne Modern Fingering	FOP800762		LS / Pegboardable	10/100



PIÈCES ET BILLETS « EURO » « EURO » coins and bank notes

Reproduction de pièces en plastique et de billets euros
Reproduction of plastic euro coins and bank notes
Permet l'apprentissage par le jeu de la monnaie euro
Allows game-based learning of euro currency

REF.	CARACTÉRISTIQUES SPECIFICATIONS	CONDITIONNEMENT PACKING	LIV/PCB
FOP300091	80 pièces + 65 billets Euro Euro 80 coins + 65 notes	Vrac / Bulk	1/20
FOP300191	65 billets Euro 65 Euro notes	Vrac / Bulk	1/20
FOP300291	50 pièces Euro 50 Euro coins	Vrac / Bulk	1/50

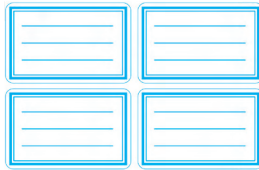

ÉTIQUETTES AUTOCOLLANTES Self-adhesive labels

36 x 56 mm - 36 x 56 mm
Planches de 4 étiquettes - Sheets of 4 labels
Coins arrondis - Rounded corners

REF.	DIMENSIONS	CARACTÉRISTIQUES SPECIFICATIONS	CONDITIONNEMENT PACKING	LIV/PCB
FPP550102 x 24 pcs	36 x 56 mm		LS / Pegboardable	24/480
570012* x 240 pcs	36 x 56 mm		Vrac / Bulk	6/120
FPP550092 x 24 pcs	36 x 56 mm		LS / Pegboardable	24/480

* Jusqu'à épuisement des stocks

240 CÉILLETS DE RENFORCEMENT 240 reinforcing eyelets

ø 14 mm - ø 14 mm
BOPP blanc pour plus de solidité - White perized BOPP
5 feuilles de 48 œillets - 5 sheets of 48 eyelets



REF.	DIMENSIONS	CARACTÉRISTIQUES SPECIFICATIONS	CONDITIONNEMENT PACKING	LIV/PCB
FPP500012	ø 14 mm		LS / Pegboardable	50/600



TAMPONS DE NOTATION "MOOD" "MOOD" teacher stamps

Pré-encreés - Pre-inked
Non rechargeables - Non-refillable

Tampons ø 16 mm - ø 16 mm stamps
Environ 5000 impressions - Around 5,000 prints

Tampons ø 10 mm - ø 10 mm stamps
Environ 4000 impressions - Around 4,000 prints

REF.	DIMENSIONS	CARACTÉRISTIQUES SPECIFICATIONS	CONDITIONNEMENT PACKING	LIV/PCB
FOP600092 x3	ø 16 mm		LS / Pegboardable	12/48
FOP600192 x4	ø 10 mm		LS / Pegboardable	12/48

TROUSSES / PENCIL CASE



TROUSSE RECTANGULAIRE AVEC DOUBLE PLATEAUX Rectangular pencil case with double zipper

En polyester 600D - 600D polyester
Ouverture Velcro® + fermeture zippée - Double tray with Velcro® tape opening + zippers
Filet intérieur + étiquette personnalisable - Inner mesh + nametag label

REF.	DIMENSIONS	CARACTÉRISTIQUES SPECIFICATIONS	CONDITIONNEMENT PACKING	LIV/PCB
FFT500121	23 x 10 x 7 cm		Vrac / Bulk	1/48

ACTIVITÉS SCOLAIRES

School activities



TROUSSE TRIANGLE

Triangle pencil case

En polyester 600D - 600D polyester
 Fermeture zippée - With zipper
 Etiquette personnalisable - Nametag label
 Coloris assortis - Assorted colours

REF.	DIMENSIONS	CARACTÉRISTIQUES SPECIFICATIONS	CONDITIONNEMENT PACKING	LIV/PCB
FFT200121	22.5 x 8.5 x 7.5 cm		Vrac / Bulk	1/48



TROUSSE TRIANGLE

Triangle pencil case

En polyester 600D - 600D polyester
 Fermeture zippée - With zipper
 Etiquette personnalisable - Nametag label

REF.	DIMENSIONS	CARACTÉRISTIQUES SPECIFICATIONS	CONDITIONNEMENT PACKING	LIV/PCB
FFT400021	23.5 x 9.5 x 7.5 cm		Vrac / Bulk	1/48



TROUSSE PLATE

Flat pencil case

En polyester 600D - 600D polyester
 Fermeture zippée - With zipper
 Etiquette personnalisable - Nametag label
 Coloris assortis - Assorted colours

REF.	DIMENSIONS	CARACTÉRISTIQUES SPECIFICATIONS	CONDITIONNEMENT PACKING	LIV/PCB
FFT000221	21.5 x 13 cm		Vrac / Bulk	1/48



TROUSSE PLATE

Flat pencil case

En polyester 420D - 420D polyester
 Fermeture zippée - With zipper
 Coloris assortis - Assorted colours

REF.	DIMENSIONS	CARACTÉRISTIQUES SPECIFICATIONS	CONDITIONNEMENT PACKING	LIV/PCB
FFT000121	22 x 11 cm		Vrac / Bulk	12/144



TROUSSE RECTANGULAIRE AVEC 2 COMPARTIMENTS

Rectangular pencil case with double zipper

Tissu Oxford 600D - Made of 600D Oxford fabric
 Fermeture zippée - With zipper
 Coloris assortis - Assorted colours

REF.	DIMENSIONS	CARACTÉRISTIQUES SPECIFICATIONS	CONDITIONNEMENT PACKING	LIV/PCB
FFT150021	22 x 9 x 6 cm		Vrac / Bulk	12/144



MINI TROUSSES CARRÉES

Mini square pencil cases

Simili cuir - Imitation leather
Fermeture zippée - With zipper

REF.	DIMENSIONS	CARACTÉRISTIQUES SPECIFICATIONS	CONDITIONNEMENT PACKING	LIV/PCB
FFT300101	20 x 3.5 x 3 cm		Vrac / Bulk	24/96
FFT300201*	20 x 3.5 x 3 cm		Vrac / Bulk	24/96
FFT300601	20 x 3.5 x 3 cm		Vrac / Bulk	24/96
FFT300301* Fluo - Neon	20 x 3.5 x 3 cm		Vrac / Bulk	24/96
FFT300401* Fluo - Neon	20 x 3.5 x 3 cm		Vrac / Bulk	24/96
FFT300501* Fluo - Neon	20 x 3.5 x 3 cm		Vrac / Bulk	24/96

* Jusqu'à épuisement des stocks



TROUSSE PLATE FLUO

Flat & neon pencil case

En PVC - PVC
Translucide - Translucent
Fermeture zippée - With zipper
Coloris assortis - Assorted colours

REF.	DIMENSIONS	CARACTÉRISTIQUES SPECIFICATIONS	CONDITIONNEMENT PACKING	LIV/PCB
FFT000061	22 x 11 cm		Vrac / Bulk	12/96



TROUSSE RONDE

Round pencil case

Tissu Oxford - Made of Oxford fabric
Fermeture zippée - With zipper
Coloris assortis - Assorted colours

REF.	DIMENSIONS	CARACTÉRISTIQUES SPECIFICATIONS	CONDITIONNEMENT PACKING	LIV/PCB
FFT200021	Ø 7 x 22 cm		Vrac / Bulk	12/144



R-PET

TROUSSES RONDES

Rounded pencil cases

Tissu 68% R-PET - Made of 68% R-PET fabric
Fermeture zippée - With zipper

REF.	DIMENSIONS	CARACTÉRISTIQUES SPECIFICATIONS	CONDITIONNEMENT PACKING	LIV/PCB
FFT200221	Ø 7,5 x 22 cm	R-PET	Vrac / Bulk	12/144
FFT200321	Ø 7,5 x 22 cm	R-PET	Vrac / Bulk	12/144



ACTIVITÉS SCOLAIRES

School activities

ÉCRITURE / WRITING



SURLIGNEURS Highlighters



Coloris fluo - Neon colours
Pointe biseautée - Bevelled tip
Trait de 1 à 4 mm - 1 to 4 mm width

REF.	QUANTITÉ QUANTITY	CARACTÉRISTIQUES SPECIFICATIONS	CONDITIONNEMENT PACKING	LIV/PCB
FEC400492	x 4		LS Pegboardable	12/144



R-PET



SURLIGNEURS Highlighters

Coloris fluo - Neon colours
Corps & capuchon en R-PET - R-PET body & cap
Pointe biseautée - Bevelled tip
Trait de 1 à 4 mm - 1 to 4 mm width

REF.	QUANTITÉ QUANTITY	CARACTÉRISTIQUES SPECIFICATIONS	CONDITIONNEMENT PACKING	LIV/PCB
FEC400403	x 10	R-PET	Vrac / Bulk	10/240
FEC400503	x 10	R-PET	Vrac / Bulk	10/240
FEC400603	x 10	R-PET	Vrac / Bulk	10/240
FEC400703	x 10	R-PET	Vrac / Bulk	10/240
FEC400192	x 4	R-PET	LS Pegboardable	12/72

SURLIGNEURS Highlighters



Coloris fluo - Neon colours
Corps bi-matière - Bi-material body
Pointe large biseautée - Large bevelled tip
Trait de 2 à 5 mm - 2 to 5 mm width

REF.	QUANTITÉ QUANTITY	CARACTÉRISTIQUES SPECIFICATIONS	CONDITIONNEMENT PACKING	LIV/PCB
FEC410003	-		Vrac / Bulk	10/240
FEC410103	-		Vrac / Bulk	10/240
FEC410203	-		Vrac / Bulk	10/240
FEC410303	-		Vrac / Bulk	10/240
FEC410503	-		Vrac / Bulk	10/240
FEC410492	x 4		LS Pegboardable	12/144

De la bouteille au surligneur...

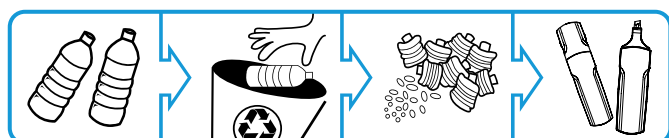

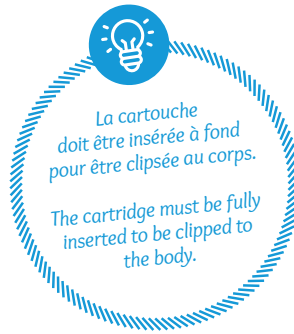

STYLO-PLUME Fountain pen

133 mm

Pointe métal - Metal nib

Corps en PP - Body made in PP

+1 cartouche courte d'encre bleue effaçable - +1 short erasable blue ink cartridge included



STYLO-ROLLER À CARTOUCHE D'ENCRE STANDARD Roller ball pen with standard ink cartridge

133 mm

Pointe métal - Metal nib

Corps en ABS - Body made in ABS

+1 cartouche courte d'encre bleue effaçable - +1 short erasable blue ink cartridge included



REF.	DIMENSIONS	CARACTÉRISTIQUES SPECIFICATIONS	CONDITIONNEMENT PACKING	LIV/PCB
FEC200061	133 mm		Vrac / Bulk	36/432

REF.	DIMENSIONS	CARACTÉRISTIQUES SPECIFICATIONS	CONDITIONNEMENT PACKING	LIV/PCB
FEC210063	133 mm		Vrac / Bulk	36/432



**RETROUVEZ NOTRE
EFFACEUR PAGE 70**



ESSUIE-PLUME MICROFIBRE Microfiber blotter sheets

3 couches assemblées avec rivet - 3 layers assembled with rivet

REF.	DIMENSIONS	CARACTÉRISTIQUES SPECIFICATIONS	CONDITIONNEMENT PACKING	LIV/PCB
FEC900622*	Ø 8 cm		LS / Pegboardable	20/200

* Jusqu'à épuisement des stocks



CARTOUCHES D'ENCRE Ink cartridges

Cartouches courtes standard - Short standard cartridges

FEC300002 : Encre effaçable bleue - Blue erasable ink

FEC300202 : Encre noire - Black ink



REF.	DIMENSIONS	CARACTÉRISTIQUES SPECIFICATIONS	CONDITIONNEMENT PACKING	LIV/PCB
FEC300002 30 pcs	Standard		LS / Pegboardable	12/240
FEC300202 30 pcs	Standard		LS / Pegboardable	12/240

ACTIVITÉS SCOLAIRES

School activities



PORTE-MINES « ÉCO » «Eco» mechanical pencils

Corps plastique - Plastic body
Embout gomme - Eraser tip
Clip d'attache plastique - With plastic clip

MODÈLE MODEL	REF.	CARACTÉRISTIQUES SPECIFICATIONS	CONDITIONNEMENT PACKING	UV/PCB
HB 0.5mm x 10	FEC050062		LS / Pegboardable	12/144
HB 0.7mm x 10	FEC070062		LS / Pegboardable	12/144



**RETROUVEZ
NOS GOMMES
PAGE 71**

ELAMI



PORTE-MINES « INNOVATIVE » « Innovative » mechanical pencils

Corps plastique avec grip antiglisse - Plastic body with soft rubber grip
Embout gomme protégé - Protected eraser tip
Amortisseur de mine - Damper lead
Clip d'attache plastique - With plastic clip

MODÈLE MODEL	REF.	CARACTÉRISTIQUES SPECIFICATIONS	CONDITIONNEMENT PACKING	UV/PCB
HB 0.5 mm	900449		Vrac / Bulk	12/1200
HB 0.7 mm	900450		Vrac / Bulk	12/1200

PORTE-MINES « PRO » « Pro » mechanical pencils

Corps plastique et métal avec grip antiglisse - Plastic and metal body with soft rubber grip
Embout gomme protégé - Protected eraser tip
Amortisseur de mine - Damper
Clip d'attache métal - With metal clip

MODÈLE MODEL	REF.	CARACTÉRISTIQUES SPECIFICATIONS	CONDITIONNEMENT PACKING	UV/PCB
HB 0.5 mm	900451		Vrac / Bulk	12/1200
HB 0.7 mm	900452		Vrac / Bulk	12/1200
HB 0.9 mm	900453		Vrac / Bulk	12/1200

MINES DE RECHANGE POUR PORTE-MINES Spare leads for mechanical pencils

Étui de 12 mines - Case of 12 spare leads

MODÈLE MODEL	REF.	CARACTÉRISTIQUES SPECIFICATIONS	CONDITIONNEMENT PACKING	UV/PCB
HB 0.5 mm	900081		Vrac / Bulk	12/2880
HB 0.7 mm	900082		Vrac / Bulk	12/2880
HB 0.9 mm	900080		Vrac / Bulk	12/1440





CRAYONS GRAPHITE BOUT GOMME

Graphite pencils with eraser end

Bois issus de forêts gérées durablement - Wood from sustainably managed forests

MODÈLE MODEL	REF.	CARACTÉRISTIQUES SPECIFICATIONS	CONDITIONNEMENT PACKING	LIV/PCB
HB x 12	FEC100842		LS / Pegboardable	24/144



CRAYONS GRAPHITE BOUT TREMPÉ

Graphite pencils with dipped end

Bois issus de forêts gérées durablement - Wood from sustainably managed forests

MODÈLE MODEL	REF.	CARACTÉRISTIQUES SPECIFICATIONS	CONDITIONNEMENT PACKING	LIV/PCB
HB x 12	FEC100742		LS / Pegboardable	24/144
HB x 4	FEC101242		LS / Pegboardable	12/144

N°4	N°3	N°2	N°1	N°0



CRAYONS GRAPHITE BOUT TRANCHÉ

Graphite pencils with cut end

Bois issus de forêts gérées durablement - Wood from sustainably managed forests

MODÈLE MODEL	REF.	CARACTÉRISTIQUES SPECIFICATIONS	CONDITIONNEMENT PACKING	LIV/PCB
2H x 12	FEC140042		LS / Pegboardable	24/144
H x 12	FEC130042		LS / Pegboardable	24/144
HB x 12	FEC100642		LS / Pegboardable	24/144
B x 12	FEC090042		LS / Pegboardable	24/144
2B x 12	FEC120342		LS / Pegboardable	24/144

AIDES À ÉCRIRE

Pencil grips

Forme ergonomique - Ergonomic shape

MODÈLE MODEL	REF.	CARACTÉRISTIQUES SPECIFICATIONS	CONDITIONNEMENT PACKING	LIV/PCB
10 pcs	FEC900161		Vrac / Bulk	1/160
50 pcs	FEC900263		LS / Pegboardable	1/12
100 pcs	FEC900361		Vrac / Bulk	1/18

TPE



AIDES À ÉCRIRE

Pencil grips

4,2 x 1,9 cm - 4,2 x 1,9 cm

Forme triangulaire - Triangular shape

MODÈLE MODEL	REF.	CARACTÉRISTIQUES SPECIFICATIONS	CONDITIONNEMENT PACKING	LIV/PCB
6 pcs	FEC900461		Vrac / Bulk	1/120

TPE

LOISIRS CRÉATIFS

Creative activities

Mines affûtées et palettes de couleurs détonantes, les artistes en herbe peuvent eux aussi œuvrer en toute liberté. Vous adorez créer et le DIY* n'a plus aucun secret pour vous ? Wonday propose une large gamme de produits pour vous exprimer ou tout simplement vous amuser.

À découvrir sans modération !

*DIY : Do It Yourself : Faites le vous-même !



COLORIAGE / COLOURING ACTIVITIES

CRAYONS DE COULEUR HAUTE QUALITÉ HIGH QUALITY PENCILS

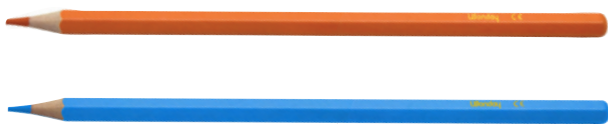

CRAYONS DE COULEUR HEXAGONAUX Hexagonal coloured pencils



Crayons de couleur 18 cm - 18 cm coloured pencils
Bout trempé - Dipped end
12 couleurs intenses - 12 deep colours
Forme hexagonale - Hexagonal shape
Mine résistante ø 3 mm - Resistant lead ø 3 mm
Crayons composés de bois certifié et contrôlé - Pencils made from certified and controlled wood



Facile à tailler
Easy to cut



Mine résistante
Resistant mine

ø 3 mm



Coloris intense
Deep colors



MODÈLE MODEL	REF.	CARACTÉRISTIQUES SPECIFICATIONS	CONDITIONNEMENT PACKING	LIV/PCB
x 12	FCG000502*	Noir Black	LS / Pegboardable	12/144
x 12	FCG000602*	Violet Purple	LS / Pegboardable	12/144
x 12	FCG000702*	Bleu clair Light blue	LS / Pegboardable	12/144
x 12	FCG000802*	Bleu foncé Dark blue	LS / Pegboardable	12/144
x 12	FCG000902*	Vert clair Light green	LS / Pegboardable	12/144
x 12	FCG001002*	Vert foncé Dark green	LS / Pegboardable	12/144
x 12	FCG001102*	Jaune Yellow	LS / Pegboardable	12/144
x 12	FCG001202*	Orange Orange	LS / Pegboardable	12/144
x 12	FCG001302*	Rose Pink	LS / Pegboardable	12/144
x 12	FCG001402*	Rouge Red	LS / Pegboardable	12/144
x 12	FCG001502*	Marron Brown	LS / Pegboardable	12/144
x 12	FCG001602*	Beige Beige	LS / Pegboardable	12/144

* Jusqu'à épuisement des stocks

MODÈLE MODEL	REF.	CARACTÉRISTIQUES SPECIFICATIONS	CONDITIONNEMENT PACKING	LIV/PCB
x 48	FCG001793*	12 couleurs 12 colours	Boîte / Box	4/32
x 12	FCG000492*	12 couleurs 12 colours	LS / Pegboardable	12/144

* Jusqu'à épuisement des stocks

COLORIER - PEINDRE

Colour - Paint



CRAYONS DE COULEUR COLOURED PENCILS



CRAYONS DE COULEUR TRIANGULAIRES Triangular coloured pencils



Crayons de couleur 18 cm - 18 cm coloured pencils
12 couleurs assorties - 12 assorted colours
Forme triangulaire - Triangular shape

MODÈLE MODEL	REF.	CARACTÉRISTIQUES SPECIFICATIONS	CONDITIONNEMENT PACKING	LIV/PCB
x 12	FCG010092		LS / Pegboardable	24/144

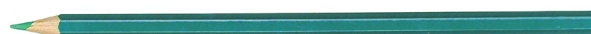

CRAYONS DE COULEUR HEXAGONAUX Hexagonal coloured pencils



Crayons de couleur 18 cm - 18 cm coloured pencils
Couleurs assorties - Assorted colours
Forme hexagonale - Hexagonal shape

MODÈLE MODEL	REF.	CARACTÉRISTIQUES SPECIFICATIONS	CONDITIONNEMENT PACKING	LIV/PCB
x 12	FCG000092		LS / Pegboardable	24/144
x 18	FCG000192		LS / Pegboardable	24/96



MODÈLE MODEL	REF.	CARACTÉRISTIQUES SPECIFICATIONS	CONDITIONNEMENT PACKING	LIV/PCB
x 144	FCG000393	12 couleurs 12 colours	Boîte / Box	1/10

MODÈLE MODEL	REF.	CARACTÉRISTIQUES SPECIFICATIONS	CONDITIONNEMENT PACKING	LIV/PCB
x 48	FCG000293*	12 couleurs 12 colours	Boîte / Box	1/36

* Jusqu'à épuisement des stocks

FEUTRES HAUTE QUALITÉ HIGH QUALITY FELT PENS



Lavable
Washable



Coloris intenses
Deep colors



Pointe bloquée
Blocked tip

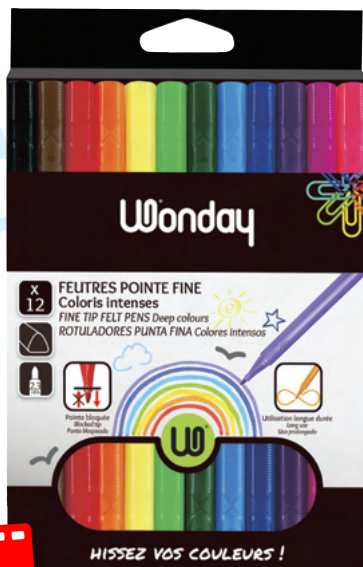

FEUTRES HAUTE QUALITÉ High quality felt pens

Encre à base d'eau - Water-based ink
Corps triangulaire pour une meilleure prise en main - Triangular body for a better grip
Capuchon ventilé - Ventilated cap
Lavable - Washable
Coloris intenses - Deep colours
Pointe bloquée - Blocked tip

MODÈLE MODEL	RÉF.	CARACTÉRISTIQUES SPECIFICATIONS	CONDITIONNEMENT PACKING	LIV/PCB
x 12 Pointe fine Fine tip	FCG110292*		LS / Pegboardable	12/96
x 12 Pointe moyenne Medium tip	FCG120192*		LS / Pegboardable	12/48

* Jusqu'à épuisement des stocks

BÂTONS DE GOUACHE GOUACHE STICKS



BÂTONS DE GOUACHE « MIN'O » « MIN'O » gouache sticks

A base d'eau - Water-based
S'utilise sans eau - No water needed
Couleurs brillantes - Bright colours
Grand pouvoir couvrant - High covering power
Séchage rapide - Quick-drying



MODÈLE MODEL	REF	CARACTÉRISTIQUES SPECIFICATIONS	CONDITIONNEMENT PACKING	LIV/PCB
x 12	FCG510092	12 couleurs 12 colours	LS / Pegboardable	12/48
x 96	FCG510193	12 couleurs 12 colours	Boîte / Box	1/4

COLORIER - PEINDRE

Colour - Paint

FEUTRES FELT PENS



FEUTRES « MIN'O » « Min'o » felt pens

Encre à base d'eau - Water-based ink
Corps rond - Round body
Capuchon ventilé - Ventilated cap
Lavable - Washable

MODÈLE MODEL	RÉF.	CARACTÉRISTIQUES SPECIFICATIONS	CONDITIONNEMENT PACKING	LIV/PCB
x 12 Pointe fine Fine tip	FCG110092		LS / Pegboardable	20/120
x 12 Pointe moyenne Medium tip	FCG120092		LS / Pegboardable	24/96
x 10 Pointe extra large Jumbo tip	FCG140092		LS / Pegboardable	12/72

pack scolaire - School pack

MODÈLE MODEL	RÉF.	CARACTÉRISTIQUES SPECIFICATIONS	CONDITIONNEMENT PACKING	LIV/PCB
x 144 Pointe fine Fine tip	FCG110193	12 couleurs 12 colours	Boîte / Box	1/8
x 144 Pointe moyenne Medium tip	FCG130093	12 couleurs 12 colours	Boîte / Box	1/8
x 80 Pointe extra large Jumbo tip	FCG140193	10 couleurs 10 colours	Boîte / Box	1/8



BLOUSES BLANCHES / WHITE COATS



BLOUSES BLANCHES 100 % COTON 100% cotton white coats

Modèle mixte - Mixed model

Manches longues, col tailleur - Long sleeves, open collar

3 poches : 2 poches basses et 1 poche poitrine - 3 pockets: 2 low pockets and 1 chest pocket

Tissu 100% coton 190 g/m² - 100% cotton fabric 190 g/m²

Fermeture par boutons en plastique - Closure by plastics buttons

MODÈLE MODEL	REF.	CARACTÉRISTIQUES SPECIFICATIONS	CONDITIONNEMENT PACKING	LIV/PCB
XS	SEP200021		Vrac / Bulk	10/20
S	SEP210021		Vrac / Bulk	10/20
M	SEP220021		Vrac / Bulk	10/20
L	SEP230021		Vrac / Bulk	10/20
XL	SEP240021		Vrac / Bulk	10/20

Fermeture par boutons pression - Closure by press studs

MODÈLE MODEL	REF.	CARACTÉRISTIQUES SPECIFICATIONS	CONDITIONNEMENT PACKING	LIV/PCB
XS	SEP300021		Vrac / Bulk	10/20
S	SEP310021		Vrac / Bulk	10/20
M	SEP320021		Vrac / Bulk	10/20
L	SEP330021		Vrac / Bulk	10/20
XL	SEP340021		Vrac / Bulk	10/20

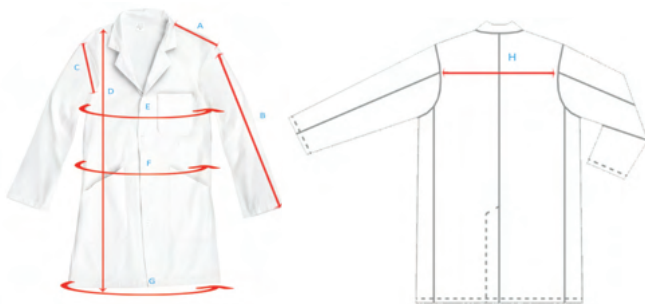

Taille XS Size XS

A: 11,5 cm
B: 52 cm
C: 22 cm
D: 88 cm
E: 97 cm
F: 91 cm
G: 97 cm
H: 35,5 cm

Taille S Size S

A: 12,5 cm
B: 60 cm
C: 25,5 cm
D: 95 cm
E: 98 cm
F: 92 cm
G: 98 cm
H: 37 cm

Taille M Size M

A: 13,5 cm
B: 62 cm
C: 27 cm
D: 95 cm
E: 107 cm
F: 101 cm
G: 107 cm
H: 39 cm

Taille L Size L

A: 16 cm
B: 62 cm
C: 27 cm
D: 97 cm
E: 120 cm
F: 114 cm
G: 124 cm
H: 43 cm

Taille XL Size XL

A: 17 cm
B: 63 cm
C: 29 cm
D: 100 cm
E: 128 cm
F: 122 cm
G: 134 cm
H: 46 cm

8 - 10 ans 8-10 years

A: 10 cm
B: 43 cm
C: 19 cm
D: 76 cm
E: 85 cm
F: 79 cm
G: 85 cm
H: 30 cm

10 - 12 ans 10-12 years

A: 10,5 cm
B: 47 cm
C: 20 cm
D: 79 cm
E: 88 cm
F: 82 cm
G: 88 cm
H: 32 cm

12 - 14 ans 12-14 years

A: 11,5 cm
B: 52 cm
C: 22 cm
D: 88 cm
E: 97 cm
F: 91 cm
G: 97 cm
H: 35,5 cm

14 - 16 ans 14-16 years

A: 12,5 cm
B: 60 cm
C: 25,5 cm
D: 95 cm
E: 98 cm
F: 92 cm
G: 98 cm
H: 37 cm

BLOUSES JUNIOR 100% COTON 100% junior size coats



Blouse blanche - White coat

Tissu 100% coton 165 g/m² - 100% cotton fabric 165 g/m²

Fermeture par boutons en plastique - Closure by plastic buttons

Manches longues, col tailleur et 3 poches - Long sleeves, open collar and 3 pockets

MODÈLE MODEL	REF.	CARACTÉRISTIQUES SPECIFICATIONS	CONDITIONNEMENT PACKING	LIV/PCB
8 - 10 ans 8 - 10 years	SEP000021		Vrac / Bulk	10/20
10 - 12 ans 10 - 12 years	SEP010021		Vrac / Bulk	10/20
12 - 14 ans 12 - 14 years	SEP020021		Vrac / Bulk	10/20
14 - 16 ans 14 - 16 years	SEP030021		Vrac / Bulk	10/20

COLORIER - PEINDRE

Colour - Paint

TABLIERS & MATÉRIEL DE PEINTURE / PAINTING APRONS & EQUIPMENT



TABLIERS DE PEINTURE AVEC POCHÉ Painting aprons with pocket

Manches longues avec poignets élastiques - Long sleeves with elastic cuffs
Fermeture dos scratch - Scratch closure in the back
Tissu déperlant - Water-repellent fabric
1 poche centrale - 1 front pocket

REF.	TAILLE SIZE	CARACTÉRISTIQUES SPECIFICATIONS	CONDITIONNEMENT PACKING	LIV/PCB
APN500722	2-3 ans years	Nylon	LS / Pegboardable	10/100
APN500221	3-5 ans years	Nylon	Vrac / Bulk	10/100
APN500322	3-5 ans years	Nylon	LS / Pegboardable	10/100
APN500421	4-7 ans years	Nylon	Vrac / Bulk	10/100
APN500521	6-8 ans years	Nylon	Vrac / Bulk	10/100
APN500622	6-8 ans years	Nylon	LS / Pegboardable	10/100

TABLIERS DE PEINTURE BI-MATIÈRE Bi-material painting aprons

Tablier en toile cirée avec longue protection nylon - Apron in wax cloth with long nylon protection
Manches longues avec poignets élastiques - Long sleeves with elastic cuffs
Fermeture dos scratch - Scratch closure in the back
Résistant à l'eau - Water resistant

REF.	TAILLE SIZE	CARACTÉRISTIQUES SPECIFICATIONS	CONDITIONNEMENT PACKING	LIV/PCB
APN500922	18-36 mois months	Nylon - Vinyle	LS / Pegboardable	10/100



**POUR PROTÉGER
LES ARTISTES EN HERBE**



TABLIERS DE PEINTURE SANS POCHÉ Painting aprons without pocket

Manches longues avec poignets élastiques - Long sleeves with elastic cuffs
Fermeture dos scratch - Scratch closure in the back
Tissu déperlant - Water-repellent fabric

REF.	TAILLE SIZE	CARACTÉRISTIQUES SPECIFICATIONS	CONDITIONNEMENT PACKING	LIV/PCB
APN500022	3-5 ans years	Nylon	LS / Pegboardable	1/100
APN500122	5-8 ans years	Nylon	LS / Pegboardable	1/100



TABLIERS CHASUBLES Chasuble painting aprons

Sans manches & poche centrale - Sleeveless chasuble & front pocket
Tissu déperlant - Water-repellent fabric

REF.	TAILLE SIZE	CARACTÉRISTIQUES SPECIFICATIONS	CONDITIONNEMENT PACKING	UV/PCB
APN550022	5-8 ans years	Vinyle	LS / Pegboardable	1/100

TABLIER RECYCLABLE Recyclable apron

Matière PEVA majoritairement recyclable - PEVA material mainly recyclable
Sans phtalate, sans PVC - Phthalate-free, PVC free
Manches longues avec poignets élastiques - Long sleeves with elastic cuffs
Fermeture dos scratch - Scratch closure in the back
Résistant à l'eau - Water resistant
3 poches - 3 pockets

REF.	TAILLE SIZE	CARACTÉRISTIQUES SPECIFICATIONS	CONDITIONNEMENT PACKING	UV/PCB
APN500862	3-5 ans years	PEVA	LS / Pegboardable	10/60



PALETTES DE MÉLANGE PEINTURE Paint mixing palettes

Plastique blanc opaque - Solid white plastic

REF.	DIM. (HxLxP CM)	CARACTÉRISTIQUES SPECIFICATIONS	CONDITIONNEMENT PACKING	UV/PCB
APN900461	53x21x3,4 Grand modèle Large model	R-PS	Vrac / Bulk	1/36
APN900262	22x16 Ovale Oval	PP	LS / Pegboardable	1/200
APN900361	23x13 Rectangulaire Rectangular	PP	Vrac / Bulk	10/100



Pour pinceaux larges & rouleaux mousses
For large brushes & foam rollers

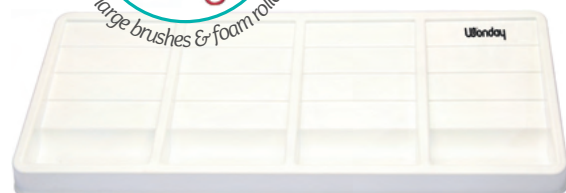

COLORIER - PEINDRE

Colour - Paint



DOUBLE POT DE NETTOYAGE
Double cleaning pot

Couvercles refermables - Resealable lids

REF.	DIM. (MM)	CARACTÉRISTIQUES SPECIFICATIONS	CONDITIONNEMENT PACKING	LIV/PCB
APN900561	114x90x80	PP 	Vrac / Bulk	12/48



CASIER PRÉSENTOIR PINCEAUX
Brushes stand display



Facilite le séchage des pinceaux - Brushes stand makes easier drying
Pinceaux non inclus - Brushes not included

REF.	DIM. (MM)	CARACTÉRISTIQUES SPECIFICATIONS	CONDITIONNEMENT PACKING	LIV/PCB
APN900661	145x145x90	PP 	Vrac / Bulk	1/60



ROULEAUX À PEINDRE MOUSSE
Foam paint rollers

Manche PP - PP handle
Rouleau mousse synthétique - Synthetic foam roller







REF.	DIM. (MM)	CARACTÉRISTIQUES SPECIFICATIONS	CONDITIONNEMENT PACKING	LIV/PCB
APN250061	Ø30xL45	PP-Mousse synthétique PP-Synthetic foam 	Vrac / Bulk	6/576
APN250161	Ø30xL60	PP-Mousse synthétique PP-Synthetic foam 	Vrac / Bulk	10/480



POTS ANTI-VERSE
Non spill water pots

Avec couvercle refermable et support pinceaux - With resealable lid and brushes holder

Composé de 3 parties pour faciliter le nettoyage - Made of 3 parts for an easy cleaning

REF.	DIM. (MM)	CARACTÉRISTIQUES SPECIFICATIONS	CONDITIONNEMENT PACKING	LIV/PCB
APN900091	Ø55/75 xh87	PP    	Vrac / Bulk	6/24
B 5909.01*	Ø80 xh105	PP  	LS / Pegboardable	12/48

* Jusqu'à épuisement des stocks



PINCEAUX MOUSSE
Foam brushes

Set de 6 pinceaux mousse avec manche plastique PP - Set of 6 foam brushes with PP plastic handle

Différentes formes : pinceaux, rouleaux, brosses - Assorted models : circle and square paint brushes, rollers

REF.	DIM. (MM)	CARACTÉRISTIQUES SPECIFICATIONS	CONDITIONNEMENT PACKING	LIV/PCB
B 5905.06*	-	PP-Mousse synthétique PP-Synthetic foam 	LS / Pegboardable	10/60

* Jusqu'à épuisement des stocks



Le bois de nos pinceaux est issu de forêts bien gérées certifiées
The wood used in our brushes comes from certified well-managed forests



**POUR GOUACHE
ET ACRYLIQUE.
POUR LES FONDS,
LES APLATS
LES TRAIT ÉPAIS...**

For gouache and acrylic paint.
For backgrounds,
solid colours, thick lines,...

PINCEAUX BROSSES Flat brushes

Ferrule aluminium - Aluminium ferrule
Fibres synthétiques ocre jaune (PBT) - Synthetic yellow hair (PBT)
Manche court en bois de bouleau rouge métallisé - Short handle in metallic red birch wood



**POUR GOUACHE
ET ACRYLIQUE
POUR LES DÉTAILS,
LES FINITIONS,
LES LIGNES...**

For gouache and acrylic paint.
For details, finishes, lines...

PINCEAUX RONDS Round brushes

Ferrule aluminium - Aluminium ferrule
Fibres synthétiques ocre jaune (PBT) - Synthetic yellow hair (PBT)
Manche court en bois de bouleau bleu métallisé - Short handle in metallic blue birch wood

REF.	MODÈLE MODEL	CARACTÉRISTIQUES SPECIFICATIONS	CONDITIONNEMENT PACKING	LIV/PCB
APN100842	n°6, 10 & 14	PBT Bois-Wood	LS Pegboardable	12/240
APN100041	n°4	PBT Bois-Wood	Vrac Bulk	10/60
APN100141	n°6	PBT Bois-Wood	Vrac Bulk	10/60
APN100241	n°8	PBT Bois-Wood	Vrac Bulk	10/60
APN100341	n°10	PBT Bois-Wood	Vrac Bulk	10/60
APN100441	n°12	PBT Bois-Wood	Vrac Bulk	10/60
APN100541	n°14	PBT Bois-Wood	Vrac Bulk	10/60
APN100641	n°16	PBT Bois-Wood	Vrac Bulk	10/60
APN100741	n°18	PBT Bois-Wood	Vrac Bulk	10/60

LOT DE 10 PINCEAUX ASSORTIS Set of 10 assorted brushes

Tailles et formes assorties : 4 pinceaux ronds N° 0, 4, 6 et 8 - 4 pinceaux
brosses N° 2, 4, 6 et 8 - 2 pinceaux arrondis N° 4 et 8
Assorted sizes and models : 4 round brushes N° 0, 4, 6 et 8 - 4 flat brushes N° 2, 4,
6 et 8 - 2 filbert brushes N° 4 et 8
Ferrule aluminium - Aluminium ferrule
Fibres synthétiques marrons (PBT) - Brown synthetic hair (PBT)
Manche long en bois marron - Long brown wooden handle
Livré dans son étui de rangement 100% coton - Comes in 100% cotton holder

REF.	MODÈLE MODEL	CARACTÉRISTIQUES SPECIFICATIONS	CONDITIONNEMENT PACKING	LIV/PCB
APN300041*	-	PBT Bois-Wood	Vrac Bulk	1/72

* Jusqu'à épuisement des stocks

REF.	MODÈLE MODEL	CARACTÉRISTIQUES SPECIFICATIONS	CONDITIONNEMENT PACKING	LIV/PCB
APN200042	n°4, 8 & 12	PBT Bois-Wood	LS Pegboardable	12/240
APN200141	n°2	PBT Bois-Wood	Vrac Bulk	10/60
APN200241	n°4	PBT Bois-Wood	Vrac Bulk	10/60
APN200341	n°6	PBT Bois-Wood	Vrac Bulk	10/60
APN200441	n°8	PBT Bois-Wood	Vrac Bulk	10/60
APN200541	n°10	PBT Bois-Wood	Vrac Bulk	10/60
APN200641	n°12	PBT Bois-Wood	Vrac Bulk	10/60
APN200741	n°14	PBT Bois-Wood	Vrac Bulk	10/60
APN200841	n°16	PBT Bois-Wood	Vrac Bulk	10/60
APN200941	n°18	PBT Bois-Wood	Vrac Bulk	10/60
APN201041	n°20	PBT Bois-Wood	Vrac Bulk	10/60



COLORIER - PEINDRE

Colour - Paint

PEINTURE / PAINTING



PASTILLES DE GOUACHE Box of watercolour cakes

12 pastilles de gouache assorties + 1 pinceau - Box of 12 assorted watercolour cakes + 1 brush included

APN450092 : avec couvercle de protection - With protection cover
APN450191 : avec alvéoles de mélange - With mixing compartments

REF.	DIM. (MM)	CARACTÉRISTIQUES SPECIFICATIONS	CONDITIONNEMENT PACKING	LIV/PCB
APN450092	Rectangulaire Rectangular		LS / Pegboardable	12/72
APN450191	Ovale Oval		Vrac / Bulk	12/72



GOUACHES EN TUBE Gouache paints' tubes

Gouaches épaisses, couleurs denses, haut pouvoir couvrant - Thick gouache for deep coloured smooth and complete coverage
Coloris assortis - Assorted colours

REF.	QTÉ	CARACTÉRISTIQUES SPECIFICATIONS	CONDITIONNEMENT PACKING	LIV/PCB
APN400092	12 ml		LS / Pegboardable	12/120
APN400192	12 ml		LS / Pegboardable	12/60





BOÎTES DE TAMPONS GÉANTS

Boxes of giant stamps

Poignée ergonomique antitache - No smear ergonomic handle

Tampon mousse EVA compacte - EVA compact foam stamp

Disque ø 75 mm - ø 75 mm disc

Repère indiquant le sens du motif - Up arrow showing the pattern direction

S'utilisent avec la gouache, l'encre gel, l'encre à dessiner et les tampons encreurs - Can be used with gouache paint, glue ink, drawing ink and ink pads

REF.	TAILLE (MM) SIZE	CARACTÉRISTIQUES SPECIFICATIONS	CONDITIONNEMENT PACKING	UV/PCB
ATP100083*	Ø75	Ferme Farm	x10	Boîte / Box 1/10
ATP150083*	Ø75	Figuratifs Figurative	x10	Boîte / Box 1/10
ATP200083*	Ø75	Animaux sauvages Wild animals	x10	Boîte / Box 1/10
ATP250083*	Ø75	Noël Christmas	x10	Boîte / Box 1/10
ATP300083	Ø75	Chiffres Figures	x10	Boîte / Box 1/10
ATP350083*	Ø75	Géométriques Geometric	x10	Boîte / Box 1/10
ATP400083	Ø75	Alphabet Alphabet	x26	Boîte / Box 1/5

* Jusqu'à épuisement des stocks



Ferme
Farm
ATP100083

Figuratifs
Figurative
ATP150083

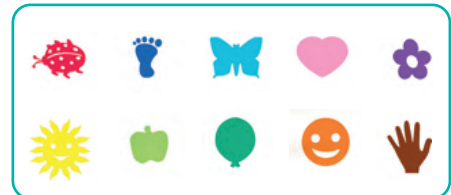

Animaux
sauvages
Wild animals
ATP200083

Noël
Christmas
ATP250083

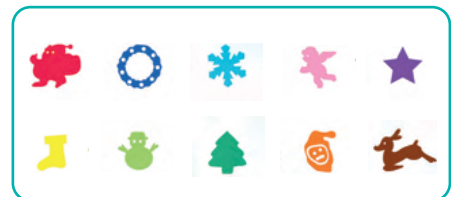

Chiffres
Figures
ATP300083

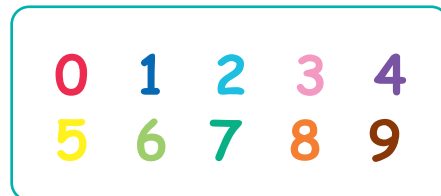

Géométriques
Geometric
ATP350083

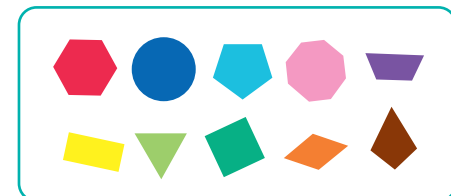

TAMPONS ENCREURS COULEUR

Coloured ink pads



Rechargeable avec de l'encre liquide - Refillable with liquid ink

Couleurs assorties - Assorted colours

Pour Tampons Géants - For Giant Stamps

REF.	DIM. (MM)	CARACTÉRISTIQUES SPECIFICATIONS	CONDITIONNEMENT PACKING	UV/PCB
ATP800083	Ø90	x12	Boîte / Box	1/6



Alphabet
Alphabet
ATP400083

ACTIVITÉS MANUELLES ET CRÉATIVES



Manual and crafting activities

ACCESSOIRES DIVERS / VARIOUS ACCESSORIES



GELS PAILLETÉS Glitter glues

Forte concentration en paillettes - Strongly concentrated in glitter
Embout doseur - Measuring nozzle tube

REF.	QTÉ	CARACTÉRISTIQUES SPECIFICATIONS	CONDITIONNEMENT PACKING	LIV/PCB
ACL150292*	10 ml	Lumineux Sharp coloured  x6	LS / Pegboardable	1/96
ACL150091*	10 ml	Assortis Assorted  x50	Boîte / Box	1/12

* Jusqu'à épuisement des stocks



TUBE À DESSIN TÉLESCOPIQUE Telescopic rigid tube

Pour le classement et le transport - For classification and transport
Plus résistant que les tubes carton - Higher hardwearing capacity than cardboard tubes

Ø 80 mm télescopique de 74 à 128,5 cm avec bandoulière - Ø 80 mm expanding telescopic 74 to 128,5 cm with shoulder belt

REF.	TAILLE SIZE	CARACTÉRISTIQUES SPECIFICATIONS	CONDITIONNEMENT PACKING	LIV/PCB
APN900761	Ø80mm x174/128,5 cm	PE 	Vrac / Bulk	1/12



MARQUEUR TEXTILE Fabric marker

Encre noire indélébile - Permanent black ink
Résiste à l'eau - Water-resistant
Pour étiquettes, vêtements, blouses, etc - For labels, clothes, work coats, etc.
Pointe fine - Fine tip



RÈF.	CARACTÉRISTIQUES SPECIFICATIONS	CONDITIONNEMENT PACKING	LIV/PCB
FEC520032*		LS / Pegboardable	12/144

* Jusqu'à épuisement des stocks



IDÉAL POUR LE DESSIN D'OBSERVATION.
LE FIL À PLOMB PERMET DE DÉTERMINER L'INCLINAISON DES OBJETS PAR RAPPORT À LA VERTICALE DU FIL.

Ideal for observation drawing.
The plumb line is used to determine the inclination of objects in relation to the vertical of the wire.



EMBOUIT DE FIL À PLOMB Plumb bob

Vendu sans le fil - Thread not included
Poids 16 g - Weight 16 g













REF.	TAILLE SIZE	CARACTÉRISTIQUES SPECIFICATIONS	CONDITIONNEMENT PACKING	LIV/PCB
AOM200071*	Ø11 x 132 mm	Laiton Brass 	Vrac / Bulk	12/720

* Jusqu'à épuisement des stocks

ACTIVITÉS MANUELLES ET CRÉATIVES

Manual and crafting activities



CRAIES DE TROTTOIR Sidewalk chalk

REF.	TAILLE (MM) SIZE	CARACTÉRISTIQUES SPECIFICATIONS	CONDITIONNEMENT PACKING	UV/PCB
FEC700092	Ø 25 x 105	  x6	LS / Pegboardable	1/60
FEC700293	Ø 25 x 105	  x20	Boite / Box	1/12
FEC700493	Ø 25 x 105	  x50	Boite / Box	1/6
FEC700192	Ø 25 x 105	  x8	LS / Pegboardable	1/60
FEC700393	Ø 25 x 105	  x25	Boite / Box	1/12
FEC700593	Ø45 x 195 Géante Giant	  x7	Boite / Box	1/10



GOMMETTES AUTOCOLLANTES Stickers



REF.	TAILLE SIZE	MODÈLE MODEL	CARACTÉRISTIQUES SPECIFICATIONS	CONDITIONNEMENT PACKING	UV/PCB	
APP200012	A5		Triangle Triangle	 x8 	LS / Pegboardable	10/50
APP200112*	A5		Déco fête métallisée Metallic party decoration	 x8 	LS / Pegboardable	10/50
APP200212*	A5		Fantaisie métallisée Metallic fantasy	 x8 	LS / Pegboardable	10/50
APP200412	A5		Rond Dot	 x8 	LS / Pegboardable	10/50
APP200512	A5		Carré Square	 x8 	LS / Pegboardable	10/50
APP200612	A5		Rectangle Rectangle	 x8 	LS / Pegboardable	10/50
APP200712*	A5		Étoile Star	 x8 	LS / Pegboardable	10/50
APP200912	A5		Géométrique métallisée Metallic geometric	 x8 	LS / Pegboardable	10/50
APP201012	A5		Étoile métallisée Metallic star	 x8 	LS / Pegboardable	10/50
APP200392	A5		Assortis Assorted	 x10 	LS / Pegboardable	10/50

* Jusqu'à épuisement des stocks

ACTIVITÉS MANUELLES ET CRÉATIVES

Manual and crafting activities

PAPIERS CRÉATIFS / CREATIVE PAPERS



PAPIER CARBONE Carbon paper

Réf. APP000002 : pour écriture manuscrite - For handwriting
Réf. APP000102 : pour machine à écrire - For typewriter

REF.	DIM. (HXL MM)	CARACTÉRISTIQUES SPECIFICATIONS	CONDITIONNEMENT PACKING	LV/PCB
APP000002	A4	Manuscrite Handwriting	LS / Pegboardable	12/144
APP000102	A4	Machine à écrire Typewriter	LS / Pegboardable	12/144

RÉALISE TES MAGNETS !

FEUILLES AIMANTÉES ADHÉSIVES Magnetic adhesive sheets

REF.	DIM. (HXL CM)	CARACTÉRISTIQUES SPECIFICATIONS	CONDITIONNEMENT PACKING	LV/PCB
FAI701512	A4	-	LS / Pegboardable	10/20

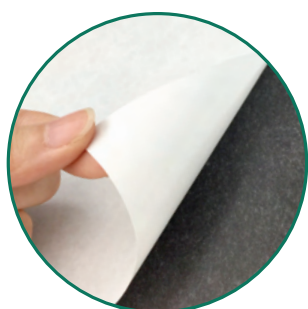

Dessiner ou imprimer sur le papier de votre choix
Draw or print on paper of your choice
Retirer le film blanc - Remove white film



Contrecoller votre illustration sur la feuille aimantée
Mount your illustration on the magnetic sheet







Découper les formes souhaitées
Cut out the desired shapes



PLASTIQUE FOU Shrink-film sheets

Matière rétractable - Shrinkable material

S'utilise pour créer des broches, des porte-clefs... - To be used to create brooches, key rings...

REF.	DIM. (HXL CM)	CARACTÉRISTIQUES SPECIFICATIONS	CONDITIONNEMENT PACKING	UV/PCB
ADY300062	20x30	30 microns 	LS / Pegboardable	10/50
ADY300162	20x30	30 microns 	LS / Pegboardable	1/50
ADY300361	20x30	30 microns 	Vrac / Bulk	1/25
ADY300262*	20x30	30 microns 	LS / Pegboardable	10/50

* Jusqu'à épuisement des stocks



Dessiner et colorier sur la face polie du plastique fou - Draw and color on the polished face of shrink-film sheet
Découper les dessins avec une marge de 3 mm - Cut out the drawings with a margin of 3 mm



Préchauffer le four - Preheat the oven.
Placer les dessins sur du papier sulfurisé - Place the designs on parchment paper
Mettre les dessins au four. Le plastique se rétracte rapidement - Put the drawings in the oven. The plastic shrinks quickly



Attendre que le plastique reprenne sa forme et sortir du four. Laisser refroidir - Wait for the plastic to return to its shape and remove from the oven. Leave to cool
C'est prêt ! - It's ready!



ACTIVITÉS MANUELLES ET CRÉATIVES

Manual and crafting activities



CARTES À GRATTER «ARC-EN-CIEL» «Rainbow» scratch sheets



+ 1 stylet en bambou - + 1 bamboo scratch tool
+ 2 pochoirs en carton - + 2 cardboard stencils

REF.	DIM. (HXL MM)	CARACTÉRISTIQUES SPECIFICATIONS	CONDITIONNEMENT PACKING	LIV/PCB
APPO50702*	114x153	 x10	LS / Pegboardable	12/144

* Jusqu'à épuisement des stocks

CARTES À GRATTER MINI Mini scratch sheets

+ 2 stylets bambou - + 2 bamboo scratch tools

REF.	DIM. (HXL MM)	CARACTÉRISTIQUES SPECIFICATIONS	CONDITIONNEMENT PACKING	LIV/PCB
APPO50102*	89x89	Arc-en-ciel Rainbow  x50	Vrac / Bulk	1/108
APPO50202*	89x89	Holographique Holographic  x50	Vrac / Bulk	1/108

* Jusqu'à épuisement des stocks



Arc-en-ciel / Rainbow



Blanc / White









Or / Gold



Argenté / Silver

CARTES À GRATTER A4 A4 scratch sheets

+ 1 stylet bambou à 2 embouts - + 1 bamboo scratch tool "fine and large tips"

REF.	DIM.	CARACTÉRISTIQUES SPECIFICATIONS	CONDITIONNEMENT PACKING	LIV/PCB
APPO50302*	A4	Arc-en-ciel Rainbow  x5	LS / Pegboardable	6/72
APPO50402*	A4	Or Gold  x5	LS / Pegboardable	6/72
664435*	A4	Blanc White  x5	LS / Pegboardable	6/72
APPO50502*	A4	Argent Silver  x5	LS / Pegboardable	6/72
APPO50692*	A4	Fluo Neon  x4	LS / Pegboardable	6/72
APPO50092*	A4	Holographique Holographic  x4	LS / Pegboardable	6/72

* Jusqu'à épuisement des stocks



10 STYLETS BAMBOU 10 bamboo scratch tool

REF.	DIM. (HXL MM)	CARACTÉRISTIQUES SPECIFICATIONS	CONDITIONNEMENT PACKING	LIV/PCB
APP900042*	Ø6 x 143	Bambou Bamboo  x10	Vrac / Bulk	1/10

* Jusqu'à épuisement des stocks

OUTILS DE DÉCOUPE ET COLLAGE / CUTTING AND GLUING TOOLS

CUTTERS ROTATIFS

Rotary cutters





Cutter rotatif bi-matière ABS/TPR - Bi-material ABS/TPR rotary cutter

Prise en main ergonomique - Ergonomic grip handle

Système de protection sur la lame - Blade protection system



REF.	TAILLE (MM) SIZE (MM)	CARACTÉRISTIQUES SPECIFICATIONS	CONDITIONNEMENT PACKING	LIV/PCB
BCU401082*	150 - Ø28	ABS/TPR 	LS / Pegboardable	12/144
B 4198.16*	160 - Ø45	ABS/TPR 	LS / Pegboardable	10/100

* Jusqu'à épuisement des stocks

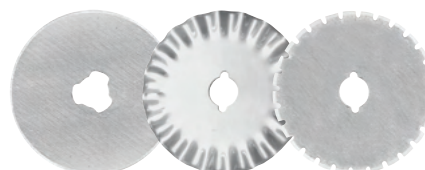
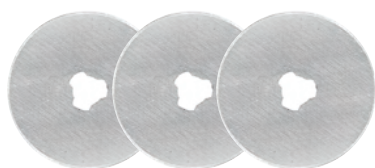

LAMES DISQUE

Circular blades

Lot 3 lames disques - Set of 3 circular blades

Découpe standard - Standard cutting

REF.	TAILLE (MM) SIZE (MM)	CARACTÉRISTIQUES SPECIFICATIONS	CONDITIONNEMENT PACKING	LIV/PCB
BLC400372*	Ø28	Acier inox SK5 Stainless steel SK5	3 lames 3 blades	LS / Pegboardable 10/600

* Jusqu'à épuisement des stocks

LAMES DISQUE FANTAISIE

Fancy circular blades

Lot 3 lames disques - Set of 3 circular blades

Découpe standard, dentelée, pointillée - Fancy cuttings 3 shapes

REF.	TAILLE (MM) SIZE (MM)	CARACTÉRISTIQUES SPECIFICATIONS	CONDITIONNEMENT PACKING	LIV/PCB
BLC400472*	Ø28	Acier inox SK5 Stainless steel SK5	3 lames 3 blades	LS / Pegboardable 24/480
BLC400572*	Ø45	Acier inox SK5 Stainless steel SK5	3 lames 3 blades	LS / Pegboardable 24/480

* Jusqu'à épuisement des stocks

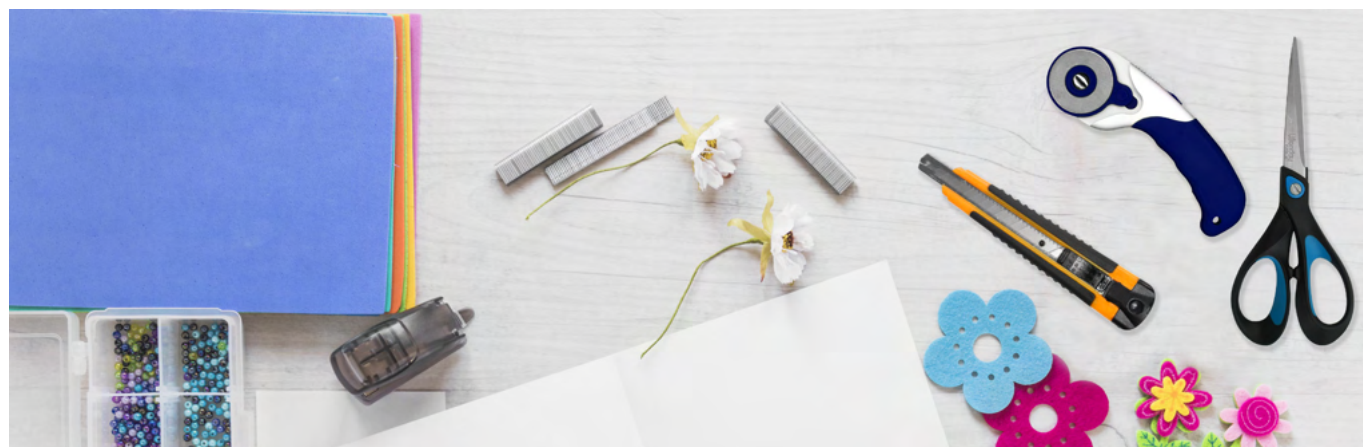

ACTIVITÉS MANUELLES ET CRÉATIVES

Manual and crafting activities



PRÉCICUT BI-MATIÈRE Bi-material precision craft knife

Cutter de précision - Precision craft knife
 Stylet corps alliage aluminium/TPR antiglisse - Aluminum alloy/non-slip TPR body
 Revêtement - Non-slip TPR coating
 Lame interchangeable - Interchangeable blade
 Capuchon de protection - Protective cap

REF.	TAILLE (MM) SIZE (MM)	CARACTÉRISTIQUES SPECIFICATIONS	CONDITIONNEMENT PACKING	UV/PCB
BCU400782	Ø12 x140 n°2	TPR-Aluminium TPR-Aluminium	LS Pegboardable	12/240



COFFRET CUTTER DE PRÉCISION Craft knife kit

Bi-matière TPR/Alliage aluminium - Bi-material TPR/aluminum alloy
 Pour arts graphiques, modélisme... - For graphic arts, model-making...
 Contient : 1 cutter et 6 lames assorties - Contains : 1 cutter and 6 assorted blades
 Embout aimanté - Magnetised tip

REF.	TAILLE (MM) SIZE (MM)	CARACTÉRISTIQUES SPECIFICATIONS	CONDITIONNEMENT PACKING	UV/PCB
BCU400372	140	TPR-Aluminium TPR-Aluminium	LS Pegboardable	1/120

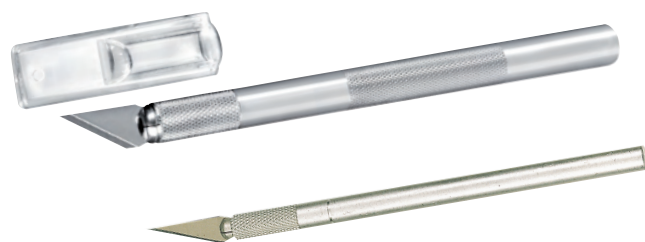

PRÉCICUTS Craft knives

Cutter de précision - Precision craft knife
 BCU400172 : n°2 - BCU400072 & BCU400272 : n°1
 Stylet corps aluminium - Aluminium body
 Lame interchangeable - Interchangeable blade
 Capuchon de protection - Protective cap
 + étui 2 lames n°11 pour le BCU400272 - + case of 2 spare blades n°11 for BCU400272

REF.	TAILLE (MM) SIZE (MM)	CARACTÉRISTIQUES SPECIFICATIONS	CONDITIONNEMENT PACKING	UV/PCB
BCU400172	Ø12 x 140 n°2	Aluminium Aluminum	LS Pegboardable	12/120
BCU400072	Ø9x 140 n°1	Aluminium Aluminum	LS Pegboardable	12/120
BCU400272	Ø9x 140 n°1	Aluminium Aluminum	LS Pegboardable	12/120



PRÉCICUT INDEX Finger tip precision knife

Cutter index de précision - Finger tip craft knife
 Corps ABS/Alliage aluminium - ABS/aluminum alloy body
 Lame interchangeable - Interchangeable blade
 Capuchon de protection - Protective cap
 Ergonomique - Ergonomic
 Lames compatibles n°11 - Compatible blades n°11

REF.	TAILLE (MM) SIZE (MM)	CARACTÉRISTIQUES SPECIFICATIONS	CONDITIONNEMENT PACKING	UV/PCB
B 4196.03*	-	ABS-Aluminium ABS-Aluminium	LS Pegboardable	12/144

* Jusqu'à épuisement des stocks

MODÈLE MODEL	REF.	TAILLE (MM) SIZE (MM)	CARACTÉRISTIQUES SPECIFICATIONS	CONDITIONNEMENT PACKING	UV/PCB
LAMES / BLADES pour précicut n°1	BLC400771	x 5 pcs	Acier inox SK5 Stainless steel SK5	Vrac / Bulk	12/120
LAMES / BLADES pour précicut n°2	BLC400172	x 5 pcs	Acier inox SK5 Stainless steel SK5	LS Pegboardable	12/360

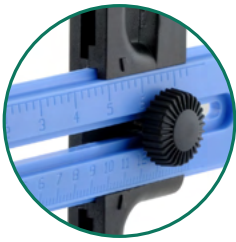

CUTTER COMPAS Compass cutter

Ajustable de Ø 10 à 150 mm - Adjustable from Ø 10 to 150 mm circular cuts
2 lames de rechanges dans la poignée - 2 pieces spare blades in handle
Capuchon de protection - Protective cap

REF.	TAILLE (MM) SIZE (MM)	CARACTÉRISTIQUES SPECIFICATIONS	CONDITIONNEMENT PACKING	LV/PCB	
BCU400462	112 x 98.5	ABS	LS / Pegboardable	1/288	
BLC400272	-	Acier inox SK5 Stainless steel SK5	12 lames 12 blades	LS / Pegboardable	1/360



RÈGLES DE COUPE Cutting rulers



Pour traçage et coupe - Drawing and cutting functions
Aluminium anodisé - Anodised aluminium

Bande de caoutchouc antidérapante, bord de coupe en acier inoxydable
Anti-slip rubber surface, stainless steel cutting edge

REF.	TAILLE (MM) SIZE (MM)	CARACTÉRISTIQUES SPECIFICATIONS	CONDITIONNEMENT PACKING	LV/PCB
FTT300271	30 cm	Aluminium anodisé Anodised Aluminium	Étui / Pouch	1/10
FTT400271	40 cm	Aluminium anodisé Anodised Aluminium	Étui / Pouch	1/10
FTT500271	50 cm	Aluminium anodisé Anodised Aluminium	Étui / Pouch	1/10
FTT600271	60 cm	Aluminium anodisé Anodised Aluminium	Étui / Pouch	1/10
FTT800271	80 cm	Aluminium anodisé Anodised Aluminium	Étui / Pouch	1/10
FTT000271	100 cm	Aluminium anodisé Anodised Aluminium	Étui / Pouch	1/10



80W

Ø 11 mm



Ø 11 mm

200 mm



PISTOLET À COLLE HAUTE TEMPÉRATURE High temperature glue gun

Buse protégée - Protected nozzle
Support métallique - Wire stand
Témoin de chauffe - Heating indicator
Recharge de 2 bâtons de colle incluse - 2 glue sticks refill included

BOÎTE DE 10 BÂTONS DE COLLE 10 glue sticks box

À base d'EVA - 95% transparent - EVA based - 95% transparent

REF.	TAILLE (MM) SIZE	CARACTÉRISTIQUES SPECIFICATIONS	CONDITIONNEMENT PACKING	LV/PCB
BCL900112	Ø 11	-	LS / Pegboardable	6/36
BCL110112	20 x 11	Boîte / Box x 10 pcs	LS / Pegboardable	6/48

ACTIVITÉS MANUELLES ET CRÉATIVES

Manual and crafting activities

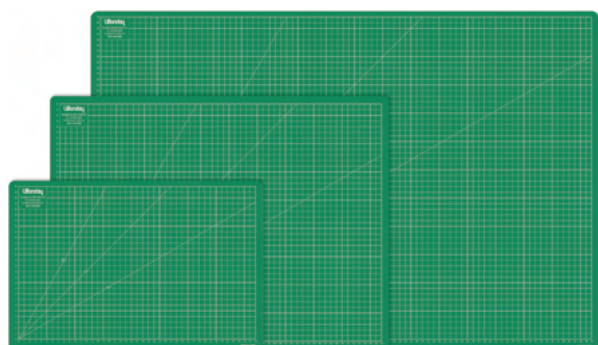

PLAQUES DE COUPE STANDARD

Standard cutting mats

Épaisseur 3 mm monocouche - 3 mm thickness single layer

Résistance à la coupe - Cut-resistant

Auto-cicatrisante grade B - Self-healing grade B

Surface quadrillée - Cross-ruled surface

Lignes d'angles 30°, 45° et 60° - Lines with 30°, 45° and 60° angles

Matière PVC recyclé - PVC recycled material

REF.	TAILLE (MM) SIZE (MM)	CARACTÉRISTIQUES SPECIFICATIONS	CONDITIONNEMENT PACKING	LIV/PCB
APQ030061	A3 450 x 300	PVC recyclé Recycled PVC	Vrac / Bulk	1/10
APQ020061	A2 600 x 450	PVC recyclé Recycled PVC	Vrac / Bulk	1/10
APQ010061	A1 900 x 600	PVC recyclé Recycled PVC	Vrac / Bulk	1/10

PLAQUES DE COUPE QUALITÉ SUPÉRIEURE

High quality cutting mats

Épaisseur 3 mm - 3 mm thickness

Résistance à la coupe - Cut-resistant

Surface quadrillée - Cross-ruled surface

Triple épaisseur - 3 layers

Auto-cicatrisante - Self-healing

Impression recto-verso - Printed on both sides

Lignes d'angles 30°, 45° et 60° - Lines with 30°, 45° and 60° angles

Matière PVC recyclé - PVC recycled material

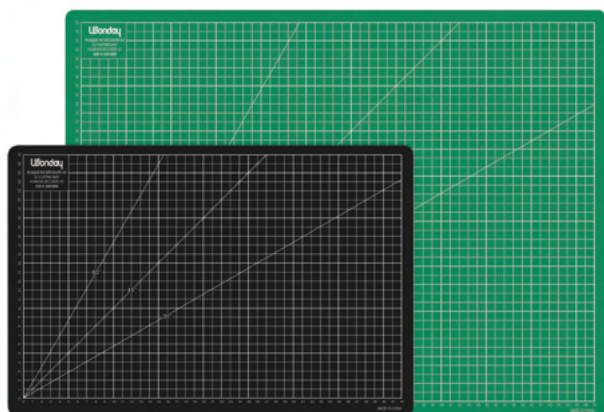

REF.	TAILLE (MM) SIZE (MM)	CARACTÉRISTIQUES SPECIFICATIONS	CONDITIONNEMENT PACKING	LIV/PCB
APQ400061	A4 300 x 220	PVC	Vrac / Bulk	1/60
APQ300061	A3 450 x 300	PVC	Vrac / Bulk	1/10
APQ200061	A2 600 x 450	PVC	Vrac / Bulk	1/10
APQ100061	A1 900 x 600	PVC	Vrac / Bulk	1/10





CISEAUX À CRANTER

Lame crantée (14 dents) en acier inox trempé - Stainless steel serrated upper blade (14 teeth)

Anneaux asymétriques bi-matière (PP-TPR) - Asymmetrical soft grip handles (PP-TPR)
Pour travaux manuels - Pinking shears for handcraft use

Coupent le tissu - Cut fabric

Avec bille de rattrapage - With correction ball



REF.	TAILLE/ SIZE	CARACTÉRISTIQUES SPECIFICATIONS	CONDITIONNEMENT PACKING	LIV/PCB
FCI230082	23 cm	PP - TPR  	LS / Pegboardable	12/72



CISEAUX CRANTEURS 16 CM

Kid Craft scissors 16 cm

Lames inox protégées - Stainless steel protected blades

REF.	CARACTÉRISTIQUES SPECIFICATIONS	CONDITIONNEMENT PACKING	LIV/PCB
ADE020063	- -  x6	Vrac / Bulk	1/36
ADE030063	- -  x12	Vrac / Bulk	1/24
ADE040063	- -  x3	Vrac / Bulk	1/72



CISEAUX CRANTEURS 13 CM

Kid Craft scissors 13 cm

Lames inox protégées - Stainless steel protected blades

REF.	DIM. (CM)	CARACTÉRISTIQUES SPECIFICATIONS	CONDITIONNEMENT PACKING	LIV/PCB
ADE010063	13	ABS/Inox ABS/Stainless steel  x6	Vrac / Bulk	1/36

ACTIVITÉS MANUELLES ET CRÉATIVES

Manual and crafting activities

MAQUETTE / MODEL

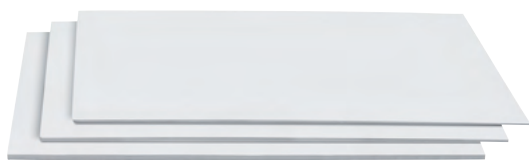

CARTONS MOUSSE BLANCS White foam boards



Carton mousse avec une base de polystyrène recouvert sur les deux côtés avec du papier couché de 150g/m² - Foam board based on polystyrene covered on both sides with white coated paper 150g/m²

REF.	DIM. (HXL CM)	CARACTÉRISTIQUES SPECIFICATIONS	CONDITIONNEMENT PACKING	LIV/PCB
APP100061	21x29,7	Epaisseur 3 mm 3 mm thickness	Vrac / Bulk	80/80
APP100161	29,7x42	Epaisseur 3 mm 3 mm thickness	Vrac / Bulk	40/40
APP100261	50x65	Epaisseur 3 mm 3 mm thickness	Vrac / Bulk	40/40
APP100361	21x29,7	Epaisseur 5 mm 5 mm thickness	Vrac / Bulk	50/50
APP100461	29,7x42	Epaisseur 5 mm 5 mm thickness	Vrac / Bulk	25/25
APP100561	50x65	Epaisseur 5 mm 5 mm thickness	Vrac / Bulk	25/25
APP100661	21x29,7	Epaisseur 10 mm 10 mm thickness	Vrac / Bulk	30/30
APP100761	29,7x42	Epaisseur 10 mm 10 mm thickness	Vrac / Bulk	15/15
APP100861	50x65	Epaisseur 10 mm 10 mm thickness	Vrac / Bulk	15/15
APP100961	70x100	Epaisseur 10 mm 10 mm thickness	Vrac / Bulk	15/15

CARTONS MOUSSE NOIRS Black foam boards



Carton mousse avec une base de polystyrène noir et recouvert sur les deux côtés de papier noir mat - Foam board based on black polystyrene covered both sides with black mat paper

REF.	DIM. (HXL CM)	CARACTÉRISTIQUES SPECIFICATIONS	CONDITIONNEMENT PACKING	LIV/PCB
APP150061	21x29,7	Epaisseur 5 mm 5 mm thickness	Vrac / Bulk	50/50
APP150161	29,7x42	Epaisseur 5 mm 5 mm thickness	Vrac / Bulk	25/25
APP150261	50x65	Epaisseur 5 mm 5 mm thickness	Vrac / Bulk	25/25
APP150361*	70x100	Epaisseur 5 mm 5 mm thickness	Vrac / Bulk	25/25
APP150461*	21x29,7	Epaisseur 10 mm 10 mm thickness	Vrac / Bulk	30/30
APP150561*	29,7x42	Epaisseur 10 mm 10 mm thickness	Vrac / Bulk	15/15
APP150661*	50x65	Epaisseur 10 mm 10 mm thickness	Vrac / Bulk	15/15

* Jusqu'à épuisement des stocks



PINCES POUR TRAVAUX MANUELS Pliers for craft hobbies

REF.	DIM. (H MM)	CARACTÉRISTIQUES SPECIFICATIONS	CONDITIONNEMENT PACKING	LIV/PCB
AOM100082	110	Pince coupante Cutting pliers	LS / Pegboardable	6/120
AOM100382	125	Pince bec droit Straight-nose pliers	LS / Pegboardable	6/120
AOM100582	125	Pince bec rond Round-nose pliers	LS / Pegboardable	6/120



PERFORATEURS DÉCO / PUNCHERS

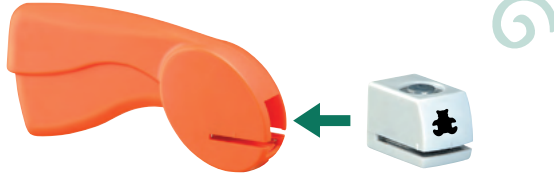

PINCES «CROQ' PERFO» «Croq' perfo» craft handles

Découpe facile même pour les plus petits ! - Easy cutting even for the youngest children !

Grammage maximum 100g - Grammage up to 100g

984900 et 984904 : vendus sans motifs - Inserts not included

REF.	MODÈLE MODEL	CARACTÉRISTIQUES SPECIFICATIONS	CONDITIONNEMENT PACKING	LIV/PCB
984904*	Pince Craft handle	ABS 	LS / Pegboardable	2/8



* Jusqu'à épuisement des stocks



















TAILLE RÉELLE
10 MM



«CROQ' MOTIFS» «Croq' motifs» inserts

Motifs interchangeables : les cassettes « Croq'motifs » s'insèrent dans la pince « Croq' perfo » et sont interchangeables pour réaliser de multiples découpes - «Croq'motifs» inserts fit into the «Croq'perfo» craft handle and are interchangeable

Corps ABS, poinçon en alliage - ABS body, alloy punch

REF.	TAILLE SIZE (MM)	MOTIF PATTERN	COLORIS COLORS	CONDITIONNEMENT PACKING	LIV/PCB
984418*	Ø 10			Vrac / Bulk	1/20
984428*	Ø 10			Vrac / Bulk	1/20
984438*	Ø 10			Vrac / Bulk	1/20
984458*	Ø 10			Vrac / Bulk	1/20
984478*	Ø 10			Vrac / Bulk	1/20
984488*	Ø 10			Vrac / Bulk	1/20
984498*	Ø 10			Vrac / Bulk	1/20
984978*	Ø 10			Vrac / Bulk	1/20

* Jusqu'à épuisement des stocks















TAILLE RÉELLE
14 MM



PERFORATEURS "LONG BRAS" Decorative long arm punchers

Des perfos spécialement étudiés pour perforer au milieu de la feuille. Système de rotation du motif pour l'incliner suivant vos envies - Decorative punchers specially designed to punch in the middle of the sheet. Rotative pattern so as to tilt it the way you want

Corps ABS, poinçon en alliage - ABS body, alloy punch

REF.	TAILLE SIZE (MM)	MOTIF PATTERN	COLORIS COLORS	CONDITIONNEMENT PACKING	LIV/PCB
986004*	Ø 14			LS / Pegboardable	1/60
986014*	Ø 14			LS / Pegboardable	1/60
986074*	Ø 14			LS / Pegboardable	1/60
986084*	Ø 14			LS / Pegboardable	1/60
986094*	Ø 14			LS / Pegboardable	1/60
986104*	Ø 14			LS / Pegboardable	1/60
986114*	Ø 14			LS / Pegboardable	1/60

* Jusqu'à épuisement des stocks

ACTIVITÉS MANUELLES ET CRÉATIVES

Manual and crafting activities

TAILLE RÉELLE
15/20 MM

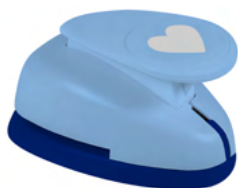

TAILLE RÉELLE
25 MM

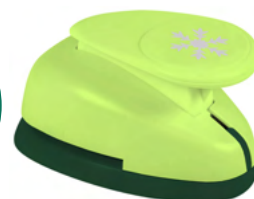

SET «DÉCO» 3 PIÈCES «Deco» set 3 pieces

Corps ABS, poinçon en alliage - ABS body, alloy punch

REF.	TAILLE SIZE (MM)	MOTIF PATTERN	COLORIS COLORS	CONDITIONNEMENT PACKING	LIV/PCB
APE800591	Ø 15/20			Boîte / Box	10/40

SET «DÉCO NOËL» 3 PIÈCES «Christmas deco» set 3 pieces

Corps ABS, poinçon en alliage - ABS body, alloy punch

REF.	TAILLE SIZE (MM)	MOTIF PATTERN	COLORIS COLORS	CONDITIONNEMENT PACKING	LIV/PCB
APE800391	Ø 25			Boîte / Box	10/30

SET «FANTAISIE» 10 PIÈCES «Fancy» set 10 pieces

REF.	TAILLE SIZE (MM)	MOTIF PATTERN	COLORIS COLORS	CONDITIONNEMENT PACKING	LIV/PCB
APE801593	Ø 20			Malette / Case	1/4
	Ø 40				
APE800993	Ø 25			Malette / Case	1/12

SET «NOËL» 6 PIÈCES «Christmas» set 6 pieces

Corps ABS, poinçon en alliage - ABS body, alloy punch

REF.	TAILLE SIZE (MM)	MOTIF PATTERN	COLORIS COLORS	CONDITIONNEMENT PACKING	LIV/PCB
APE800493	Ø 25			Malette / Case	6/12
	Ø 25				

SET «BORDURES & COINS» 5 PIÈCES «Borders & corners» set 5 pieces

Corps ABS, poinçon en alliage - ABS body, alloy punch

REF.	TAILLE SIZE (MM)	MOTIF PATTERN	COLORIS COLORS	CONDITIONNEMENT PACKING	LIV/PCB
5760.00*	Ø 25			Malette / Case	1/12

* Jusqu'à épuisement des stocks



PERFOS «BORDURE» À LEVIER Lever «border» punchers

Corps ABS, poinçon en alliage - ABS body, alloy punch

REF.	TAILLE SIZE (MM)	MOTIF PATTERN	COLORIS COLORS	CONDITIONNEMENT PACKING	UV/PCB
APE780062*	40			LS / Pegboardable	12/72
889438*	35 à 40			LS / Pegboardable	1/72

* Jusqu'à épuisement des stocks



PERFOS «COIN» «Corner» punchers

Corps ABS, poinçon en alliage - ABS body, alloy punch

REF.	TAILLE SIZE (MM)	MOTIF PATTERN	COLORIS COLORS	CONDITIONNEMENT PACKING	UV/PCB
B 5760.03*	25			LS / Pegboardable	12/96

* Jusqu'à épuisement des stocks

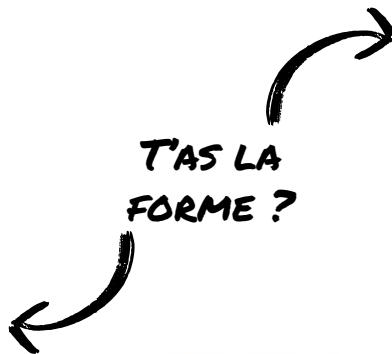

PERFO «BORDURE CONTINUE» «Continuous edge» punching set

Set de 3 pièces : perforateur à levier + règle + 1 cassette fleur - 3-pieces set :
lever-operated punch + ruler + 1 flower cassette

Corps ABS, poinçon en alliage - ABS body, alloy punch

REF.	TAILLE SIZE (MM)	MOTIF PATTERN	COLORIS COLORS	CONDITIONNEMENT PACKING	UV/PCB
889908*	50 à 25			LS / Pegboardable	1/12

* Jusqu'à épuisement des stocks



CASSETTE DE RECHANGE Spare cassette

Pour perfo «bordure continue» - For «continuous edge» punching
Corps ABS, poinçon en alliage - ABS body, alloy punch

REF.	TAILLE SIZE (MM)	MOTIF PATTERN	COLORIS COLORS	CONDITIONNEMENT PACKING	UV/PCB
889918*	50 à 25			LS / Pegboardable	1/72
889928*	50 à 25			LS / Pegboardable	1/72
889938*	50 à 25			LS / Pegboardable	1/72
889948*	50 à 25			LS / Pegboardable	1/72

* Jusqu'à épuisement des stocks

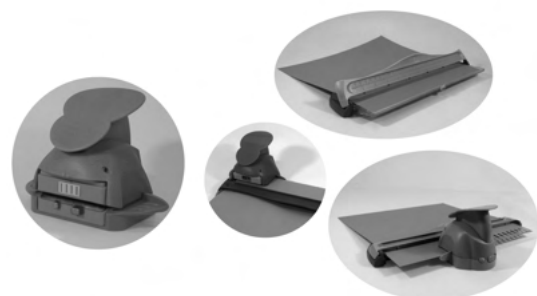

ACTIVITÉS MANUELLES ET CRÉATIVES

Manual and crafting activities

TAILLE RÉELLE
15/20 MM



TAILLE RÉELLE
20/25 MM



PERFOS «XS»

Corps ABS, poinçon en alliage - ABS body, alloy punch

REF.	TAILLE SIZE (MM)	MOTIF PATTERN	CONDITIONNEMENT PACKING	UV/PCB
APE150062*	Ø 15/20		LS / Pegboardable	1/192
880348*	Ø 15/20		LS / Pegboardable	1/192
880428*	Ø 15/20		LS / Pegboardable	1/192
880528*	Ø 15/20		LS / Pegboardable	1/192
880868*	Ø 15/20		LS / Pegboardable	1/192
880908*	Ø 15/20		LS / Pegboardable	1/192
880958*	Ø 15/20		LS / Pegboardable	1/192

* Jusqu'à épaulement des stocks



PERFOS «S»

Corps ABS, poinçon en alliage - ABS body, alloy punch

REF.	TAILLE SIZE (MM)	MOTIF PATTERN	CONDITIONNEMENT PACKING	UV/PCB
APE201162	Ø 20/25		LS / Pegboardable	1/96
APE200062	Ø 20/25		LS / Pegboardable	1/96
APE200162	Ø 20/25		LS / Pegboardable	1/96
APE200262	Ø 20/25		LS / Pegboardable	1/96
APE200962	Ø 20/25		LS / Pegboardable	1/96
APE200362	Ø 20/25		LS / Pegboardable	1/96
APE200462	Ø 20/25		LS / Pegboardable	1/96
APE201062	Ø 20/25		LS / Pegboardable	1/96
APE200662	Ø 20/25		LS / Pegboardable	1/96
APE200762	Ø 20/25		LS / Pegboardable	1/96

* Jusqu'à épaulement des stocks



PRÉSENTOIR PERFOS «S» Display punchers «S»

12 pcs par présentoir - 12 pcs per display

4 modèles assortis - 4 assorted patterns

Corps ABS, poinçon en alliage - ABS body, alloy punch

REF.	TAILLE SIZE (MM)	MOTIF PATTERN	COLORIS COLORS	CONDITIONNEMENT PACKING	UV/PCB
000040*	Ø 20/25			Présentoir / Display	1/10
000041*	Ø 20/25			Présentoir / Display	1/10

* Jusqu'à épaulement des stocks



TAILLE RÉELLE
38/40 MM



PERFOS «M»

Corps ABS, poinçon en alliage - ABS body, alloy punch
Avec réservoir à confettis - With confetti storage

REF.	TAILLE SIZE (MM)	MOTIF PATTERN	CONDITIONNEMENT PACKING	UV/PCB
APE400062	Ø 38/40		LS / Pegboardable	12/48
B 5738.11*	Ø 38/40		LS / Pegboardable	12/48
B 5738.30*	Ø 38/40		LS / Pegboardable	12/48
B 5738.69*	Ø 38/40		LS / Pegboardable	12/48
APE400162	Ø 38/40		LS / Pegboardable	12/48
APE400262*	Ø 38/40		LS / Pegboardable	12/48

* Jusqu'à épaisseur des stocks

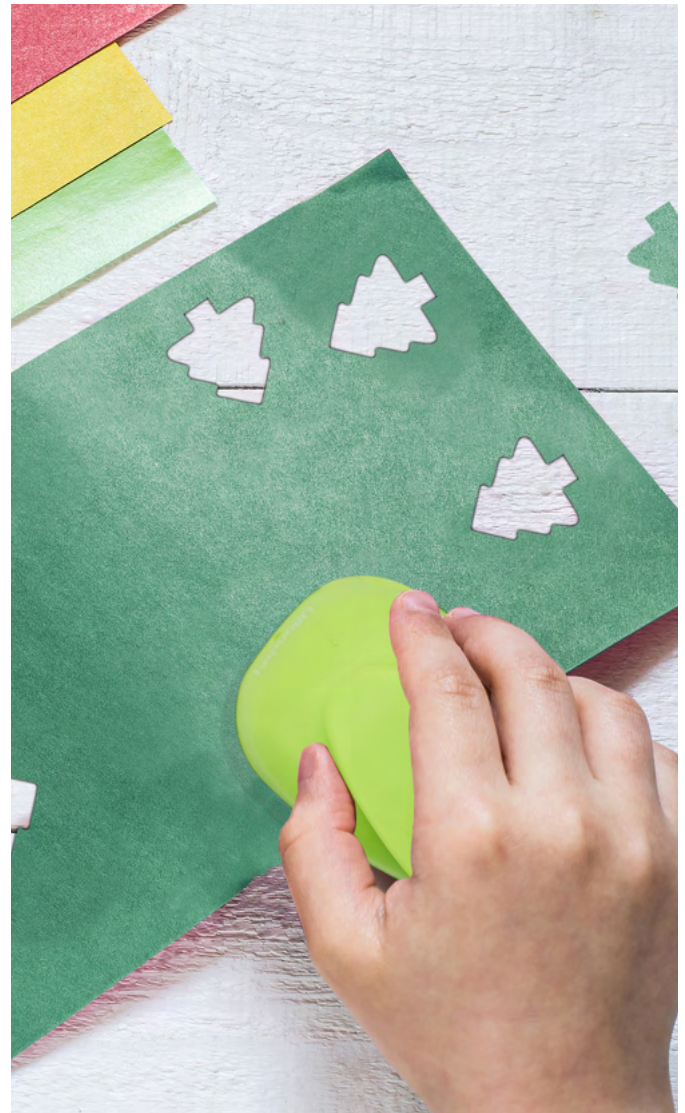

TAILLE RÉELLE
50/55 MM



PERFOS «L»

Corps ABS, poinçon en alliage - ABS body, alloy punch
Avec réservoir à confettis - With confetti storage

REF.	TAILLE SIZE (MM)	MOTIF PATTERN	CONDITIONNEMENT PACKING	UV/PCB
APE500062	Ø 50/55		LS / Pegboardable	1/36
APE500162	Ø 50/55		LS / Pegboardable	1/36
APE500362	Ø 50/55		LS / Pegboardable	1/36
885734*	Ø 50/55		LS / Pegboardable	1/48
APE500562	Ø 50/55		LS / Pegboardable	1/36
APE500662	Ø 50/55		LS / Pegboardable	1/36

* Jusqu'à épaisseur des stocks

ACTIVITÉS MANUELLES ET CRÉATIVES

Manual and crafting activities

TAILLE RÉELLE
70/76 MM



PERFOS « XL »

Corps ABS, poinçon en alliage - ABS body, alloy punch
Avec réservoir à confettis - With confetti storage

REF.	TAILLE SIZE (MM)	MOTIF PATTERN	CONDITIONNEMENT PACKING	UV/PCB
APE700462	Ø 70/76		LS / Pegboardable	3/18
APE700262	Ø 70/76		LS / Pegboardable	3/18
APE700162	Ø 70/76		LS / Pegboardable	3/18
APE700562	Ø 70/76		LS / Pegboardable	3/18
APE700362	Ø 70/76		LS / Pegboardable	3/18
APE700062	Ø 70/76		LS / Pegboardable	3/18
APE700662	Ø 70/76		LS / Pegboardable	3/18
B 5776.40*	Ø 70/76		LS / Pegboardable	3/18
B 5776.89*	Ø 70/76		LS / Pegboardable	3/18

* Jusqu'à épuisement des stocks





LA GREEN ATTITUDE Any tool for any day!*

CLASSEURS + CISEAUX
EN FIBRE DE BLÉ



COLLE
D'ORIGINE VÉGÉTALE +
TUBE 100% RECYCLÉ



SURLIGNEURS
CORPS EN BOUTEILLES
RECYCLÉES



RUBAN CORRECTEUR
CORPS ET TÊTE
EN PLASTIQUE RECYCLÉ















wonday.com

Suivez-nous sur



LEXIQUE

Glossary

PICTOGRAMMES / PICTOGRAM			
Unité de vente - Boîte carton Minimum quantity - Outer box	UV/PCB	Nombre de roues Number of wheels	
Coloris Color		Charge utile (kg) Loading capacity (kg)	
Coloris assortis Assorted colours		Fabrication européenne Made in Europe	
Diamètre de coupe maximum Maximum cutting diameter		Fabrication française Made in France	
Capacité d'agrafage Stapling capacity		Norme française French standard	
Nombre de marches Number of steps		Conformité Européenne European Conformity	
Tiroir Drawer		Apte au contact alimentaire Complies with food contact regulation	

MATIÈRES / MATERIAL			
Acrylonitrile Butadiène Styrène	ABS	Éthylène-acétate de vinyle	EVA
Polypropylène	PP	Polyéthylène	PE
Polystyrène	PS	Polyuréthane	PU
Polychlorure de vinyle	PVC	Polyamide	PA
Polytéréphtalate d'éthylène	PET	Polycarbonate	PC
Thermo-propylen rubber	TPR	Polypropylène à Orientation Biaxiale	BOPP
Butadiène-acrylonitrile	NBR		

ANY TOOL FOR ANY DAY*

* Complice du quotidien

Marques & modèles déposés - *Registered model & trademark*

Tous nos produits satisfont les normes en vigueur - *All our products meet the current standards*

Photos & coloris non contractuels - *Photos and colours are not contractual*

Jusqu'à épuisement des stocks - *While supplies last*

ÉQUIPEMENT

Fourniture

Qui dit confort au travail dit équipement 100% ergonomique, 100% pratique, 100% utile. Pour bouger, déplacer, ranger... tous nos outils sont bons ! Wonday développe des gammes de produits professionnels fixes ou pliants, renforcés ou anti-dérapants. Du dépôt au bureau, du véhicule à la maison... soyez mobiles ! Professionnel, passionné ou bricoleur du dimanche, il y en a pour tous les goûts. Wonday vous équipe à la hauteur de vos ambitions.

L'habit ne fait pas le moine, mais l'équipement est in-dis-pen-sable !



SERVICES GÉNÉRAUX

General services



COMMUNIQUER / COMMUNICATE



CHEVALET DE CONFÉRENCE Paperboard / Flipchart



Surface blanche, laquée, magnétique, inscriptible et effaçable à sec
White, lacquered, magnetic, writable and dry-wipe surface
3 pieds télescopiques en métal laqué, réglable de 115 à 186 cm - 3 telescopic legs stands in lacquered metal, adjustable height from 115 to 186 cm
Système porte-bloc en plastique à crochets coulissants - Plastic clamp with width-adjustable pad hooks
Livré sans bloc papier - Comes without paper pad
Auges en plastique - Plastic pen tray
Poids net : 6,10 kg - Net weight : 6,10 kg
Sans montage - Ready for use

REF.	DIM. (HXL CM)	CARACTÉRISTIQUES SPECIFICATIONS	CONDITIONNEMENT PACKING	UV/PCB
FSC400073	70 x 100	Aluminium Aluminum  	Vrac / Bulk	1/1

AFFICHE TON STYLE !





Livré avec 4 punaises
Supplied with 4 pins

TABLEAU LIÈGE CADRE BOIS Cork board wooden frame



Fond en liège naturel, résistant et auto-cicatrisant - Self-healing, resilient natural cork
Pour punaises et épingles - To be used with map pins and push pins
Montage à l'horizontal ou à la vertical - Can be mounted horizontally or vertically
Livré avec un kit de fixation - Wall fastening kit included
Pour le bureau et la maison - For office and home

REF.	DIM. (HXL CM)	CARACTÉRISTIQUES SPECIFICATIONS	CONDITIONNEMENT PACKING	UV/PCB
FSC300043	45 x 60	Liège-Bois Cork-Wood 	Vrac / Bulk	10/10
FSC300143	60 x 90	Liège-Bois Cork-Wood 	Vrac / Bulk	10/10





Coins arrondis en plastique
Plastic rounded corners

TABLEAU LIÈGE CADRE ALUMINIUM Cork board aluminum frame



Fond en liège naturel, résistant et auto-cicatrisant - Self-healing, resilient natural cork
Pour punaises et épingles - To be used with map pins and push pins
Montage à l'horizontal ou à la vertical - Can be mounted horizontally or vertically
Livré avec un kit de fixation - Wall fastening kit included
Pour le bureau et la maison - For office and home



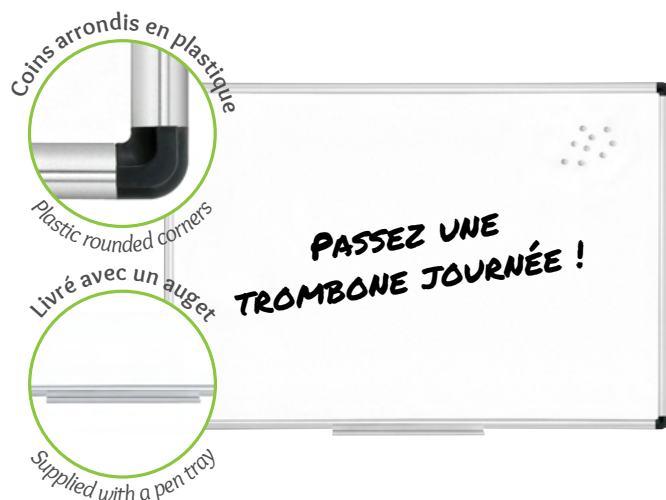



REF.	DIM. (HXL CM)	CARACTÉRISTIQUES SPECIFICATIONS	CONDITIONNEMENT PACKING	UV/PCB
FSC100083	45 x 60	Liège-Aluminium Cork-Aluminum 	Vrac / Bulk	3/3
FSC100183	60 x 90	Liège-Aluminium Cork-Aluminum 	Vrac / Bulk	3/3
FSC100283	90 x 120	Liège-Aluminium Cork-Aluminum 	Vrac / Bulk	3/3



TABLEAUX BLANCS MAGNÉTIQUES Magnetic whiteboards



Cadre en aluminium anodisé - Anodised aluminum frame
 Surface lisse, blanche et effaçable à sec - White smooth dry-wipe surface
 Pour marqueurs et aimants - To be used with markers and magnets
 Montage à l'horizontal ou à la vertical - Can be mounted horizontally or vertically
 Livré avec un kit de fixation - Wall fastening kit included
 Pour le bureau et la maison - For office and home

REF.	DIM. (HXL CM)	CARACTÉRISTIQUES SPECIFICATIONS	CONDITIONNEMENT PACKING	UV/PCB
FSC200073	45 x 60	Aluminium Aluminum  	Vrac / Bulk	3/3
FSC200173	60 x 90	Aluminium Aluminum  	Vrac / Bulk	3/3
FSC200273	90 x 120	Aluminium Aluminum  	Vrac / Bulk	3/3



TABLEAUX MURAUX ADHÉSIFS REPOSITIONNABLES Repositionable board wall stickers

Tableaux adhésifs en rouleau - Board wall stickers
 Se collent sur tous supports lisses et non poreux - To be stuck on any smooth and not porous supports
 Non aimanté - Non-magnetic

Pour marqueurs effaçables à sec - To be used with drywipe markers

REF.	DIM. (HXL CM)	CARACTÉRISTIQUES SPECIFICATIONS	CONDITIONNEMENT PACKING	UV/PCB
FSC000213	60 x 200		Vrac / Bulk	10/40



Pour craies (hors craies liquides) - To be used with chalks (except liquids chalks)

REF.	DIM. (HXL CM)	CARACTÉRISTIQUES SPECIFICATIONS	CONDITIONNEMENT PACKING	UV/PCB
FSC000013	60 x 200		Vrac / Bulk	10/40







REVÊTEMENT MURAL ADHÉSIF Adhesive wall covering

Revêtement tableau blanc mural souple ferreux adhésif pour aimants - Ferrous, adhesive and flexible wall covering for magnets
 Pour marqueurs effaçables à sec - To be used with drywipe markers
 Aimants non fournis - Magnets not supplied

REF.	DIM. (HXL CM)	CARACTÉRISTIQUES SPECIFICATIONS	CONDITIONNEMENT PACKING	UV/PCB
FSC000711	50 x 60	 	Vrac / Bulk	1/10



Double face craies (hors craies liquides) / marqueurs - Double side face chalks (except liquids chalks) / markers
 Pour aimanter vos documents - Magnetize your documents
 Aimants non fournis - Magnets not supplied

REF.	DIM. (HXL CM)	CARACTÉRISTIQUES SPECIFICATIONS	CONDITIONNEMENT PACKING	UV/PCB
FSC000311	48 x 58	 	Vrac / Bulk	1/10
FSC000411	58 x 98	 	Vrac / Bulk	1/10

SERVICES GÉNÉRAUX

General services



Corps en R-PS



PORTE-MARQUEURS MAGNÉTIQUES Magnetic pen holders

Aimant fort - Strong magnet
3 compartiments - 3 compartments

REF.	DIM. (HXL CM)	CARACTÉRISTIQUES SPECIFICATIONS	CONDITIONNEMENT PACKING	LIV/PCB
FSC800112	13 x 10 x 3,5	R-PS	LS / Pegboardable	12/72



Corps en R-ABS



Pour 4 marqueurs (non inclus) - For 4 markers (not included)

REF.	DIM. (HXL CM)	CARACTÉRISTIQUES SPECIFICATIONS	CONDITIONNEMENT PACKING	LIV/PCB
FSC800013	13,5 x 10 x 4	R-ABS	Vrac / Bulk	12/144

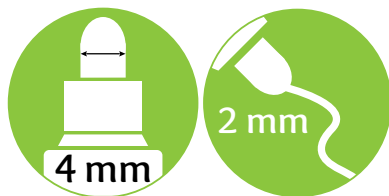

MARQUEURS EFFAÇABLES À SEC Assorted drywipe markers

Effaçables à sec - Drywipe markers
Corps bi-matière - Bi-material body
Boîte de 4 - Box of 4

REF.	DIM. (H MM)	CARACTÉRISTIQUES SPECIFICATIONS	CONDITIONNEMENT PACKING	LIV/PCB
FEC500192*	145	4 pcs	LS / Pegboardable	12/144

* Jusqu'à épuisement des stocks



MARQUEURS À CRAIE LIQUIDE Chalk Markers

Marqueurs à craie liquide - Chalk markers
Sans poussière - Dust less
Effaçable avec un chiffon humide - Wet-wipe erasable
Pour tous supports lisses et non poreux - For any smooth and not porous supports

REF.	DIM. (H MM)	CARACTÉRISTIQUES SPECIFICATIONS	CONDITIONNEMENT PACKING	LIV/PCB
FEC530031	130		Vrac / Bulk	12/144
FEC530132	130	4 pcs	LS / Pegboardable	12/72
FEC530232	130	4 pcs	LS / Pegboardable	12/72

STYLO POINTEUR LASER

Laser pointer

Portée jusqu'à maximum 100 m - Maximum 100 m reach

Livré avec 2 piles AAA - Comes with 2 AAA batteries

Avec clip - With clip



REF.	DIM. (HXL CM)	CARACTÉRISTIQUES SPECIFICATIONS	CONDITIONNEMENT PACKING	LIV/PCB
LP-160	-	Métal Metal	Boîte / Box	1/100

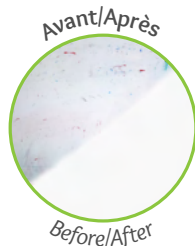

SPRAY NETTOYANT POUR TABLEAUX BLANCS

Whiteboard cleaning spray

À base de 80% d'eau - 80% water-based

Spray 250 ml - Spray 250 ml

REF.	QTÉ	CARACTÉRISTIQUES SPECIFICATIONS	CONDITIONNEMENT PACKING	LIV/PCB
FSC900031	250 ml	-	Vrac / Bulk	6/48

BROSSE BOIS POUR TABLEAUX NOIRS

Wooden blackboards eraser

Corps bois issu de forêts bien gérées certifiées - Wooden body comes from certified well-managed forests

Brosse 3 feutres - 3 felt brush

Non rechargeable - Not rechargeable



REF.	DIM. (HXL MM)	CARACTÉRISTIQUES SPECIFICATIONS	CONDITIONNEMENT PACKING	LIV/PCB
FSC600041	120 x 52	Bois Wood	Boîte / Box	10/100

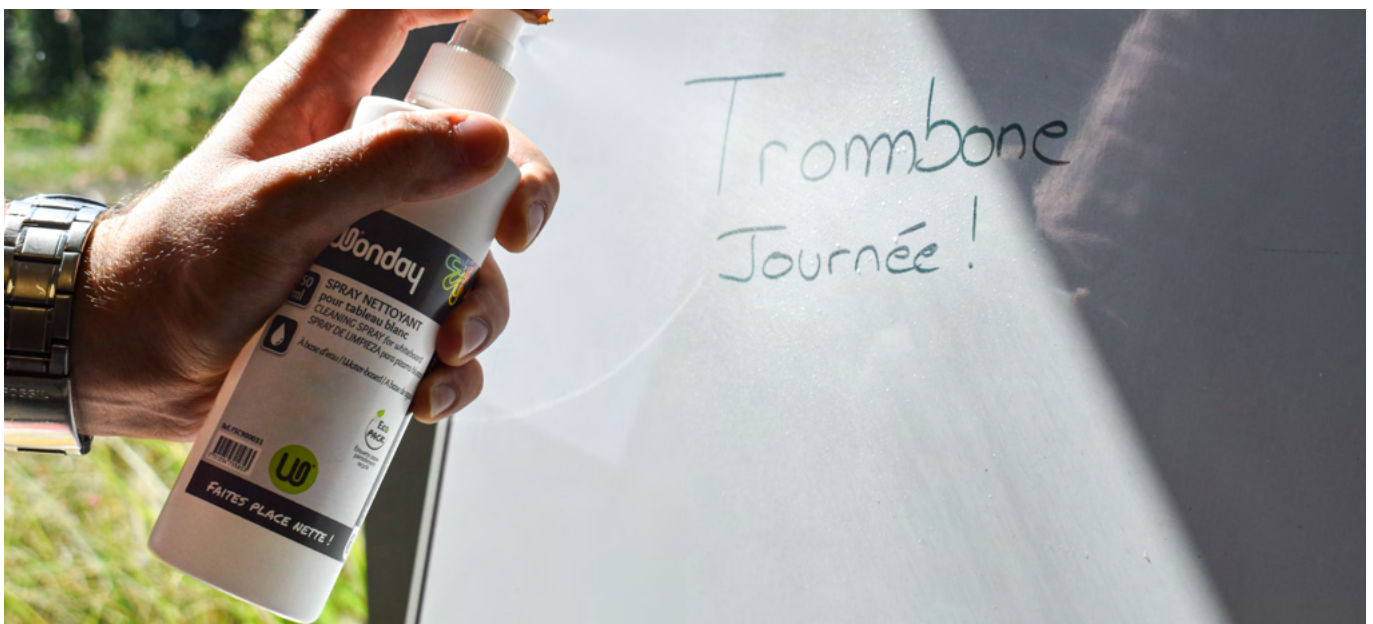

SERVICES GÉNÉRAUX

General services



Corps en R-ABS

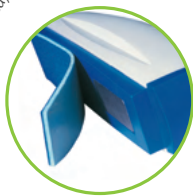

TURCIOPS

Coque R-ABS - R-ABS shell
Brosse feutrine - Felt brush
Magnétique - Magnetic
Pour tableaux blancs - For whiteboards
Compartment pour 2 marqueurs - 2 markers storage
FSC700022 : 6 feutrines rechargeables - 6 felts refill

REF.	DIM. (HxLxPMM)	CARACTÉRISTIQUES SPECIFICATIONS	CONDITIONNEMENT PACKING	UV/PCB
FSC650162	175 x 47 x 65	R-ABS	LS / Pegboardable	12/120
FSC700022		Recharges refills	LS / Pegboardable	12/120



BROSSE POUR TABLEAUX BLANCS - MAGNÉTIQUE

Whiteboards brush - Magnetic

Brosse magnétique livrée avec 2 marqueurs effaçables à sec - Whiteboard magnetic brush that comes with 2 drywipe markers

REF.	DIM. (HxLxPMM)	CARACTÉRISTIQUES SPECIFICATIONS	CONDITIONNEMENT PACKING	UV/PCB
FSC650062	45 x 60	PP	LS / Pegboardable	10/80



Corps en R-ABS

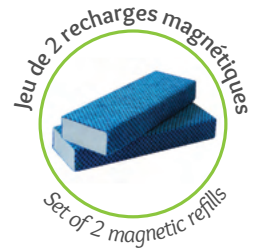

BROSSES POUR TABLEAUX BLANCS - MAGNÉTIQUE

Whiteboards brushes - Magnetic

Coque plastique R-ABS - R-ABS shell
Brosse velours ras - Short velvet brush
FSC700162 : 2 recharges magnétiques réversibles - 2 reversible magnetic refills

REF.	DIM. (HxLxPMM)	CARACTÉRISTIQUES SPECIFICATIONS	CONDITIONNEMENT PACKING	UV/PCB
FSC650462	40 x 147 x 55	R-ABS	LS / Pegboardable	12/96
FSC700162	22 x 150 x 48	Recharges refills	LS / Pegboardable	12/72



Corps en R-ABS

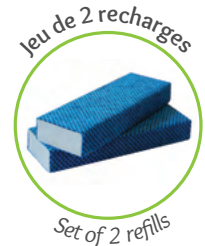
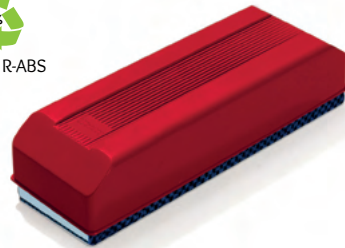

Coque plastique ABS - ABS plastic shell
Brosse velours ras - Short velvet board brush
FSC700162 : 2 recharges réversibles - 2 reversible refills

REF.	DIM. (HxLxPMM)	CARACTÉRISTIQUES SPECIFICATIONS	CONDITIONNEMENT PACKING	UV/PCB
FSC600362	147 x 40 x 55	ABS	LS / Pegboardable	12/144
FSC700122	22 x 150 x 48	Recharges refills	LS / Pegboardable	12/216



Coque plastique PP - Whiteboard brush with plastic shell
Brosse velours - Velvet board brush
Magnétique - Magnetic

REF.	DIM. (HxLxPMM)	CARACTÉRISTIQUES SPECIFICATIONS	CONDITIONNEMENT PACKING	UV/PCB
FSC650361	-	PP	Vrac / Bulk	12/240

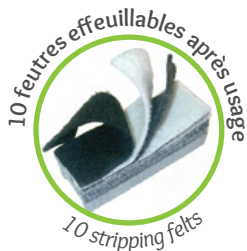

BROSSE POUR TABLEAUX BLANCS - NON MAGNÉTIQUE Whiteboards brush - Non magnetic

Coque plastique ABS - ABS plastic shell
Brosse feutrine effeuillable - Stripping felt brush

REF.	DIM. (HxLxPMM)	CARACTÉRISTIQUES SPECIFICATIONS	CONDITIONNEMENT PACKING	UV/PCB
FSC600261	41 x 145 x 53	ABS 	Boîte / Box	12/144



Corps bois issu de forêts bien gérées certifiées - Wooden body comes from certified well-managed forests
Brosse synthétique - Synthetic brush



REF.	DIM. (HxLxPMM)	CARACTÉRISTIQUES SPECIFICATIONS	CONDITIONNEMENT PACKING	UV/PCB
FSC600141	-	Bois Wood 	Vrac / Bulk	10/80



PROTÉGER / PROTECT

POCHETTE ÉTANCHE POUR SMARTPHONE Waterproof case for smartphone

Fonction tactile préservée - Touch screen OK
Déverrouillage du bouton home possible (sauf reconnaissance des empreintes) - "home" button unlocking OK
(Except fingerprint recognition)
Livré avec un cordon - Lanyard included
Dimensions : 170 x 105 mm / fenêtre : 140 x 80 mm - Dimensions: 170 x 105 mm / window: 140 x 80 mm

REF.	DIM. (HxL MM)	CARACTÉRISTIQUES SPECIFICATIONS	CONDITIONNEMENT PACKING	UV/PCB
GPN100062*	170 x 105	 	LS / Pegboardable	12/240

* Jusqu'à épuisement des stocks

IPX8 Conforme à la norme IPX8 - Comply with IPX8 standard
Produit testé : protège contre la submersion temporaire
(jusqu'à 1 m) pendant 30 minutes - Product tested : protects
against temporary flooding (until 1 m) within 30 minutes



SERVICES GÉNÉRAUX

General services

AFFICHER / SIGNAGE



CHEVALET PORTE-NOM

Table name badge

Plastique rigide transparent - Transparent rigid plastic
Livré avec un insert blanc - White insert included



REF.	DIM. (HXL MM)	CARACTÉRISTIQUES SPECIFICATIONS	CONDITIONNEMENT PACKING	LIV/PCB
GID600061	120 x 45	PS 	Vrac / Bulk	50/1000



BADGES À CLIP

Name badges with clip

Attache métal combinée clip + épingle - Combined metal plier + safety pin fastener
Plastique rigide transparent - Transparent rigid plastic
Livré avec un insert blanc - White insert included

REF.	DIM. (HXL MM)	CARACTÉRISTIQUES SPECIFICATIONS	CONDITIONNEMENT PACKING	LIV/PCB
GID200061	91 x 57	PVC 	Vrac / Bulk	50/1000
GID200162*	91 x 57	PVC  5 PCS	LS / Pegboardable	25/100

* Jusqu'à épuisement des stocks



BADGES À ÉPINGLE

Name badges with safety pin

Attache épingle métal - Metal pin fastener
Plastique rigide transparent - Transparent rigid plastic
Livré avec un insert blanc - White insert included



REF.	DIM. (HXL MM)	CARACTÉRISTIQUES SPECIFICATIONS	CONDITIONNEMENT PACKING	LIV/PCB
583460*	40 x 60	PVC 	Vrac / Bulk	100/2000

* Jusqu'à épuisement des stocks

BADGES À PINCE

Name badges with clip

Attache métal combinée pince + épingle - Combined metal clip + safety pin fastener
Plastique souple transparent - Transparent smooth plastic
Livré avec un insert photo - Photo insert included

REF.	DIM. (HXL MM)	CARACTÉRISTIQUES SPECIFICATIONS	CONDITIONNEMENT PACKING	LIV/PCB
GID300061	95 x 60	PVC 	Vrac / Bulk	50/1000
GID300161*	95 x 75	PVC 	Vrac / Bulk	50/1000

* Jusqu'à épuisement des stocks



Fond opaque - Opaque background

Livré avec un insert blanc - White insert included

REF.	DIM. (HXL MM)	CARACTÉRISTIQUES SPECIFICATIONS	CONDITIONNEMENT PACKING	LIV/PCB
GID300362*	95 x 75	PVC  5 PCS	LS / Pegboardable	25/100

* Jusqu'à épuisement des stocks



BADGES ÉVÉNEMENTIELS FORMAT A6 A6 format conference badges

Boîte de 10 badges événementiels + cordons - Set of 10 conference badges + lanyards
Livrés avec inserts blancs - White insert included
Cordons avec clip de sécurité et 2 mousquetons en métal - Lanyards with safety clip and 2 metal snap hooks

REF.	DIM. (HXL MM)	CARACTÉRISTIQUES SPECIFICATIONS	CONDITIONNEMENT PACKING	LIV/PCB
GID400061	148 x 105	PVC  	Vrac / Bulk	1/36



CORDONS À MOUSQUETON Lanyards with snap hook

Tour de cou avec mousqueton métal - Neck strap with snap hook
Clip de sécurité sur le lacet - Safety clip

REF.	DIM. (HXL MM)	CARACTÉRISTIQUES SPECIFICATIONS	CONDITIONNEMENT PACKING	LIV/PCB
GID900021	445x20	Nylon 	Vrac / Bulk	25/600



Tour de cou avec mousqueton métal - Neck strap with snap lock
Avec clip et boucle détachable - With clip and easily detachable badge
Livré avec 1 badge 100 x 60 mm - 100 x 60 mm badge included

REF.	DIM. (HXL MM)	CARACTÉRISTIQUES SPECIFICATIONS	CONDITIONNEMENT PACKING	LIV/PCB
GID400181	535x18	Nylon 	Vrac / Bulk	25/100



NE PASSEZ PLUS INCOGNITO !

SERVICES GÉNÉRAUX

General services

PORTE-BLOCS À PINCE / CLIPBOARDS



PORTE-BLOCS PVC PVC clipboards

Pince métal avec bords antiglisse - Metal clip with antislip corners
Oeillet de suspension rabattable - Folding hanging hole
Porte-stylo - Pen holder
Pour documents A4 - For A4 documents

REF.	DIM. (HXL CM)	CARACTÉRISTIQUES SPECIFICATIONS	CONDITIONNEMENT PACKING	UV/PCB
GPB140261	35,5 x 23,5	PVC	Vrac / Bulk	1/72
GPB140361	35,5 x 23,5	PVC	Vrac / Bulk	1/72
GPB140461	35,5 x 23,5	PVC	Vrac / Bulk	1/72
GPB140061	35 x 23	PVC	Vrac / Bulk	1/72



PORTE-BLOC ALUMINIUM MAGNÉTIQUE Magnetic aluminum clipboard

Pince métal avec bords antiglisse - Metal clip with antislip corners
Oeillet de suspension rabattable - Folding hanging hole
Bande magnétique au dos - Magnetic strip at the back
Pour documents A4 - For A4 documents

REF.	DIM. (HXL CM)	CARACTÉRISTIQUES SPECIFICATIONS	CONDITIONNEMENT PACKING	UV/PCB
GPB040071	31,8 x 22,7	Aluminium Aluminum	Vrac / Bulk	1/24



PORTE-BLOC BOIS MDF CERTIFIÉ Wooden certified clipboard

Pince métal avec bords antiglisse - Metal clip with antislip corners
Oeillet de suspension rabattable - Folding hanging hole
Pour documents A4 - For A4 documents

REF.	DIM. (HXL CM)	CARACTÉRISTIQUES SPECIFICATIONS	CONDITIONNEMENT PACKING	UV/PCB
GPB040441	31,5 x 22,7	MDF	Vrac / Bulk	1/60



PORTE-BLOC PS PS clipboard

Pince métal avec bords antiglisse - Metal clip with antislip corners
Oeillet de suspension rabattable - Folding hanging hole
Pour documents A4 - For A4 documents

REF.	DIM. (HXL CM)	CARACTÉRISTIQUES SPECIFICATIONS	CONDITIONNEMENT PACKING	UV/PCB
GPB040261	31,5 x 22,5	PS	Vrac / Bulk	1/72



PORTE-BLOC ALUMINIUM Aluminum clipboard

Pince métal avec bords antiglisse - Metal clip with antislip corners
Oeillet de suspension rabattable - Folding hanging hole
Pour documents A4 - For A4 documents

REF.	DIM. (HXL CM)	CARACTÉRISTIQUES SPECIFICATIONS	CONDITIONNEMENT PACKING	UV/PCB
GPB040171	31,8 x 22,7	Aluminium Aluminum	Vrac / Bulk	1/24



PORTE-BLOC À PINCE «JUMBO» «Jumbo» clipboard

Pince métal - Metal clip
Œillet de suspension - Hanging hole
Porte stylo intégré - Pen holder
Pour documents A4 - For A4 documents

REF.	DIM. (HXL CM)	CARACTÉRISTIQUES SPECIFICATIONS	CONDITIONNEMENT PACKING	LIV/PCB
GPB040361	35,5 x 23,5	PVC	Vrac / Bulk	1/40



PORTE-BLOC À RABAT Flap clipboard

Pince métal avec bords antiglisse - Metal clip with antislip corners
Œillet de suspension rabattable - Folding hanging hole
Pochette de rangement intérieur - Inside storage pocket
Pour documents A4 - For A4 documents

REF.	DIM. (HXL CM)	CARACTÉRISTIQUES SPECIFICATIONS	CONDITIONNEMENT PACKING	LIV/PCB
GPB140161	36,5 x 23,5 (fermé / closed)	PVC	Vrac / Bulk	1/36



**IDÉAL POUR LES
CHANTIERS EXTERIEURS**

PORTE-BLOC AVEC COMPARTIMENT DE RANGEMENT Clipboard with storage compartment

Plateau d'écriture solide et compartiment de rangement (feuille/stylo) - Solid writing tray and storage compartment (sheet/pen)
Poignée de transport - With handle
Double pince à clip intérieur plastique PP extérieur métal avec bords antiglisse - Double clip inside plastic PP outside metal with antislip corners
Pour documents A4 - For A4 documents
Livré vide - Comes empty

REF.	DIM. (HXLXP CM)	CARACTÉRISTIQUES SPECIFICATIONS	CONDITIONNEMENT PACKING	LIV/PCB
GPB240061	40 x 25,5 x 5	PP	Vrac / Bulk	1/12

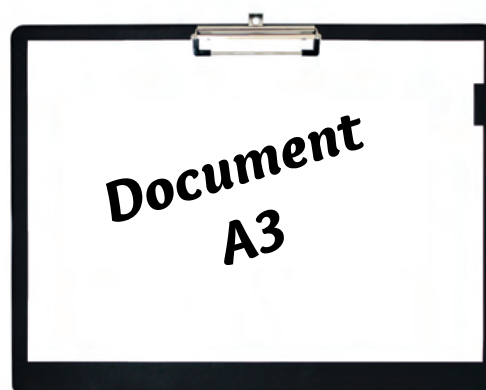

PORTE-BLOC A3 PAYSAGE Horizontal A3 clipboard

Pince métal avec bords antiglisse - Metal clip with antislip corners
Œillet de suspension rabattable - Folding hanging hole
Porte stylo intégré - Pen holder
Pour documents A3 paysage - For horizontal A3 documents

REF.	DIM. (HXL CM)	CARACTÉRISTIQUES SPECIFICATIONS	CONDITIONNEMENT PACKING	LIV/PCB
GPB030061	45 x 34	PVC	Vrac / Bulk	1/36

SERVICES GÉNÉRAUX

General services

CHEMISES & POCHETTES / FILING



CLASSEUR EN PP PP binder

Classeur polypro moyen format - Medium sized polypro binder
Transparent texturé - PP 0,8 mm d'épaisseur - Textured transparent - PP 0.8 mm thick
4 anneaux métal en D, diam 25 mm, hauteur 16 mm, espacé tous les 80mm - 4 metal D-rings, diam 25 mm, height 16 mm, spaced every 80mm
Rivets nickelés - Nickel-plated rivets
Pour feuilles A4, intercalaires et pochettes - For A4 sheets, dividers and pockets

REF.	DIM. (HXL CM)	CARACTÉRISTIQUES SPECIFICATIONS	CONDITIONNEMENT PACKING	UV/PCB
FCM700061*	32 x 52,5 (Ouvert/Open)	PP	Vrac / Bulk	1/48

* Jusqu'à épaisseur des stocks



POCHETTE PERFORÉE À SCRATCH Punched pocket with a scratch

Pochette en PP épaisseur 20/100ème - Made with PP thickness 20/100ths
Fermeture à scratch - Scratch fastening
Perforation 11 trous - 11 holes
Porte-cartes de visite inclus - Business card holder included

REF.	DIM. (HXL CM)	CARACTÉRISTIQUES SPECIFICATIONS	CONDITIONNEMENT PACKING	UV/PCB
FCM200061	23,1 x 31,2	PP	Vrac / Bulk	10/240



CHEMISES 3 RABATS EN PP PP 3 flaps folders

3 rabats - 3 flaps
Épaisseur 0,4 mm - Thickness 0,4 mm
Fermetures par élastiques - Elastic closures
Pour documents A4 - For A4 documents

REF.	DIM. (HXL CM)	CARACTÉRISTIQUES SPECIFICATIONS	CONDITIONNEMENT PACKING	UV/PCB
FCM400061*	32 x 24	PP	Vrac / Bulk	10/120
FCM400161*	32 x 24	PP	Vrac / Bulk	10/120
FCM400261*	32 x 24	PP	Vrac / Bulk	10/120

* Jusqu'à épaisseur des stocks



CLASSEURS SOUPLES

Flexible binders



Classeur fabriqué à partir de PP vierge à 75% et de fibre de blé à 25%

Binder made from 75% virgin PP and 25% wheat fiber

Dos 37 mm - 37 mm back

4 anneaux métal Ø 27 mm - 4 metal rings Ø 27 mm

Pour feuilles A4, intercalaires et pochettes - For A4 sheets, dividers and pockets

REF.	DIM. (HXL CM)	CARACTÉRISTIQUES SPECIFICATIONS	CONDITIONNEMENT PACKING	UV/PCB
FCM700101	31,5 x 52 (Ouvert/Open)	75% PP vierge-25% fibre de blé 75% virgin PP-25% wheat fiber	 Vrac / Bulk	1/36
FCM700201	31,5 x 52 (Ouvert/Open)	75% PP vierge-25% fibre de blé 75% virgin PP-25% wheat fiber	 Vrac / Bulk	1/36

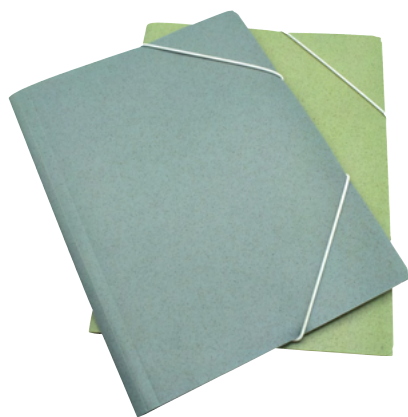

CHEMISES 3 RABATS

3 flaps folders

Fabriquées à partir de PP vierge à 75% et de fibre de blé à 25%



Made from 75% virgin PP and 25% wheat fiber

3 rabats - 3 flaps

Épaisseur 0,4 mm - Thickness 0,4 mm

Fermetures par élastiques - Elastic closure

Pour documents A4 - For A4 documents

REF.	DIM. (HXL CM)	CARACTÉRISTIQUES SPECIFICATIONS	CONDITIONNEMENT PACKING	UV/PCB
FCM400401	31,8 x 24	75% PP vierge-25% fibre de blé 75% virgin PP-25% wheat fiber	 Vrac / Bulk	10/120
FCM400501	31,8 x 24	75% PP vierge-25% fibre de blé 75% virgin PP-25% wheat fiber	 Vrac / Bulk	10/120



Pochette en R-PP



CHEMISES 3 RABATS

3 flaps folders



Fabriquées en R-PP Recyclés à 100% - Made from 100% recycled R-PP

3 rabats - 3 flaps

Épaisseur 0,4 mm - Thickness 0,4 mm

Fermetures par élastiques - Elastic closure

Pour documents A4 - For A4 documents

REF.	DIM. (HXL CM)	CARACTÉRISTIQUES SPECIFICATIONS	CONDITIONNEMENT PACKING	UV/PCB
FCM400601	31,8 x 24	R-PP 	Vrac / Bulk	10/120
FCM400701	31,8 x 24	R-PP 	Vrac / Bulk	10/120

SERVICES GÉNÉRAUX

General services



Pochette en R-PP

POCHETTES POLYPRO RECYCLÉ SEMI-TRANSPARENTES

Semi-transparent R-PP wallets

Épaisseur 0,2 mm - Thickness 0,2 mm

Fermeture à scratch - Velcro closure

Pour documents A4 - For A4 documents

REF.	DIM. (HXL CM)	CARACTÉRISTIQUES SPECIFICATIONS	CONDITIONNEMENT PACKING	LIV/PCB
FCM202001	335 x 240	R-PP	Vrac / Bulk	10/240
FCM202101	335 x 240	R-PP	Vrac / Bulk	10/240



POCHETTES POLYPRO SEMI-TRANSPARENTES

Semi-transparent PP wallets

Pochettes en PP épaisseur 20/100ème - Wallets made with PP thickness 20/100ths

Fermeture à scratch - Scratch fastening

3 tailles assorties - 3 assorted sizes

REF.	DIM. (HXL CM)	CARACTÉRISTIQUES SPECIFICATIONS	CONDITIONNEMENT PACKING	LIV/PCB
FCM900093*	3 tailles assorties 3 assorted size	PP 150 PCS	Présentoir / Display	1/2
FCM200501	12,5 x 22,2	PP	Vrac / Bulk	10/960
FCM200601	12,5 x 22,2	PP	Vrac / Bulk	10/960
FCM200701	12,5 x 22,2	PP	Vrac / Bulk	10/960
FCM200801	12,5 x 22,2	PP	Vrac / Bulk	10/960
FCM200901	12,5 x 22,2	PP	Vrac / Bulk	10/960
FCM201001	17,9 x 24,9	PP	Vrac / Bulk	10/480
FCM201101	17,9 x 24,9	PP	Vrac / Bulk	10/480
FCM201201	17,9 x 24,9	PP	Vrac / Bulk	10/480
FCM201301	17,9 x 24,9	PP	Vrac / Bulk	10/480
FCM201401	17,9 x 24,9	PP	Vrac / Bulk	10/480
FCM201501	23,7 x 33,3	PP	Vrac / Bulk	10/240
FCM201601	23,7 x 33,3	PP	Vrac / Bulk	10/240
FCM201701	23,7 x 33,3	PP	Vrac / Bulk	10/240
FCM201801	23,7 x 33,3	PP	Vrac / Bulk	10/240
FCM201901	23,7 x 33,3	PP	Vrac / Bulk	10/240



**RANGÉZ VOS
P'TITS PAPIERS !**

* Jusqu'à épuisement des stocks

POCHETTES POLYPRO





PP document wallets



Pochettes en PP épaisseur 20/100ème - Made with PP thickness 20/100ths



Fermeture à bouton pression - Snap button closure

Fermeture à scratch - Scratch fastening

REF.	DIM. (HXL CM)	CARACTÉRISTIQUES SPECIFICATIONS	CONDITIONNEMENT PACKING	UV/PCB
FCM200461	6,2 x 10,5	PP 	Vrac / Bulk	10/960
FCM200161	12,5 x 22	PP 	Vrac / Bulk	10/960
FCM200261	17,9 x 24,7	PP 	Vrac / Bulk	10/480
FCM200361	23,8 x 33,2	PP 	Vrac / Bulk	10/240

REF.	DIM. (HXL CM)	CARACTÉRISTIQUES SPECIFICATIONS	CONDITIONNEMENT PACKING	UV/PCB
FCM300061*	12,5 x 21,9	PP 	Vrac / Bulk	10/480
FCM300161*	17,9 x 24,7	PP 	Vrac / Bulk	10/360
FCM300261*	23,7 x 33,2	PP 	Vrac / Bulk	10/240

* Jusqu'à épuisement des stocks



POCHETTES ZIPPÉES

Zipper bags

Pochettes zippées PVC renforcé - Zipper bags in reinforced PVC

Semi-transparentes - Semi-transparent

Pour le courrier, les documents importants ou pour servir de trousse en déplacement - For mail, important documents or for using as a travel case

Couture renforcée - Reinforced sewing

POCHETTES ZIPPÉES COULEUR - QUALITÉ SUPÉRIEURE

Coloured zipper bags - High quality







Pochettes zippées PVC renforcé - Zipper bags in reinforced PVC





Zip qualité supérieur - High quality Zipper

Semi-transparentes - Semi-transparent

Pour le courrier, les documents importants ou pour servir de trousse en déplacement - For mail, important documents or for using as a travel case

Couture renforcée - Reinforced sewing

REF.	DIM. (HXL CM)	CARACTÉRISTIQUES SPECIFICATIONS	CONDITIONNEMENT PACKING	UV/PCB
FCM100061	13 x 17	PVC 	Vrac / Bulk	10/480
FCM100161	17,5 x 21	PVC 	Vrac / Bulk	10/480
FCM100261	19 x 25	PVC 	Vrac / Bulk	10/480
FCM100361	22 x 29	PVC 	Vrac / Bulk	10/240
FCM100461	26 x 34,5	PVC 	Vrac / Bulk	5/240
FCM100561	30 x 40	PVC 	Vrac / Bulk	5/240

REF.	DIM. (HXL CM)	CARACTÉRISTIQUES SPECIFICATIONS	CONDITIONNEMENT PACKING	UV/PCB
FCM150061	13 x 17	PVC 	Vrac / Bulk	10/480
FCM150161	17,5 x 21	PVC 	Vrac / Bulk	10/480
FCM150261*	19 x 25	PVC 	Vrac / Bulk	10/480
FCM150361	22 x 29	PVC 	Vrac / Bulk	10/240
FCM150661*	23 x 13	PVC 	Vrac / Bulk	10/480
FCM150461*	26 x 34,5	PVC 	Vrac / Bulk	5/240
FCM150561	30 x 40	PVC 	Vrac / Bulk	5/240

* Jusqu'à épuisement des stocks



POCHETTES COINS

Pour tous documents
Adhésives

REF.	DIMENSIONS (MM)	CARACTÉRISTIQUES SPECIFICATIONS	CONDITIONNEMENT PACKING	LIV/PCB
P11107	75 x 75	PP Transparent	Sachet / Bag (x12)	1/120
P11147	100 x 100	PP Transparent	Sachet / Bag (x10)	1/120
P11189	170 x 170	PP Transparent	Sachet / Bag (x6)	10/60



PORTE-CARTES

Pour cartes de visite
P10108 - P10168 - P10141PP - P10161PP : Adhésifs

REF.	DIMENSIONS (MM)	CARACTÉRISTIQUES SPECIFICATIONS	CONDITIONNEMENT PACKING	LIV/PCB
P10101PP*	60 x 95	PP Transparent	Boîte / Box (x100)	1/10
P10108	60 x 95	PP Transparent	Sachet / Bag (x10)	1/120
P10168	105 x 60	PP Transparent	Sachet / Bag (x10)	10/120
P10141PP	95 x 60	PP Transparent	Boîte / Box (x100)	1/10
P10161PP	105 x 60	PP Transparent	Boîte / Box (x100)	1/10

* Jusqu'à épaisseur des stocks



POCHETTES ENCARTS

Adhésives

REF.	DIMENSIONS (MM)	CARACTÉRISTIQUES SPECIFICATIONS	CONDITIONNEMENT PACKING	LIV/PCB
P13101PP*	A4 derrière 210 x 100 mm devant	PP Transparent	Boîte / Box (x100)	1/12
P15102	A4	PP Transparent	Sachet / Bag (x25)	1/12
P15109	A4	PP Transparent	Sachet / Bag (x10)	1/60
P15159*	A5	PP Transparent	Sachet / Bag (x10)	1/60

* Jusqu'à épaisseur des stocks



POCHETTES RANGEMENT CD/MULTIMÉDIA

Pour CD / supports multimédia
Avec rabat
Adhésives

REF.	DIMENSIONS (MM)	CARACTÉRISTIQUES SPECIFICATIONS	CONDITIONNEMENT PACKING	LIV/PCB
P14309*	126 x 126	PP Transparent	Sachet / Bag (x6)	10/120

* Jusqu'à épaisseur des stocks



PORTE-ÉTIQUETTES

Pour classer
Adhésifs

REF.	DIMENSIONS (MM)	CARACTÉRISTIQUES SPECIFICATIONS	CONDITIONNEMENT PACKING	LIV/PCB
P16107	19 x 75	PP Transparent	Sachet / Bag (x12)	10/120
P16147	25 x 75	PP Transparent	Sachet / Bag (x12)	10/120
P16157	35 x 75	PP Transparent	Sachet / Bag (x12)	10/120
P16179	46 x 75	PP Transparent	Sachet / Bag (x6)	10/120
P16189	55 x 102	PP Transparent	Sachet / Bag (x6)	10/120
P16227	25 x 102	PP Transparent	Sachet / Bag (x12)	10/120
P16259*	62 x 150	PP Transparent	Sachet / Bag (x6)	10/120

* Jusqu'à épuisement des stocks

BANDES PERFORÉES

Pour reliure à anneaux
Adhésives



REF.	DIMENSIONS (MM)	CARACTÉRISTIQUES SPECIFICATIONS	CONDITIONNEMENT PACKING	LIV/PCB
P30102	A4	PP / Polyester Transparent	Sachet / Bag (x25)	10/120
P30105	A4	PP / Polyester Transparent	Sachet / Bag (x50)	10/120

PASTILLES ADHÉSIVES

Double faces

REF.	DIMENSIONS (MM)	CARACTÉRISTIQUES SPECIFICATIONS	CONDITIONNEMENT PACKING	LIV/PCB
P60500		Transparent	Boîte / Box (x500)	20/120



ONGLETS

Pour indexation
Adhésifs

REF.	DIMENSIONS (MM)	CARACTÉRISTIQUES SPECIFICATIONS	CONDITIONNEMENT PACKING	LIV/PCB
P40100	12 x 25	Polyester Blanc transparent	Sachet / Bag (x72)	10/120
P40150	12 x 25	Polyester Coloris assortis transparent	Sachet / Bag (x72)	10/120
P40200	12 x 40	Polyester Blanc transparent	Sachet / Bag (x48)	10/120
P40250	12 x 40	Polyester Coloris assortis transparent	Sachet / Bag (x48)	10/120



PLASTIFICATION À FROID

REF.	DIMENSIONS (MM)	CARACTÉRISTIQUES SPECIFICATIONS	CONDITIONNEMENT PACKING	LIV/PCB
P2010001*	54 x 86	PP / Polyester Transparent	Boîte / Box (x2000)	1/1
P20121*	66 x 100	PP / Polyester Transparent	Boîte / Box (x100)	1/24

* Jusqu'à épuisement des stocks



FEUILLES PLASTIFIÉES

200 microns

REF.	DIMENSIONS (MM)	CARACTÉRISTIQUES SPECIFICATIONS	CONDITIONNEMENT PACKING	LIV/PCB
P20128	66 x 100	PP / Polyester Transparent	Sachet / Bag (x10)	10/120



COINS-PHOTOS

Adhésifs

REF.	DIMENSIONS (MM)	CARACTÉRISTIQUES SPECIFICATIONS	CONDITIONNEMENT PACKING	LIV/PCB
P63250	10 x 10	PP Transparent	Boîte / Box (x250)	20/160









NOTES REPOSITIONNABLES / REPOSITIONABLE STICKY NOTES



NOTES REPOSITIONNABLES Repositionable sticky notes

Bloc notes repositionnables - *Repositionable sticky notes*

REF.	DIM. (HXL MM)	CARACTÉRISTIQUES SPECIFICATIONS	CONDITIONNEMENT PACKING	UV/PCB
FPP100301	75 x 75	Bloc de 100 feuilles 100 sheets pad	 Vrac / Bulk	12/192
FPP100401	75 x 125	Bloc de 100 feuilles 100 sheets pad	 Vrac / Bulk	12/144
FPP100092	75 x 75	Bloc de 320 feuilles 320 sheets pad	 LS / Pegboardable	12/48
FPP100601	75 x 75	Bloc de 320 feuilles 320 sheets pad	 Vrac / Bulk	8/48
FPP100501*	40 x 50	100 feuilles x 12 blocs 12 pads of 100 sheets	 Vrac / Bulk	12/48
FPP100701	40 x 50	100 feuilles - lot de 4 x 3 blocs Set of 4 x 3 pads of 100 sheets	 Vrac / Bulk	12/48







* Jusqu'à épuisement des stocks

C'EST OÙ TU VEUX !



DÉVIDOIRS DE NOTES REPOSITIONNABLES Rolling sticky notes

Rouleau dévidoir 6 cm x 10 m - *6 cm x 10 m rolling notes*
Notes repositionnables - *Repositionable sticky notes*

REF.	DIM. (H X L)	CARACTÉRISTIQUES SPECIFICATIONS	CONDITIONNEMENT PACKING	UV/PCB
FPP400012	6 cm x 10 m	-	 LS / Pegboardable	12/48
FPP400112	6 cm x 10 m	-	 LS / Pegboardable	12/48
572025*	6 cm x 10 m	-	 LS / Pegboardable	12/48
900109	6 cm x 10 m	-	 Boîte / Box	1/40
900175	6 cm x 10 m	-	 Vrac / Bulk	1/60
900176	6 cm x 10 m	-	 Vrac / Bulk	1/60
FPP400411	6 cm x 10 m	10 recharges 10 refills	 Vrac / Bulk	1/10

* Jusqu'à épuisement des stocks



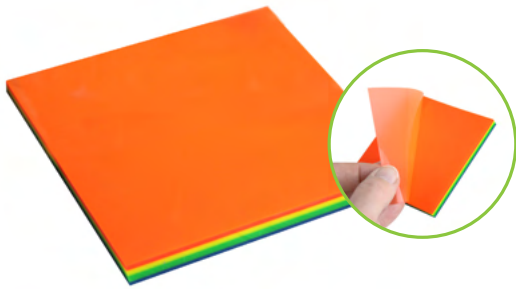

NOTES REPOSITIONNABLES SEMI-TRANSPARENTES Semi-transparent repositionable sticky notes

100 feuilles en PET - 100 PET sheets
4 coloris fluo assortis - 4 assorted neon colours

REF.	DIM. (HXL MM)	CARACTÉRISTIQUES SPECIFICATIONS	CONDITIONNEMENT PACKING	LV/PCB
FPP100192	75 x 75	Bloc de 100 feuilles 100 sheets pads	 LS / Pegboardable	12/144



MARQUE-PAGES SEMI-RIGIDES Semi-rigid page markers



Marque-pages repositionnables semi-rigides - Semi-rigid repositionable page makers
Règle transparente perforée - Transparent punched ruler
Idéal pour le classement - Ideal for file classification

REF.	DIM. (HXL MM)	CARACTÉRISTIQUES SPECIFICATIONS	CONDITIONNEMENT PACKING	LV/PCB
FPP300012	38 x 51	18 feuilles (6x3 pcs) 18 sheets (6x3 pcs)	 LS / Pegboardable	24/480





MARQUE-PAGES REPOSITIONNABLES Repositionable page markers

Support plastique - Plastic holder
Marque-pages repositionnables étroits 12 x 44 mm - 12 x 44 mm repositionable page markers
5 coloris fluo assortis - 5 assorted neon colours
100 index - 100 page markers

REF.	DIM. (HXL MM)	CARACTÉRISTIQUES SPECIFICATIONS	CONDITIONNEMENT PACKING	LV/PCB
FPP300112	12 x 44	5 x 20 feuilles 5 x 20 sheets	 LS / Pegboardable	24/1152
FPP300212	12 x 44	5 x 20 feuilles 5 x 20 sheets	 LS / Pegboardable	24/1152



Marque-pages repositionnables - Repositionable page markers
5 coloris fluo assortis - 5 assorted neon colours
Support distributeur plastique de 100 index - Plastic holder dispenser of 100 page markers

REF.	DIM. (HXL MM)	CARACTÉRISTIQUES SPECIFICATIONS	CONDITIONNEMENT PACKING	LV/PCB
FPP200212	20 x 44	5 x 20 feuilles 5 x 20 sheets	 LS / Pegboardable	24/576
FPP200112	20 x 44	5 x 20 feuilles 5 x 20 sheets	 LS / Pegboardable	24/576

SERVICES GÉNÉRAUX

General services

ACCESSOIRES DE BUREAU / OFFICE ACCESSORIES



SOCLE BOIS VERNI POUR ÉPHÉMÉRIDE
Varnished wood calendar holder

2 arceaux métal - 2 metal hooks
Emplacement support crayon - Space / support for pencil
Bloc éphéméride non inclus - Calendar not included

REF.	DIM. (HxLxPMM)	CARACTÉRISTIQUES SPECIFICATIONS	CONDITIONNEMENT PACKING	LIV/PCB
FAB100041	35 x 205 x 145	Bois Wood	Vrac / Bulk	10/60



SOCLES PLASTIQUE POUR ÉPHÉMÉRIDE
Plastic desk calendar holders

2 arceaux plastique PP - 2 PP plastic hooks
Emplacement support crayon - Space / support for pencil
Bloc éphéméride non inclus - Calendar not included

REF.	DIM. (HxLxPMM)	CARACTÉRISTIQUES SPECIFICATIONS	CONDITIONNEMENT PACKING	LIV/PCB
FAB100261	30 x 195 x 145	ABS recyclé Recycled ABS	Vrac / Bulk	1/60
FAB100161	30 x 195 x 145	SAN	Vrac / Bulk	1/60



SOCLE PS POUR ÉPHÉMÉRIDE
PS desk calendar holder

2 arceaux plastique PP - 2 PP plastic hooks
Emplacement pour crayon et bloc mémo - Space for pencil and memo pad
Bloc éphéméride non inclus - Calendar not included

REF.	DIM. (HxLxPMM)	CARACTÉRISTIQUES SPECIFICATIONS	CONDITIONNEMENT PACKING	LIV/PCB
FAB100461	33 x 205 x 165	PS	Vrac / Bulk	1/54



SOCLE PS POUR ÉPHÉMÉRIDE
PS desk calendar holder

2 arceaux métal - 2 metal hooks
5 compartiments de rangement - 5 storage compartments
Bloc éphéméride non inclus - Calendar not included

REF.	DIM. (HxLxPMM)	CARACTÉRISTIQUES SPECIFICATIONS	CONDITIONNEMENT PACKING	LIV/PCB
FAB100561	90 x 223 x 200	PS	Vrac / Bulk	1/12



SUPPORTS MULTI-CASES

Desk organisers



Matière plastique résistante - Resistant plastic material

1 emplacement mécanisme «dévidoir» pour adhésif - 1 space / mechanism for tape dispenser

1 pot à crayons amovible - 1 removable pencil cup

3 emplacements pour des accessoires de bureau - 3 spaces for office stationery

1 emplacement pour papiers et règles - 1 space for papers and rulers

Livré sans accessoires - Accessories not included

REF.	DIM. (HXLXP MM)	CARACTÉRISTIQUES SPECIFICATIONS	CONDITIONNEMENT PACKING	LV/PCB
4121A	80x238x 198	PS	Boîte / Box	1/10
4121N	80x238x 198	PS	Boîte / Box	1/10



POT ROTATIF

Rotary pencil pot

7 compartiments de rangement - 7 storage compartments

REF.	DIM. (HXL MM)	CARACTÉRISTIQUES SPECIFICATIONS	CONDITIONNEMENT PACKING	LV/PCB
FAB280003	Ø 11 - h 131	PP	Vrac / Bulk	12/36



POT À CRAYONS PLASTIQUE

Plastic pencil pot

REF.	DIM. (HXL MM)	CARACTÉRISTIQUES SPECIFICATIONS	CONDITIONNEMENT PACKING	LV/PCB
FAB200601	Ø 70 - h 89	ABS	Vrac / Bulk	10/200

L'UNION FAIT LA FORCE !



POTS À CRAYONS PLASTIQUE

Plastic pencil pots

REF.	DIM. (HXL MM)	CARACTÉRISTIQUES SPECIFICATIONS	CONDITIONNEMENT PACKING	LV/PCB
FAB200591	Ø 67 - h 88	PP	Vrac / Bulk	1/20
FAB200001	Ø 67 - h 88	PP	Vrac / Bulk	10/200
FAB200101	Ø 67 - h 88	PP	Vrac / Bulk	10/200
FAB200201	Ø 67 - h 88	PP	Vrac / Bulk	10/200
FAB200301*	Ø 67 - h 88	PP	Vrac / Bulk	10/200
FAB200401	Ø 67 - h 88	PP	Vrac / Bulk	10/200

* Jusqu'à épuisement des stocks

SERVICES GÉNÉRAUX

General services



1 2 3 4 5 6



8 MARS 2024

DATEUR - NUMÉROTEUR Date stamp - Number stamp

Bandes caoutchouc - Rubber strips

Encrage manuel - Manual inking

S'utilise avec un tampon encreur - To be used with inking pad

Numéroteur : avec sigle .- / - Number stamp : includes .- / characters

REF.	DIM.	CARACTÉRISTIQUES SPECIFICATIONS	CONDITIONNEMENT PACKING	UV/PCB
FTP100083	Dateur Date stamp 5 mm	Plastique-caoutchouc Plastic-caoutchouc	Boîte / Box	6/240
FTP100181*	Numéroteur Number stamp 4 mm	Plastique-caoutchouc Plastic-caoutchouc	Boîte / Box	6/240

* Jusqu'à épuisement des stocks



**RETROUVEZ
NOS PAPIERS CARBONE
PAGE 140**



PORTE-TAMPONS Stamp racks

Support et base métal lestée - Metal weighted base and support

2 niveaux - 2 levels

16 emplacements - 16 pitches

REF.	DIM. (HXL MM)	CARACTÉRISTIQUES SPECIFICATIONS	CONDITIONNEMENT PACKING	UV/PCB
584901*	-	Plastique Plastic	Boîte / Box	1/72

* Jusqu'à épuisement des stocks



TAMPONS ENCREURS ET BOUTEILLES D'ENCRE Inking pads and ink bottles

Boîtier plastique - Plastic box

MODÈLE MODEL	REF.	DIM. (HXL MM)	CARACTÉRISTIQUES SPECIFICATIONS	CONDITIONNEMENT PACKING	UV/PCB
Tampon Pad	FTP200001	100 x 75	Plastique Plastic	Vrac / Bulk	10/240
	FTP200101	100 x 75	Plastique Plastic	Vrac / Bulk	10/240
	FTP200201	100 x 75	Plastique Plastic	Vrac / Bulk	10/240
Bouteille Bottle	FTP300033	30 ml	-	Boîte / Box	12/360
	FTP300133	30 ml	-	Boîte / Box	12/360
	FTP300233	30 ml	-	Boîte / Box	12/360



OUVRE-LETTRES

Letter openers

Lame poignard - Dagger shape blade

Manche plastique à virole - Plastic handle with ferrule

Avec protection de la lame - With blade's protection

REF.	DIM. (MM)	CARACTÉRISTIQUES SPECIFICATIONS	CONDITIONNEMENT PACKING	LV/PCB
FZZ100061	210	Acier inox-ABS Stainless steel-ABS	Vrac / Bulk	12/480
FZZ100162	210	Acier inox-ABS Stainless steel-ABS	LS / Pegboardable	10/240

JE SUIS UNE
FINE LAME !



GRATTOIR FORME SCALPEL

Scalpel erasing knife

Lame forme scalpel - Scalpel shape blade

Manche plastique - Plastic handle

REF.	DIM. (MM)	CARACTÉRISTIQUES SPECIFICATIONS	CONDITIONNEMENT PACKING	LV/PCB
FZZ100461	150	Acier inox-PP Stainless steel-PP	Vrac / Bulk	12/480
FZZ100562*	150	Acier inox-PP Stainless steel-PP	LS / Pegboardable	10/240

* Jusqu'à épuisement des stocks



GRATTOIR 2 USAGES

2 uses erasing knife

Lame 1/2 ronde - Half rounded blade

Manche plastique à virole - Plastic handle with ferrule

REF.	DIM. (MM)	CARACTÉRISTIQUES SPECIFICATIONS	CONDITIONNEMENT PACKING	LV/PCB
FZZ100261	176	Acier inox-PP Stainless steel-PP	Vrac / Bulk	12/480
FZZ100362*	176	Acier inox-PP Stainless steel-PP	LS / Pegboardable	10/240

* Jusqu'à épuisement des stocks



MOUILLEUR DE BUREAU

Sponge damper pad

Éponge synthétique avec un support plastique - Synthetic sponge with plastic support

REF.	DIM. (MM)	CARACTÉRISTIQUES SPECIFICATIONS	CONDITIONNEMENT PACKING	LV/PCB
FZZ200062	Ø 85	TPR	LS / Pegboardable	12/240



SACS NAVETTES COURRIER

Mail bags

REF. 900312 Avec un soufflet de 5 cm - With a 5 cm gusset

Pochette porte-étiquette - Label pouch

Fermeture éclair sécurisable - Zipper securable

Scellés de sécurité non fournis - Security seals not included

REF.	DIM. (HxLxP CM)	CARACTÉRISTIQUES SPECIFICATIONS	CONDITIONNEMENT PACKING	LV/PCB
900311	40 x 30	Nylon	Vrac / Bulk	1/96
900312	40 x 30 x 5	Nylon	Vrac / Bulk	1/96



COLLIERS DE SERRAGE PLASTIQUE

Sealing clamps

Lot de 1000 pièces - Lot of 1000 pieces

Longueur 9 cm, largeur 4 mm - Length 9 cm, width 4 mm

REF.	DIM. (MM)	CARACTÉRISTIQUES SPECIFICATIONS	CONDITIONNEMENT PACKING	LV/PCB
900313	90 x 4	Nylon	Vrac / Bulk	1/20

SERVICES GÉNÉRAUX

General services



PÈSE-COLIS Parcel scales

Waterproof IP 65 / Tare automatique - Waterproof IP 65 / Automatic tare weight
 Capacité 50 Kg, précision par : 5 g de 0 à 15 kg et 10 g de 15 kg à 50 kg -
 Capacity 50 Kg, accuracy 5 g from 0 to 15 kg and 10 g from 15 kg to 50 kg
 Plateau inox 300 x 230 mm - 300 x 230 mm stainless steel plate

REF.	DIM.	CARACTÉRISTIQUES SPECIFICATIONS	CONDITIONNEMENT PACKING	LIV/PCB
LBP50	-		Boîte / Box	1/4



PÈSE-COLIS Parcel scales

Grande capacité 200 kg, précision par 50 g - Large capacity 200 kg, accuracy every 50 g
 Ecran LCD 85 x 37 mm - 85 x 37 mm LCD display
 Plateau inox 388 x 308 mm - 388 x 308 mm stainless steel plate
 Câble et adaptateur fournis - Cable and adapter supplied
 Fonctionne avec 4 piles AA (incluses) - Operated with 4 AA batteries (included)

REF.	DIM.	CARACTÉRISTIQUES SPECIFICATIONS	CONDITIONNEMENT PACKING	LIV/PCB
PRO E-200	-	Inox Stainless steel	Boîte / Box	1/5



PÈSE-LETTRES Letter scales

Tare automatique - Automatic tare weight
 Capacité 5 kg, précision 1 g - Capacity 5 kg, accuracy 1 g
 Plateau en verre Ø 160 mm - Ø 160 mm glass plate
 Écran LCD 50 x 22 mm - 50 x 22 mm LCD display
 Fonctionne avec 3 piles AAA (incluses) - Operated with 3 AAA batteries (included)

REF.	DIM.	CARACTÉRISTIQUES SPECIFICATIONS	CONDITIONNEMENT PACKING	LIV/PCB
HBP900	-		Boîte / Box	1/6



MINI-BALANCE DE PRÉCISION Pocket precision scale

Capacité maximum 500 g x 0,01 g - Maximum capacity 500 g x 0.01 g
 Précision 0.019g - Accuracy 0.019g
 Fonctions tare, compteuse et auto off - Tare weight, counting and auto off functions
 Fonctionne avec 2 piles AAA 1.5 V (incluses) - Operated by 2 AAA - 1.5 V batteries (included)

REF.	DIM. (H X L X P) MM	CARACTÉRISTIQUES SPECIFICATIONS	CONDITIONNEMENT PACKING	LIV/PCB
4733	115x65x18	-	Boîte / Box	1/6

TRULY®



BALANCE ÉLECTRONIQUE ET CALCULATRICE E102 E102 Foldable digital electronic scale with calculator

Calculatrice : Affichage 12 chiffres - Solaire + piles (incluses) / Arrêt automatique - Piles incluses - Touches en silicone - Touches mémoire
 Calculator: 12 digits display - Solar + battery (included) / Automatic switch-off - Battery included - Plastic keys - Independent memory
Balance : Plateau en acier inoxydable - Piles (incluses) / Arrêt automatique - 6 unités de mesure : gn (grain) / oz (once) / ozt (troy ounce) / dwt (denier) / ct (carat) / g (gramme) - Capacité maximum de la balance : 1100g - 38,8oz - 35,365ozt - 16975,59gn - 707,316dwt - Précision : 0,1g
 Scale: Stainless steel pan - Battery (included) / Automatic switch-off - 6 different units : gn (grain) / oz (ounce) / ozt (troy ounce) / dwt (pennyweight) / ct (carat) / g (gram) - Maximum capacity of scale : 1100g - 38,8oz - 35,365ozt - 16975,59gn - 707,316dwt - Precision : 0,1g

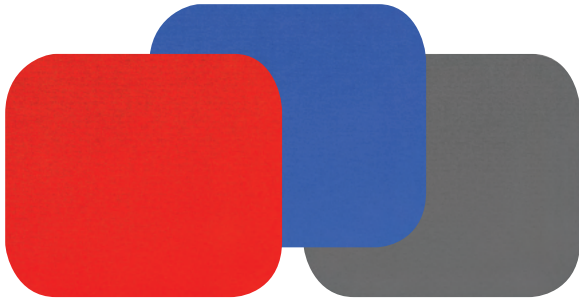

REF.	DIMENSIONS	CARACTÉRISTIQUES SPECIFICATIONS	CONDITIONNEMENT PACKING	LIV/PCB
E102	163 x 78 x 16 mm	12 chiffres 12 digits	Boîte / Box	1/25

ERGONOMIE AU BUREAU / OFFICE ERGONOMICS



TAPIS DE SOURIS Mouse pads

Tapis de souris souple en mousse - Soft foam mouse pads

REF.	DIM. (LxPMM)	CARACTÉRISTIQUES SPECIFICATIONS	CONDITIONNEMENT PACKING	LIV/PCB
GER300022	260 x 220 mm	EVA-Tissu EVA-Fabric 	LS / Pegboardable	50/400
GER300122	260 x 220 mm	EVA-Tissu EVA-Fabric 	LS / Pegboardable	50/400
GER300222	260 x 220 mm	EVA-Tissu EVA-Fabric 	LS / Pegboardable	50/400



TAPIS DE SOURIS ERGONOMIQUE Ergonomic mouse pads



Mousse Polyester et tissu - Polyester foam and fabric

REF.	DIM. (LxPMM)	CARACTÉRISTIQUES SPECIFICATIONS	CONDITIONNEMENT PACKING	LIV/PCB
GER310022	250 x 230 mm	Mousse polyester-Tissu Polyester foam-Fabric 	LS / Pegboardable	1/40



TAPIS DE SOURIS SOUS-MAIN DESSOUS LIÈGE Large mouse pad desk pad cork underside

Surface antidérapante en liège - Non-slip cork surface
Imitation cuir (PU) - Imitation leather (PU)

Suffisamment d'espace pour le clavier, la souris, l'ordinateur et le smartphone - Sufficient space for keyboard, mouse, computer and smartphone

REF.	DIM. (LxPMM)	CARACTÉRISTIQUES SPECIFICATIONS	CONDITIONNEMENT PACKING	LIV/PCB
GER330063	80 x 40 x 0,2 cm	PU / liège PU / cork 	Boîte / Box	1/20

SERVICES GÉNÉRAUX

General services



**GRAND TAPIS DE SOURIS SOUS-MAIN
AVEC CHARGEUR INDUCTION 15W**
Large mouse pad desk with induction charger 15w

Surface antidérapante en caoutchouc - Non-slip rubber surface
Imitation en cuir (PU) - Leather imitation (PU)
Câble USB 1 m - 1m USB cable
Suffisamment d'espace pour le clavier, la souris, l'ordinateur et le smartphone - Plenty of space for keyboard, mouse, computer and smartphone, and a lot of room to space

REF.	TAILLE SIZE	CARACTÉRISTIQUES SPECIFICATIONS	CONDITIONNEMENT PACKING	LIV/PCB
GER340163	80 x 40 cm	PU 	Boîte / Box	1/20



**GRAND TAPIS DE SOURIS SOUS-MAIN
AVEC CHARGEUR INDUCTION 15W**
Large mouse pad desk with induction charger 15w

Surface antidérapante en caoutchouc - Non-slip rubber surface
Câble USB 1 m - 1m USB cable
Suffisamment d'espace pour le clavier, la souris, l'ordinateur et le smartphone - Plenty of space for keyboard, mouse, computer and smartphone, and a lot of room to space

REF.	TAILLE SIZE	CARACTÉRISTIQUES SPECIFICATIONS	CONDITIONNEMENT PACKING	LIV/PCB
GER340063	80 x 40 cm	PU 	Boîte / Box	1/20



IMPRIMEZ INSTANTANÉMENT
N'IMPORTE OÙ, N'IMPORTE QUAND !

SERVICES GÉNÉRAUX

General services



MINI IMPRIMANTE À JET D'ENCRE PORTATIVE + UNE CARTOUCHE D'ENCRE NOIRE MINI PRINTER HANDHELD INKJET + INK CARTRIDGE BLACK

Coloris : noir - Colours: black

Hauteur d'impression : 12,7 mm - Print height: 12.7 mm

Distance d'impression : 1-5 mm - Print distance: 1-5 mm

Écran tactile : 8,89 cm - Touch-screen size: 8.89 cm

Résolution : 600 Dpi - Resolution: 600 dpi

26 langues disponibles - 26 languages available

Impression possible tous supports : mots, nombres, date, date d'expiration, date de production, logo, dessin, QR code, code-barres, etc - Printing possible on all media: words, numbers, date, expiry date, production date, logo, drawing, QR code, bar code, etc

Fourni avec une cartouche d'encre noire - Supplied with black ink cartridge

REF.	TAILLE SIZE	CARACTÉRISTIQUES SPECIFICATIONS	CONDITIONNEMENT PACKING	LIV/PCB
GIP000063	87 x 110 x 43 mm	/	 Boîte / Box	1/12

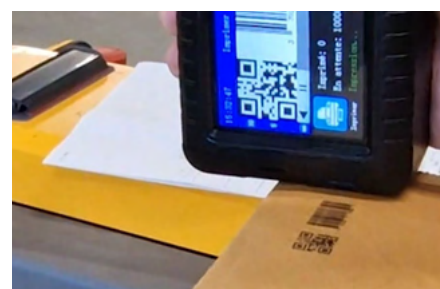
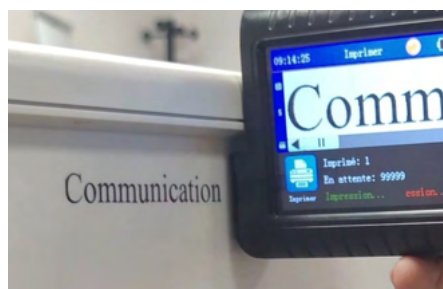

CARTOUCHE D'ENCRE NOIRE POUR MINI IMPRIMANTE À JET D'ENCRE PORTATIVE BLACK INK CARTRIDGE FOR MINI PRINTER HANDHELD INKJET

REF.	TAILLE SIZE	CARACTÉRISTIQUES SPECIFICATIONS	CONDITIONNEMENT PACKING	LIV/PCB
GIP900003	/	/	 Boîte / Box	1/12

SUPPORTS MONITEUR - PLASTIC MONITOR HOLDERS



Plateau rotatif 360° antidérapant - Non-slip 360° rotating plate
Pieds antidérapants - Slip-resistant feet



1 tiroir 320 x 290 x 30 mm - Single drawer 320 x 290 x 30 mm

REF.	DIM. (LXPHXMM)	CARACTÉRISTIQUES SPECIFICATIONS	CONDITIONNEMENT PACKING	UV/PCB
GER200263	400 x 300 x 60 Ø 200 (plateau/plate)	MDF-HIPS 	Boîte / Box	1/4

2 tiroirs 320 x 290 x 30 mm - Double drawer 320 x 290 x 30 mm

REF.	DIM. (LXPHXMM)	CARACTÉRISTIQUES SPECIFICATIONS	CONDITIONNEMENT PACKING	UV/PCB
GER200163	400 x 300 x 75 Ø 200 (plateau/plate)	MDF-HIPS 	Boîte / Box	1/4
GER200363	400 x 300 x 110 Ø 200 (plateau/plate)	MDF-HIPS 	Boîte / Box	1/4

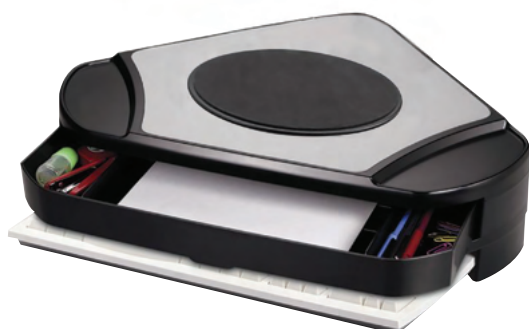

Support moniteur d'angle - Corner monitor holder
Plateau rotatif 360° antidérapant - Non-slip 360° rotating plate
Pieds antidérapants - Slip-resistant feet

Hauteur modulable 80 à 130 mm - Adjustable height 80 to 130 mm
1 tiroir 470 x 290 mm avec 2 plumiers - Single drawer 470 x 290 mm with 2 pencil boxes

REF.	DIM. (LXPHXMM)	CARACTÉRISTIQUES SPECIFICATIONS	CONDITIONNEMENT PACKING	UV/PCB
GER200063	530 x 310 x 80/130 Ø 250 (plateau/plate)	MDF-HIPS 	Boîte / Box	1/4

Support moniteur MDF - MDF monitor holder
Surface plane 300 x 200 mm - Flat surface 300 x 200 mm
Pieds antidérapants - Slip-resistant feet

REF.	DIM. (LXPHXMM)	CARACTÉRISTIQUES SPECIFICATIONS	CONDITIONNEMENT PACKING	UV/PCB
GER200463	300 x 200 x 110	MDF-HIPS 	Boîte / Box	1/6

SERVICES GÉNÉRAUX

General services

REPOSE-PIEDS - FOOTRESTS



Repose-pieds plastique inclinaison réglable (avant/arrière) - Adjustable plastic tilt footrest (front/back)

Surface bosselée antidérapante - Non-slip bumpy surface

Dimensions : 450 x 330 mm - Dimensions : 450 x 330 mm

Hauteur fixe 90 mm - Fixed height 90 mm

Base antidérapante - Non-slip base

REF.	DIM. (HXLXPMM)	CARACTÉRISTIQUES SPECIFICATIONS	CONDITIONNEMENT PACKING	UV/PCB
GER400063	450 x 330 x 90	PS 	Boîte / Box	1/5

Repose-pieds plastique hauteur/inclinaison (avant/arrière) réglables - Adjustable plastic height/tilt footrest (front/back)

Surface bosselée antidérapante - Non-slip bumpy surface

Dimensions : 450 x 330 mm - Dimensions : 450 x 330 mm

Hauteur modulable 100 à 170 mm - Adjustable height 100 to 170 mm

Pieds antidérapants - Non-slip feet

REF.	DIM. (HXLXPMM)	CARACTÉRISTIQUES SPECIFICATIONS	CONDITIONNEMENT PACKING	UV/PCB
GER400163	450 x 330 x 100/170	PS 	Boîte / Box	1/5

LE CONSEIL DE LA WONDAY FAMILY : ADOPTER CETTE POSTURE !

Wonday Family tip : adopt this posture !



MOBILIER D'ENTREPRISE / CORPORATE FURNITURE



CENDRIER/CORBELLE
Ashtray

Cendrier/corbelle acier inoxydable pour utilisation extérieure - Stainless steel wall-mounted ashtray for outdoor use
Capacité : 14 L - Capacity : 14 L

REF.	DIM. (HXLXPMM)	CARACTÉRISTIQUES SPECIFICATIONS	CONDITIONNEMENT PACKING	LIV/PCB
GEQ100073	Ø 200 x 650	Acier inoxydable Stainless steel	Boîte / Box	1/1



BOÎTES AUX LETTRES
Mailboxes

Boîte aux lettres métal usage intérieur/extérieur - Metal mail box for indoor/outdoor use

Ouverture/fermeture par serrure à clé (2 clés fournies) - Opening/closing by key lock (2 keys supplied)

Fenêtre d'introduction du courrier 235 x 30 mm avec volet aluminium - Letter slot 235 x 30 mm with aluminium flap

Conforme à la norme française NFD 27405 - In conformity with NFD 27405 French Post standard

GEQ900071 : Pied pour boîte aux lettres - Mail box support

REF.	DIM. (HXLXPMM)	CARACTÉRISTIQUES SPECIFICATIONS	CONDITIONNEMENT PACKING	LIV/PCB
GEQ000101	320 x 320 x 400	Métal Metal	Boîte / Box	1/1
GEQ000001	320 x 320 x 400	Métal Metal	Boîte / Box	1/1
GEQ900071	H 1100	Métal Metal	Vrac / Bulk	1/1



CENDRIERS MURAUX
Wall-mounted ashtrays

Cendrier mural pour utilisation extérieure - Wall-mounted ashtray for outdoor use
Ouverture/fermeture par serrure à clé (2 clés fournies) - Opening/closing by key lock (2 keys supplied)

Fixation mur (visserie fournie) - Wall mounting (hardware supplied)

GEQ100173 : capacité : 1,6 L - Capacity : 1,6 L

GEQ100273 : capacité : 2 L + casquette anti-pluie - Capacity : 2 L + rain cap

REF.	DIM. (HXLXPMM)	CARACTÉRISTIQUES SPECIFICATIONS	CONDITIONNEMENT PACKING	LIV/PCB
GEQ100173	Ø 76 x 500	Acier inoxydable Stainless steel	Boîte / Box	1/1
GEQ100273	373 x 280 x 140	Acier galvanisé Galvanized steel	Boîte / Box	1/1

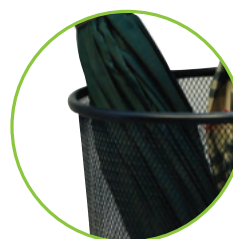

PORTE-PARAPLUIE ROND
Umbrella holder round

Métal perforé - Punched sheet metal

REF.	DIM. (HXLXPMM)	CARACTÉRISTIQUES SPECIFICATIONS	CONDITIONNEMENT PACKING	LIV/PCB
GEQ200071	Ø 264 x 490	Métal Metal	Vrac / Bulk	1/1

SERVICES GÉNÉRAUX

General services



**ÇA COULE
DE SOURCE !**

FONTAINE À EAU Water fountain

Eau chaude, eau froide, eau tempérée - Hot water, cold water, temperate water
Réfrigérateur 20L avec 1 étagère (<12°C) - Fridge 20L with 1 shelf (<12°C)
Bonbonne non incluse - Water carboy not included

REF.	DIM. (HxLxPMM)	CARACTÉRISTIQUES SPECIFICATIONS	CONDITIONNEMENT PACKING	LIV/PCB
GBU1200063	940 x 310 x 345	-	 Boîte / Box	1/1



BONBONNE D'EAU Water carboy



Bonbonne 18.9 L matière PET - PET material water carboy 5 gallons
Eau de source française goût neutre - French spring water neutral taste

REF.	DIM. (HxLxPMM)	CARACTÉRISTIQUES SPECIFICATIONS	CONDITIONNEMENT PACKING	LIV/PCB
GBU100033	-	PET   	Boîte / Box	1/36



DIABLE À BONBONNES Water carboys hand trolley



Diable structure aluminium - Aluminium hand trolley
2 roues gonflables pneumatiques sur jantes métal - 2 air-wheels rubber tyres on metal rims

Charge utile maximum : 250 kg - Loading capacity up to 250 kg
1 bavette aluminium fixe - 1 fixed aluminum platform

6 bavettes aluminium rabattables - 6 folding aluminum platforms

Poignées plastique anti écrasement - Anti-crushing plastic handles

Bonbonnes non incluses - Water carboy not included

REF.	DIM. (HxLxPMM)	CARACTÉRISTIQUES SPECIFICATIONS	CONDITIONNEMENT PACKING	LIV/PCB
3320	152,3 x 73 x 50,5 (ouvert) 152,3 x 59,9 x 50,5 (fermé)	Aluminium Aluminum	 Boîte / Box	1/1
MCH902761	Roue Wheel Ø 260 x 80	Caoutchouc/Métal Rubber-Metal	 Vrac / Bulk	1/1



CHANGEMENT D'HEURE ÉTÉ/HIVER AUTOMATIQUE

PENDULES MURALES À AIGUILLES Needles wall clocks

Boîtier ABS antichoc - Shockproof ABS frame

GHO010062 : Quartz - Fonctionne avec 1 pile AA/LR6-1,5V (incluse)
Operated by a AA/LR6-1,5V battery (included)

GHO010162 : Radio-contrôlée - Fonctionne avec 1 pile AA/LR6-1,5V (non incluse) - Radio-controlled (DCF) - Operated by a AA/LR6-1,5V battery (not included)

REF.	DIM. (CM)	CARACTÉRISTIQUES SPECIFICATIONS	CONDITIONNEMENT PACKING	LV/PCB
GHO010062	Ø 30	ABS	LS / Pegboardable	1/20
GHO010162	Ø 30	ABS	LS / Pegboardable	1/20

HYGIÈNE / HYGIENE



LAVETTES MICRO-FIBRES Microfibers towels

Lavable plus de 200 fois - Can be washed more than 200 times
280 gr/m² - 70% Polyester 30% Polyamide - 280 gr/m² - 70% Polyester 30% Polyamide
Lot de 5 lavettes - Set of 5 towels

REF.	DIM. (CM)	CARACTÉRISTIQUES SPECIFICATIONS	CONDITIONNEMENT PACKING	LV/PCB
N506132	40x40	-	LS / Pegboardable	1/10

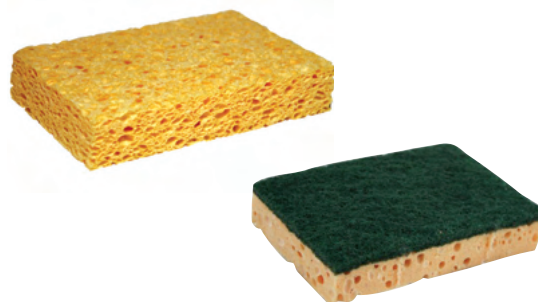

ÉPONGES VÉGÉTALES Vegetal sponges

N°6 135 x 90 x 24 mm
Éponge haute qualité - High quality sponge
Lot de 10 pièces - Set of 10 pieces

REF.	DIM. (CM)	CARACTÉRISTIQUES SPECIFICATIONS	CONDITIONNEMENT PACKING	LV/PCB
N508083	135x90x24	-	Vrac / Bulk	1/8
511168	127x89x22	Grattante Scratching	Vrac / Bulk	1/20



ÉPONGES MAGIQUES Magic sponges

S'utilise sans produit chimique - Used without chemical
Humidifier légèrement et frotter doucement - Slightly moisten and gently rub
Elimine facilement les traces de feutre, de caoutchouc, de semelles, de stylo ou de graisse, etc... - Easily eliminates smudges like felt-tip or ballpoint pen, rubber, shoe streaks, grease...

Lot de 3 éponges - Set of 3 sponges

REF.	DIM. (CM)	CARACTÉRISTIQUES SPECIFICATIONS	CONDITIONNEMENT PACKING	LV/PCB
511209	-	-	Vrac / Bulk	1/15

ÉQUIPEMENTS ÉLECTRIQUES / ELECTRICAL EQUIPMENT

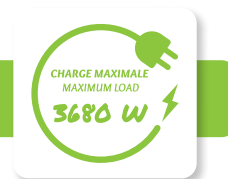

CORDONS PROLONGATEURS

Extension cords

Prise modèle FR 10/16A - 220V - FR model socket 10/16A - 220V

Câble 3 x 1.5 mm² - Cable 3 x 1.5 mm²

Avec protection enfants - With child protection



REF.	LONGUEUR (M) LENGTH (M)	CARACTÉRISTIQUES SPECIFICATIONS	CONDITIONNEMENT PACKING	LIV/PCB
GAE300062	3		LS / Pegboardable	1/40
GAE300162	5		LS / Pegboardable	1/20
GAE300262	10		LS / Pegboardable	1/10

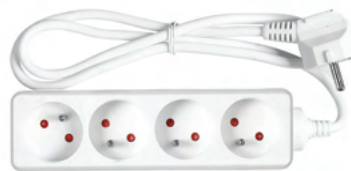

BLOCS 3 PRISES SANS INTERRUPTEUR

3-way sockets outlets without switch

Prise modèle FR 10/16A - 220V - FR model socket 10/16A - 220V

Câble 3 x 1.5 mm² - Cable 3 x 1.5 mm²

Avec protection enfants - With child protection

REF.	LONGUEUR (M) LENGTH (M)	CARACTÉRISTIQUES SPECIFICATIONS	CONDITIONNEMENT PACKING	LIV/PCB
GAE100162	1,5		LS / Pegboardable	1/50
GAE100262	4		LS / Pegboardable	1/20

BLOCS 4 PRISES SANS INTERRUPTEUR

4-way sockets outlets without switch

Prise modèle FR 10/16A - 220V - FR model socket 10/16A - 220V

Câble 3 x 1.5 mm² - Cable 3 x 1.5 mm²

Avec protection enfants - With child protection

REF.	LONGUEUR (M) LENGTH (M)	CARACTÉRISTIQUES SPECIFICATIONS	CONDITIONNEMENT PACKING	LIV/PCB
GAE000362	1,5		LS / Pegboardable	1/30
GAE000462	4		LS / Pegboardable	1 / 20



BLOCS 3 PRISES AVEC INTERRUPTEUR

3-way sockets outlets with switch

Prise modèle FR 10/16A - 220V - FR model socket 10/16A - 220V

Câble 3 x 1.5 mm² - Cable 3 x 1.5 mm²

Avec protection enfants - With child protection

REF.	LONGUEUR (M) LENGTH (M)	CARACTÉRISTIQUES SPECIFICATIONS	CONDITIONNEMENT PACKING	LIV/PCB
GAE000062	1,5		LS / Pegboardable	1/50
GAE000162	4		LS / Pegboardable	1/30

BLOCS 5 PRISES AVEC INTERRUPTEUR

5-way sockets outlets with switch

Prise modèle FR 10/16A - 220V - FR model socket 10/16A - 220V

Câble 3 x 1.5 mm² - Cable 3 x 1.5 mm²

Avec protection enfants - With child protection

REF.	LONGUEUR (M) LENGTH (M)	CARACTÉRISTIQUES SPECIFICATIONS	CONDITIONNEMENT PACKING	LIV/PCB
GAE100362	1,5		LS / Pegboardable	1/50
GAE100462	4		LS / Pegboardable	1/30



BLOCS 3 PRISES AVEC INTERRUPTEUR + PORTS USB 3-way sockets outlets with switch + USB ports

3 prises 16A - 230V - 3 sockets 16A - 230V
2 ports USB : 1 USB A & 1 USB C - 1 USB A & 1 USB C
Câble 3 x 1.5 mm² - Cable 3 x 1.5 mm²
Avec protection enfants - With child protection

REF.	LONGUEUR (M) LENGTH (M)	CARACTÉRISTIQUES SPECIFICATIONS	CONDITIONNEMENT PACKING	UV/PCB
GAE000662	1,5		LS / Pegboardable	1/24



BLOCS 4 PRISES AVEC INTERRUPTEUR + PORTS USB 4-way sockets outlets with switch + USB ports

4 prises 16A - 230V - 4 sockets 16A - 230V
2 ports USB : 1 USB A & 1 USB C - 1 USB A & 1 USB C
Câble 3 x 1.5 mm² - Cable 3 x 1.5 mm²
Avec protection enfants - With child protection

REF.	LONGUEUR (M) LENGTH (M)	CARACTÉRISTIQUES SPECIFICATIONS	CONDITIONNEMENT PACKING	UV/PCB
GAE000562	1,5		LS / Pegboardable	1/24



ENROULEURS 4 PRISES Cable reels 4 sockets

Enrouleurs mobiles manuels - Hand-operated portable cable reels
4 prises terre modèle FR 16A - 230V - 4 FR model sockets 16A - 230V with earthing
Câble 3 x 1.5 mm² - Cable 3 x 1,5 mm²
Avec disjoncteur thermique - With thermal protection switch
Avec protection enfants - With child protection
Charge maximale : câble enroulé : 1100W 230V câble déroulé : 3200W 230V
- Maximum load : coiled cable : 1100W 230V uncoiled cable : 3200W 230V
Poignée de transport - Carry handle

REF.	LONGUEUR (M) LENGTH (M)	CARACTÉRISTIQUES SPECIFICATIONS	CONDITIONNEMENT PACKING	UV/PCB
GAE500061	10		Boîte / Box	1/10
GAE500161	25		Boîte / Box	1/4

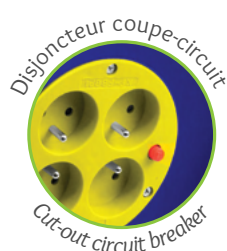

TRIPLETE Triplite

2 prises 16A + 1 prise 6A - 2 sockets 16A + 1 socket 6A
Modèle FR - FR model
Avec protection enfants - With child protection

REF.	LONGUEUR (M) LENGTH (M)	CARACTÉRISTIQUES SPECIFICATIONS	CONDITIONNEMENT PACKING	UV/PCB
GAE400062	-		LS / Pegboardable	1/100



PROTÈGE-CÂBLES À CLIP Pass electrical cables

Sécurise le passage des câbles électriques - Prevent accidents & safely pass electrical cables
Découpe à la longueur souhaitée - Cutting dimensions as required
Double filière 12 x 12 mm - Double channel 12 x 12 mm

REF.	DIM. (HXLXPM)	CARACTÉRISTIQUES SPECIFICATIONS	CONDITIONNEMENT PACKING	UV/PCB
GAE900163	3	PVC souple	Boîte / Box	1/60
GAE900263	5	PVC souple	Boîte / Box	1/60



Distribution France (DOM-TOM inclus) uniquement.
Retail France (including DOM-TOM) only.

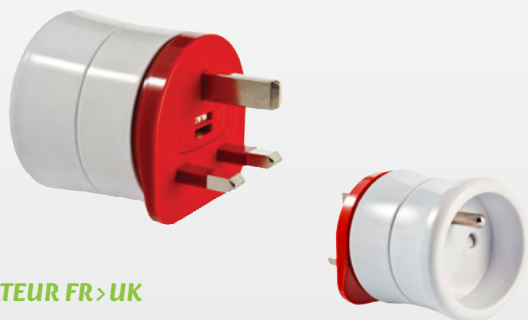

ADAPTATEUR FR > UK

Adaptateur France > Royaume-Uni + 56 pays
250 VAC 13A

REF.	DIM. (HXLXPMM)	CARACTÉRISTIQUES SPECIFICATIONS	CONDITIONNEMENT PACKING	UV/PCB
ADF-7B*	70 x 50 x 50		LS / Pegboardable	1/5

* Jusqu'à épuisement des stocks

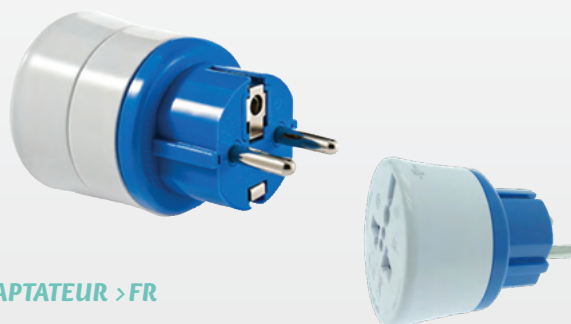

ADAPTATEUR > FR

Adaptateur tous pays > France
250 VAC 16A

REF.	DIM. (HXLXPMM)	CARACTÉRISTIQUES SPECIFICATIONS	CONDITIONNEMENT PACKING	UV/PCB
ADU-9B	88 x 55 x 55		LS / Pegboardable	1/5

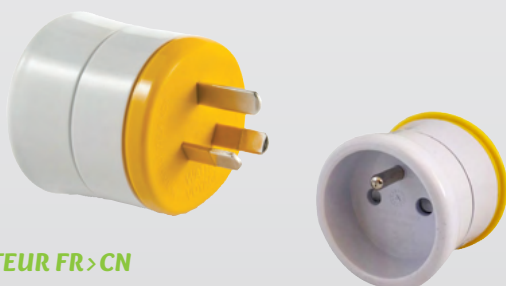

ADAPTATEUR FR > CN

Adaptateur France > Chine, Australie + 15 pays
250 VAC 10A

REF.	DIM. (HXLXPMM)	CARACTÉRISTIQUES SPECIFICATIONS	CONDITIONNEMENT PACKING	UV/PCB
ADF-16B*	70 x 50 x 50		LS / Pegboardable	1/5

* Jusqu'à épuisement des stocks



BIPLITE

Multiprise 2 ports 16A à tête rotative à 180°

REF.	DIM. (HXLXPMM)	CARACTÉRISTIQUES SPECIFICATIONS	CONDITIONNEMENT PACKING	UV/PCB
MPF2C-RO-CT*	44 x 72 x 85		LS / Pegboardable	1/4

* Jusqu'à épuisement des stocks



TRIPLITE

Multiprise 3 ports 16A à tête rotative à 180°



REF.	DIM. (HXLXPMM)	CARACTÉRISTIQUES SPECIFICATIONS	CONDITIONNEMENT PACKING	UV/PCB
MPF3C-BL-CT	60 x 82 x 93		LS / Pegboardable	1/4
MPF3C-GR-CT	60 x 82 x 93		LS / Pegboardable	1/4
MPF3C-BLC-CT	60 x 82 x 93		LS / Pegboardable	1/4
MPF3C-TU-CT*	60 x 82 x 93		LS / Pegboardable	1/4

* Jusqu'à épuisement des stocks



TWISTER



Multiprise ronde de 6 ports 16A avec protection parafoudre
 Interrupteur de mise sous tension
 Rallonge 1.70 m

REF.	DIM. (HXLXPMM)	CARACTÉRISTIQUES SPECIFICATIONS	CONDITIONNEMENT PACKING	UV/PCB
MP-TWISTER	96 x 86 x 100	 	LS / Pegboardable	1/4



CRISTAL



Multiprise 6 prises 16A avec protection parafoudre
 Interrupteur de mise sous tension
 Rallonge 1.70 m

REF.	DIM. (HXLXPMM)	CARACTÉRISTIQUES SPECIFICATIONS	CONDITIONNEMENT PACKING	UV/PCB
MPF6-B	63 x 370 x 37	 	LS / Pegboardable	1/4



DUETWO

Multiprise déportée 2 ports 16A
 Rallonge 1 m
 1 prise avec 3 ventouses de fixation



REF.	DIM. (HXLXPMM)	CARACTÉRISTIQUES SPECIFICATIONS	CONDITIONNEMENT PACKING	UV/PCB
MP-DUETWO-GR-B*	85 x 75 x 75	 	LS / Pegboardable	1/4

* Jusqu'à épuisement des stocks



WATTBALL

Multiprise ronde avec 1 prise 6A, 2 prises 16A &
 2 ports USB 2.1A
 Interrupteur de mise sous tension
 Câble 1,50 m

REF.	DIM. (HXLXPMM)	CARACTÉRISTIQUES SPECIFICATIONS	CONDITIONNEMENT PACKING	UV/PCB
MPWATTBALL-BL-CT	96 x 86 x 100	 	LS / Pegboardable	1/4
MPWATTBALL-GR-CT	96 x 86 x 100	 	LS / Pegboardable	1/4



BRICOLER - JARDINER

Tinker - Garden

CUTTERS 9 MM / CUTTERS 9 MM

BI-MATIÈRE

Bi-material

Corps bi-matière ABS/TPR - Bi-material ABS/TPR body

Guide lame métal - Metal frame

Système autobloquant - Auto-lock system

Embout casse-lame - Snap-off blade system

REF.	TAILLE (MM) SIZE (MM)	CARACTÉRISTIQUES SPECIFICATIONS	CONDITIONNEMENT PACKING	UV/PCB
BCU090681	9	ABS-TPR-Métal ABS-TPR- Metal	Vrac / Bulk	12/240



MÉTAL

Metal

Corps alliage zinc - Zinc alloy body

Guide lame métal - Metal frame

Système autobloquant ABS - ABS auto-lock system

Embout casse-lame - Snap-off blade system

REF.	TAILLE (MM) SIZE (MM)	CARACTÉRISTIQUES SPECIFICATIONS	CONDITIONNEMENT PACKING	UV/PCB
BCU090471	9	Zinc	Vrac / Bulk	25/200
BCU090572*	9	Zinc	LS / Pegboardable	10/240



* Jusqu'à épaisseur des stocks

Corps métal laqué - Metal lacquered body

Système autobloquant - Auto-lock system

Embout casse-lame - Snap-off blade system

REF.	TAILLE (MM) SIZE (MM)	CARACTÉRISTIQUES SPECIFICATIONS	CONDITIONNEMENT PACKING	UV/PCB
BCU090372	9	Métal Metal	LS / Pegboardable	10/240



BI-MATIÈRE

Bi-material

Corps bi-matière ABS/TPR - Bi-material ABS/TPR body

Glissière métal - Metal slide

Système autobloquant - Self-locking system

Chargeur 3 lames - 3 blades reloader

Bouton de libération cartouche - Cartridge release button

Rechargement automatique de lame - Automatic blade reloading



REF.	TAILLE (MM) SIZE (MM)	CARACTÉRISTIQUES SPECIFICATIONS	CONDITIONNEMENT PACKING	UV/PCB
BCU090282	9	ABS-TPR-Métal ABS-TPR- Metal	LS / Pegboardable	12/240

PLASTIQUE

Plastic

Corps plastique/ABS - Plastic/ABS body

Guide lame métal - Metal frame

Système autobloquant - Self-locking system

Embout casse-lame - Snap-off blade system



REF.	TAILLE (MM) SIZE (MM)	CARACTÉRISTIQUES SPECIFICATIONS	CONDITIONNEMENT PACKING	UV/PCB
BCU090862	9	ABS-Métal ABS-Metal	LS / Pegboardable	10/240

Corps plastique/ABS revêtement soft - Plastic/ABS body soft touch

Guide lame métal - Metal frame

Système autobloquant - Self-locking system

Embout casse-lame - Snap-off blade system



REF.	TAILLE (MM) SIZE (MM)	CARACTÉRISTIQUES SPECIFICATIONS	CONDITIONNEMENT PACKING	UV/PCB
BCU090782	9	ABS-Métal ABS-Metal	LS / Pegboardable	12/288

Corps plastique/ABS - Plastic/ABS body

Blocage lame manuel - Manual lock system

Embout casse-lame - Snap-off blade system

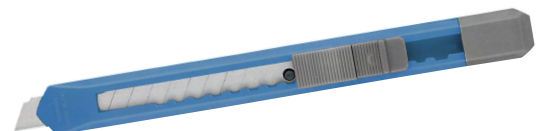

REF.	TAILLE (MM) SIZE (MM)	CARACTÉRISTIQUES SPECIFICATIONS	CONDITIONNEMENT PACKING	UV/PCB
BCU090062	9	ABS ABS	LS / Pegboardable	24/768

MODÈLE MODEL	REF.	TAILLE (MM) SIZE (MM)	CARACTÉRISTIQUES SPECIFICATIONS	CONDITIONNEMENT PACKING	UV/PCB
LAMES PRÉDÉCOUPÉES 12 SEGMENTS PRECUT BLADES 12 SEGMENTS	BLC090072	9 mm x 10 pcs	Acier carbone 60HRC Carbon steel 60 HRC	LS / Pegboardable	25/200
	BLC090171	9 mm x 10 pcs	Acier carbone 60HRC Carbon steel 60 HRC	Étui / Tube	10/400

BRICOLER - JARDINER

Tinker - Garden

CUTTERS 18 MM / CUTTERS 18 MM

BI-MATIÈRE

Bi-material

Corps bi-matière ABS/TPR - Bi-material ABS/TPR body

Guide lame métal - Metal frame

Système autobloquant - Auto-lock system

Embout casse-lame - Snap-off blade system

Fourni avec 2 lames - 2 blades supplied

REF.	TAILLE (MM) SIZE (MM)	CARACTÉRISTIQUES SPECIFICATIONS	CONDITIONNEMENT PACKING	UV/PCB
BCU181082	18	ABS-TPR-Métal ABS-TPR- Metal	 LS / Pegboardable	12/96



Corps bi-matière ABS/TPR - Bi-material ABS/TPR body

Guide lame métal - Metal frame

Système autobloquant - Auto-lock system

Embout casse-lame - Snap-off blade system

REF.	TAILLE (MM) SIZE (MM)	CARACTÉRISTIQUES SPECIFICATIONS	CONDITIONNEMENT PACKING	UV/PCB
BCU180981	18	ABS-TPR-Métal ABS-TPR- Metal	 Vrac / Bulk	12/144



PROFESSIONNEL

Professional

Cutter professionnel ergonomique - Ergonomic professional cutter

Corps bi-matière ABS/TPR - Bi-material ABS/rubber-grip body

Guide lame métal - Metal frame

Système autobloquant - Auto-lock system

Embout casse-lame - Snap-off blade system

Bouton de libération cartouche - Cartridge release button

Chargeur automatique 6 lames - 6 blades auto-load refill

REF.	TAILLE (MM) SIZE (MM)	CARACTÉRISTIQUES SPECIFICATIONS	CONDITIONNEMENT PACKING	UV/PCB
BCU180282	18	ABS-TPR-Métal ABS-TPR- Metal	 LS / Pegboardable	12/48
BLC180071	18	Acier carbone 58±2 HRC Carbon steel 58±2 HRC	Cassette de 6 lames 6-blade cartridge	Vrac / Bulk 24/240



Cutter professionnel 2 en 1 - 2 in 1 professional cutter

Corps bi-matière ABS/TPR - Bi-material ABS/TPR body

Guide lame métal - Metal frame

2 positions de lame : autobloquant ou auto rétractable - Dual system : self-retracting or self-lock blade

Embout casse-lame - Snap-off blade system

Fourni avec 2 lames 7 segments 5 mm - 2 blades 2 blades 7 segments 5 mm supplied

REF.	TAILLE (MM) SIZE (MM)	CARACTÉRISTIQUES SPECIFICATIONS	CONDITIONNEMENT PACKING	UV/PCB
BCU180382	18	ABS-TPR-Métal ABS-TPR- Metal	 LS / Pegboardable	10/120
BLC180372	18	Acier carbone 60 HRC Carbon steel 60 HRC	10 lames de rechange 10 spare blades	LS / Pegboardable 10/200





MÉTAL Metal

Corps alliage zinc - Zinc alloy body

Guide lame métal - Metal frame

Système autobloquant ABS - ABS auto-lock system

Embout casse-lame - Snap-off blade system

REF.	TAILLE (MM) SIZE (MM)	CARACTÉRISTIQUES SPECIFICATIONS	CONDITIONNEMENT PACKING	LIV/PCB
BCU181171	18	Zinc 	Vrac / Bulk	10/100
BCU181272*	18	Zinc 	LS / Pegboardable	10/120

* Jusqu'à épaisseur des stocks





PLASTIQUE Plastic

Corps plastique/ABS - Plastic/ABS body

Guide lame métal - Metal frame

Système autobloquant - Auto-lock system

Embout casse-lame - Snap-off blade system

REF.	TAILLE (MM) SIZE (MM)	CARACTÉRISTIQUES SPECIFICATIONS	CONDITIONNEMENT PACKING	LIV/PCB
BCU180661	18	ABS-Métal ABS-Metal 	Vrac / Bulk	24/192
BCU180762	18	ABS-Métal ABS-Metal 	LS / Pegboardable	10/240



Corps plastique/ABS revêtement aspect soft - Plastic/ABS body soft aspect touch

Guide lame métal - Metal frame

Blocage lame manuel - Manual lock system

Embout casse-lame - Snap-off blade system

REF.	TAILLE (MM) SIZE (MM)	CARACTÉRISTIQUES SPECIFICATIONS	CONDITIONNEMENT PACKING	LIV/PCB
BCU181382	18	ABS-Métal ABS-Metal 	LS / Pegboardable	12/144

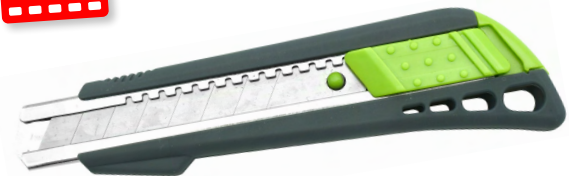

Corps bi-matière ABS/TPR - Bi-material ABS/TPR body

Guide lame métal - Metal frame



Blocage à molette - Twist lock system

+ 2 lames de rechange dans le manche

+ 2 spare blades inside the cutter

REF.	TAILLE (MM) SIZE (MM)	CARACTÉRISTIQUES SPECIFICATIONS	CONDITIONNEMENT PACKING	LIV/PCB
BCU180182	18	ABS-TPR-Métal ABS-TPR-Metal 	LS / Pegboardable	12/192



MODÈLE MODEL	REF.	TAILLE (MM) SIZE (MM)	CARACTÉRISTIQUES SPECIFICATIONS	CONDITIONNEMENT PACKING	LIV/PCB
LAMES PRÉDÉCOUPÉES 7 SEGMENTS PRECUT BLADES 7 SEGMENTS	BLC180171	18 mm x 10 pcs	Acier carbone 60HRC Carbon steel 60 HRC 	Étui / Tube	10/200
	BLC180272	18 mm x 10 pcs	Acier carbone 60HRC Carbon steel 60 HRC 	LS / Pegboardable	25/200

BRICOLER - JARDINER

Tinker - Garden

PLASTIQUE

Plastic

Corps plastique/ABS - Plastic/ABS body

Guide lame métal - Metal frame

Blocage lame manuel - Manual lock system

Embout casse-lame - Snap-off blade system

REF.	TAILLE (MM) SIZE (MM)	CARACTÉRISTIQUES SPECIFICATIONS	CONDITIONNEMENT PACKING	UV/PCB
BCU180861	18	ABS-Métal ABS-Metal 	Vrac / Bulk	12/240



Cutter professionnel - Professional cutter

Corps plastique/ABS - Plastic/ABS body

Blocage lame manuel - Manual lock system

Embout casse-lame - Snap-off blade system

Recharge automatique 6 lames - 6 blades auto-load refill



REF.	TAILLE (MM) SIZE (MM)	CARACTÉRISTIQUES SPECIFICATIONS	CONDITIONNEMENT PACKING	UV/PCB	
BCU180562	18	ABS ABS 	LS / Pegboardable	12/96	
BLC180472	18 mm x 6 pcs	Acier carbone SK2 Carbon steel SK2	Cassette de 6 lames 6-blades cartridge	LS / Pegboardable	12/144



Corps plastique/ABS - Plastic/ABS body

Blocage lame manuel - Manual lock system

Embout casse-lame - Snap-off blade system

REF.	TAILLE (MM) SIZE (MM)	CARACTÉRISTIQUES SPECIFICATIONS	CONDITIONNEMENT PACKING	UV/PCB
BCU180462	18	ABS ABS  	LS / Pegboardable	10/180





Corps plastique/ABS - Plastic/ABS body

Blocage lame manuel - Manual lock system

Embout casse-lame - Snap-off blade system

REF.	TAILLE (MM) SIZE (MM)	CARACTÉRISTIQUES SPECIFICATIONS	CONDITIONNEMENT PACKING	UV/PCB
BCU180062	18	ABS ABS  	LS / Pegboardable	12/288



MODÈLE MODEL	REF.	TAILLE (MM) SIZE (MM)	CARACTÉRISTIQUES SPECIFICATIONS	CONDITIONNEMENT PACKING	UV/PCB
LAMES PRÉDÉCOUPÉES 7 SEGMENTS PRE-CUT BLADES 7 SEGMENTS	BLC180171	18 mm x 10 pcs	Acier carbone 60HRC Carbon steel 60 HRC 	Étui / Tube	10/200
	BLC180272	18 mm x 10 pcs	Acier carbone 60HRC Carbon steel 60 HRC 	LS / Pegboardable	25/200

CUTTERS TRAPÈZES / TRAPEZOÏDAL CUTTERS

PROFESSIONNEL

Professional

Cutter professionnel haute sécurité - High safety professional cutter
 Corps bi-matière alliage zinc/TPR - Bi-material zinc alloy/soft touch TPR body
 Système auto-rétractable double sécurité de la lame - Dual safety self-retracting blade system
 Mécanisme de changement rapide des lames - Quick change blade mechanism

REF.	TAILLE (MM) SIZE (MM)	CARACTÉRISTIQUES SPECIFICATIONS	CONDITIONNEMENT PACKING	UV/PCB
BCU300382	-	TPR-Zinc 	LS Pegboardable	12/48



MÉTAL

Metal

Cutter de sécurité - Safety cutter
 Corps bi-matière alliage aluminium/TPR - Bi-material TPR/aluminum alloy body
 Lame trapèze 60 mm - Trapezoïdal blade 60 mm
 Système auto-rétractable - Self-retracting system

REF.	TAILLE (MM) SIZE (MM)	CARACTÉRISTIQUES SPECIFICATIONS	CONDITIONNEMENT PACKING	UV/PCB
BCU300281	-	TPR-Aluminium TPR-Aluminum 	Vrac Bulk	12/96
BCU300082	-	TPR-Aluminium TPR-Aluminum 	LS Pegboardable	10/120







ÉCO

Eco

Corps ABS - ABS body
 Système auto-rétractable de la lame - Self-retracting blade system

REF.	TAILLE (MM) SIZE (MM)	CARACTÉRISTIQUES SPECIFICATIONS	CONDITIONNEMENT PACKING	UV/PCB
BCU300161	-	ABS ABS 	Vrac Bulk	24/480



MODÈLE MODEL	REF.	TAILLE (MM) SIZE (MM)	CARACTÉRISTIQUES SPECIFICATIONS	CONDITIONNEMENT PACKING	UV/PCB
LAMES TRAPÈZES TRAPEZOÏDAL BLADES	BLC300271	61 x 19 Étui / Tube x 5 pcs	Acier carbone 60 HRC Carbon steel 60 HRC 	Étui / Tube	12/240
	BLC300072	61 x 19 Étui / Tube x 10 pcs	Acier carbone 60 HRC Carbon steel 60 HRC 	LS Pegboardable	10/240
	BLC300472	61 x 19 Distributeur / Dispenser x 5 pcs	Acier carbone 60 HRC Carbon steel 60 HRC 	Étui / Tube	20/100
	BLC300372*	3 cassettes x5 lames 3 cartridge x5 blades	Acier carbone 60 HRC Carbon steel 60 HRC 	LS Pegboardable	6/72

* Jusqu'à épuisement des stocks

BRICOLER - JARDINER

Tinker - Garden



MINI CUTTER CÉRAMIQUE

Ceramic mini cutter

Lame céramique bout arrondi - Ceramic blade rounded edge

Corps ABS - ABS body

Système auto-rétractable de la lame - Self-retracting blade system

Courseur de verrouillage - Locking cursor

REF.	TAILLE (MM) SIZE (MM)	CARACTÉRISTIQUES SPECIFICATIONS	CONDITIONNEMENT PACKING	LIV/PCB
B 4172.01*	94,5 x 27	ABS	 LS / Pegboardable	12/240

* Jusqu'à épuisement des stocks



FERRET

Ouvre-carton polycarbonate de haute sécurité « Ferret » - High security polycarbonate carton opener «Ferret»

Ambidextre - Ambidextrous

Lame trapèze bout arrondi rétractable avec renfort métallique - Retractable rounded edge trapezoidal blade with metallic reinforcement

Gâchette «va et vient» verrouillable - 2 ways trigger with safety lock

3 profondeurs de coupe - 3 possible cutting depths

Fourni avec 1 lame 54 mm - 1 blade 54 mm supplied

REF.	TAILLE (MM) SIZE (MM)	CARACTÉRISTIQUES SPECIFICATIONS	CONDITIONNEMENT PACKING	LIV/PCB
67.1.152*	240	PC 	LS / Pegboardable	10/100
153.6	60	Acier supérieur 64 HRC High steel 64 HRC Lames trapèze droite Straight trapezoidal blades	Étui / Tube	10/200

* Jusqu'à épuisement des stocks

CHARTRON

Ouvre-carton polycarbonate de sécurité « Chartron » - Security polycarbonate carton opener «Chartron»

Ambidextre - Ambidextrous

Lame trapèze bout arrondi rétractable - Retractable rounded edge trapezoidal blade

Gâchette «va et vient» verrouillable - 2 ways trigger with safety lock

3 profondeurs de coupe - 3 possible cutting depths

Fourni avec 1 lame 54 mm - 1 blade 54 mm supplied

REF.	TAILLE (MM) SIZE (MM)	CARACTÉRISTIQUES SPECIFICATIONS	CONDITIONNEMENT PACKING	LIV/PCB
160.1.152 A	240	PC 	LS / Pegboardable	10/100
153.6	60	Acier supérieur 64 HRC High steel 64 HRC Lames trapèze droite Straight trapezoidal blades	Étui / Tube	10/200



OUVRE-CARTON SÉCURITÉ

Safety box cutter

Lame céramique bout arrondi - Ceramic blade rounded edge

Corps nylon/TPR - Nylon/TPR body

Poignée ergonomique en forme de «J» - Ergonomic «J» shaped handle

Système auto-rétractable de la lame - Self-retracting blade system

Changement facile de la lame - Easy blade change

Ambidextre - Ambidextrous

REF.	TAILLE (MM) SIZE (MM)	CARACTÉRISTIQUES SPECIFICATIONS	CONDITIONNEMENT PACKING	LIV/PCB
10503*	177	Nylon-TPR 	LS / Pegboardable	6/24
10404*	33 x 6,5	Céramique (Oxyde de zirconium) Ceramic (zirconium oxid) 4 lames 4 blades	LS / Pegboardable	6/48

* Jusqu'à épuisement des stocks

STYLOS CUTTERS

Pen cutters

Lame céramique bout arrondi - Ceramic blade rounded edge

Corps nylon/TPR - Nylon/TPR body

Blocage manuel 3 positions - Manual locking 3 positions

Système auto-rétractable de la lame - Self-retracting blade system

Changement facile de la lame - Easy blade change

REF.	TAILLE (MM) SIZE (MM)	CARACTÉRISTIQUES SPECIFICATIONS	CONDITIONNEMENT PACKING	LIV/PCB
10513*	175	Nylon-TPR 	LS / Pegboardable	12/192
10404*	33 x 6,5	Céramique (Oxyde de zirconium) Ceramic (zirconium oxid) 4 lames 4 blades	LS / Pegboardable	6/48

* Jusqu'à épuisement des stocks

GRATTOIRS / SCRAPERS



GRATTOIR TÉLESCOPIQUE

Extendable scraper

Grattoir avec manche télescopique 75 à 150 cm - Scraper with 75 to 150 cm extendable handle

Longueur de lame 148 mm - Blade length 148 mm

Poignée TPR - TPR handle

Lame acier carbone SK2 interchangeable - Interchangeable carbon steel SK2 blade

REF.	TAILLE (CM) SIZE (CM)	CARACTÉRISTIQUES SPECIFICATIONS	CONDITIONNEMENT PACKING	UV/PCB
BCU550082*	75 à 150	Alliage aluminium / TPR Aluminum alloy / TPR		LS / Pegboardable 1/10

* Jusqu'à épuisement des stocks

GRATTOIR MANCHE LONG

Long handle scraper

Longueur de lame 100 mm - Blade length 100 mm

Poignée TPR - TPR handle

Lame 100 mm interchangeable - 100mm interchangeable blade

Blocage à molette - Twist lock system

REF.	TAILLE (CM) SIZE (CM)	CARACTÉRISTIQUES SPECIFICATIONS	CONDITIONNEMENT PACKING	UV/PCB
BCU550182	-	Métal / TPR Metal / TPR		Vrac / Bulk 12/72
BLC550071*	10	Acier carbone 60 HRC Carbon steel 60 HRC	10 lames de rechange 10 spare blades	Vrac / Bulk 1/250

* Jusqu'à épuisement des stocks



GRATTOIR MULTIFONCTION

Multipurpose scraper

Grattoir multifonction bi-matière pliable - Foldable bi-material multipurpose scraper

Lame acier inoxydable - Stainless steel blade

Poignée alliage zinc/TPR - Zinc alloy/TPR handle

Prise en main ergonomique - Ergonomic grip handle

REF.	TAILLE (CM) SIZE (CM)	CARACTÉRISTIQUES SPECIFICATIONS	CONDITIONNEMENT PACKING	UV/PCB
BCU550382*	-	Zinc / TPR		Vrac / Bulk 6/36

* Jusqu'à épuisement des stocks



GRATTE-VITRE

Window scraper

Gratte-vitre ABS - ABS window scraper

Capuchon de protection - Protective cap

Lame 61 mm acier carbone 60 HRC remplaçable - 61 mm carbon steel 60 HRC replaceable blade

REF.	TAILLE (CM) SIZE (CM)	CARACTÉRISTIQUES SPECIFICATIONS	CONDITIONNEMENT PACKING	UV/PCB
SX53-1*	-	ABS		LS / Pegboardable 25/300
BLC300472	6,1 x 1,9	Acier carbone 60 HRC Carbon steel 60 HRC	Distributeur /Dispenser x 5 pcs	Étui / Tube 20/100

* Jusqu'à épuisement des stocks

BRICOLER - JARDINER

Tinker - Garden

OUTILLAGE À MAIN / HAND TOOLS



TOURNEVIS Screwdrivers

Lot de 7 tournevis isolés - Set of 7 pcs isolated screwdrivers
Malette de rangement - Storage case

- n°3x60mm - n°4,5x80mm - n°6x100mm
- n°0,4x2,5x75mm, n°0,8x2,5x100mm, n°1,0x5,5x125mm, n°1,2x6,5x150mm

REF.	TAILLE (MM) SIZE (MM)	CARACTÉRISTIQUES SPECIFICATIONS	CONDITIONNEMENT PACKING	UV/PCB
14.7171	-	PP-TPR 	LS / Pegboardable	1/20



CLÉS PLATES Combination wrenches

Lot 8 clés plates mixtes - Set of 8 combination wrenches
N°8-10-11-12-13-14-17-19 mm
Sous coffret pegboardable - Pegboardable storage case

REF.	TAILLE (MM) SIZE (MM)	CARACTÉRISTIQUES SPECIFICATIONS	CONDITIONNEMENT PACKING	UV/PCB
14.7170*	-	Acier Steel 	LS / Pegboardable	1/20



* Jusqu'à épuisement des stocks



CAISSES À OUTILS Tools boxes



14.7166 : Caisse à outils vide - Tools box without tools
14.7172 : Caisse à outils avec 10 outils - Tools box equipped with 10 tools
2 compartiments extérieurs - 2 outer compartments
1 casier interne amovible - 1 removable internal locker
1 pince universelle, 1 marteau - 1 universal plier, 1 clawhammer
1 clé à molette, 1 jeu de 7 tournevis - 1 adjustable wrench, 1 set of 7 pcs isolated screwdrivers

REF.	TAILLE (MM) SIZE (MM)	CARACTÉRISTIQUES SPECIFICATIONS	CONDITIONNEMENT PACKING	UV/PCB
14.7166	400 x 210 x 180	PP 	Vrac / Bulk	1/9
14.7172 +10 outils / +10 tools	400 x 210 x 180	PP 	Vrac / Bulk	1/1



CLÉ À MOLETTE Adjustable wrench

Clé à molette 20 cm - 20 cm adjustable wrench
Ouverture graduée - Graduated opening

REF.	TAILLE (MM) SIZE (MM)	CARACTÉRISTIQUES SPECIFICATIONS	CONDITIONNEMENT PACKING	UV/PCB
14.7168	200	Acier Steel 	Vrac / Bulk	6/48

AGRAFEUSE MURALE 4-8 MM STAPLER GUN 4-8 MM

Poignée chromée - Chrome plated handle
Corps métal laqué - Lacquered metal body
Livrée avec 200 agrafes - 200 staples included

REF.	TAILLE/ SIZE	CARACTÉRISTIQUES SPECIFICATIONS	CONDITIONNEMENT PACKING	UV/PCB
BAG100072	4-8 mm	Métal / Metal 	LS / Pegboardable	1/24



MARTEAU ARRACHE POINTES Claw hammer

Manche fibre de verre/TPR - Fiberglass/TPR handle

REF.	TAILLE (MM) SIZE (MM)	CARACTÉRISTIQUES SPECIFICATIONS	CONDITIONNEMENT PACKING	UV/PCB
14.7169	-	Fibre de verre-TPR-Acier Fiberglass-TPR-Steel	Vrac / Bulk	6/60



PINCE UNIVERSELLE Combination plier

Pince universelle 15 cm type européen - Universal plier 15 cm european type
Poignées PP/TPR - PP/TPR handles

REF.	TAILLE (MM) SIZE (MM)	CARACTÉRISTIQUES SPECIFICATIONS	CONDITIONNEMENT PACKING	UV/PCB
14.7167	150	PP-TPR-Acier PP-TPR-Steel	LS / Pegboardable	6/60



PINCE COUPANTE Cutting plier

Poignée bi-matière antidérapant (PP-TPR) - Non-slip bi-material handles (PP-TPR)
Ressort de rappel - Return spring

REF.	TAILLE (MM) SIZE (MM)	CARACTÉRISTIQUES SPECIFICATIONS	CONDITIONNEMENT PACKING	UV/PCB
BPI100082	160	PP-TPR-Acier PP-TPR-Steel	LS / Pegboardable	12/12



PINCE À BEC MULTIFONCTION Long noze plier

Poignée bi-matière antidérapant (PP-TPR) - Non-slip bi-material handles (PP-TPR)
Ressort de rappel - Return spring

REF.	TAILLE (MM) SIZE (MM)	CARACTÉRISTIQUES SPECIFICATIONS	CONDITIONNEMENT PACKING	UV/PCB
BPI100182	160	PP-TPR-Acier PP-TPR-Steel	LS / Pegboardable	12/12



BOÎTE À OUTILS MAGNÉTIQUES Magnetic tools'kit

Boîte à outils magnétiques de précision - Magnetic tools'kit
70 pièces - 70 pieces

- ⊕ PH00 PH0 PH1 PH2
- 1.0 1.5 2.0 2.5 3.0 3.5 4.0 CR-V5 CR-V6 CR-V7
- ⊗ CR-V T10 CR-V T15 CR-V T20 CR-V T25 CR-V T30
- ⊛ T-3 T-4 T-5 T-6 T-7 T-8 T-9 T-10 T-15 T-20
- H0.9 H1.3 H1.5 H2.0 H2.5 H3.0 H4.0 ⚙ 2.0 ⚙ CR-V1 ⚙ 2.6
- 2.5 3.0 3.5 4.0 4.5 5.0 5.5 6.0 7.0 8.5 9.0 10.0 11.0 12.0 13.0

REF.	TAILLE (MM) SIZE (MM)	CARACTÉRISTIQUES SPECIFICATIONS	CONDITIONNEMENT PACKING	UV/PCB
900050	-	PP-TPR-Acier PP-TPR-Steel	Vrac / Bulk	1/20

MÈTRES À RUBAN & RÉGLETS / MEASURING TAPES & RULERS



MÈTRES À RUBAN Measuring tapes

Largeur ruban - Tape width

BME030081 : 16 mm - **BME050081** : 19 mm - **BME080081** : 25 mm

Boîtier ABS/TPR - ABS/TPR case

Retour automatique - Automatic tape return

Double système de blocage de ruban - Double lock system

Avec clip de ceinture et dragonne - With belt-clip and strap

REF.	LONGUEUR (M) LENGTH (M)	CARACTÉRISTIQUES SPECIFICATIONS	CONDITIONNEMENT PACKING	LIV/PCB
BME030081	3	ABS-TPR-Acier ABS-TPR-Steel	Vrac / Bulk	12/120
BME050081	5	ABS-TPR-Acier ABS-TPR-Steel	Vrac / Bulk	12/72
BME080081	8	ABS-TPR-Acier ABS-TPR-Steel	Vrac / Bulk	6/36

DÉCAMÈTRES Decameters

Ruban fibre de verre souple - Flexible glass fibre tape

Boîtier ABS avec crochet - ABS box with hook

Manivelle escamotable - Folding handle

REF.	LONGUEUR (M) LENGTH (M)	CARACTÉRISTIQUES SPECIFICATIONS	CONDITIONNEMENT PACKING	LIV/PCB
BME100061	10	ABS-Fibre de verre ABS-Fiberglass	Vrac / Bulk	1/50
BME200061	20	ABS-Fibre de verre ABS-Fiberglass	Vrac / Bulk	1/50

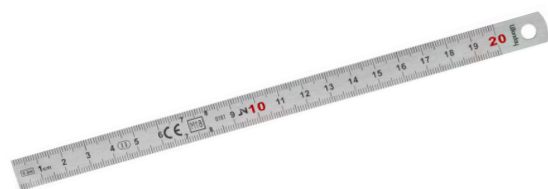

RÉGLETS FLEXIBLES Flexible rulers

2 faces graduées - 2 graduated sides

1 face en mm, 1 face en 1/2 mm - 1 side in mm, 1 side in 1/2 mm

10 - 15 - 20 & 30 cm : section 13 x 0,5 mm

50 cm : section 20 x 0,5 mm

REF.	LONGUEUR (CM) LENGTH (CM)	CARACTÉRISTIQUES SPECIFICATIONS	CONDITIONNEMENT PACKING	LIV/PCB
BRE100072	10	Inox Stainless steel	LS / Pegboardable	10/200
BRE150172	15	Inox Stainless steel	LS / Pegboardable	10/150
BRE200072	20	Inox Stainless steel	LS / Pegboardable	10/150
BRE300072	30	Inox Stainless steel	LS / Pegboardable	10/150
BRE500072	50	Inox Stainless steel	LS / Pegboardable	10/100

RÉGLETS MÉTRIQUES Metric rulers

Inox semi-rigide - Semi-rigid stainless steel

1 face graduée : 1 bord en mm, 1 bord en 1/2 mm - Frontside graduated : 1 side in mm, 1 side in 1/2 mm

1 face avec la table des conversions - Backside with conversion table
Section 25 x 1 mm

REF.	LONGUEUR (CM) LENGTH (CM)	CARACTÉRISTIQUES SPECIFICATIONS	CONDITIONNEMENT PACKING	LIV/PCB
BRE310072	30	Inox Stainless steel	LS / Pegboardable	10/150
BRE510072	50	Inox Stainless steel	LS / Pegboardable	10/100
BRE000071	100	Inox Stainless steel	Vrac / Bulk	10/60
BRE010071	150	Inox Stainless steel	Vrac / Bulk	10/30
BRE020071	200	Inox Stainless steel	Vrac / Bulk	10/30

CERCLEUSE À MAIN & ADHÉSIFS / HAND STRAPPING & ADHESIVE



CERCLEUSE À MAIN AVEC BATTERIE ET CHARGEUR Hand strapping with battery and charger

Avec batterie 14V 4.0Ah et chargeur - With 14V 4.0Ah battery and charger
Tension : 900 N - 3200 N - Tension: 900 N - 3200 N
Vitesse de tension : 100 - 200 mm/s - Tension speed: 100 - 200 mm/s
Poids : 3,1 kg - Weight : 3,1 kg
Largeur soudure : de 13 à 16 mm - Width welding: 13 to 16 mm
Épaisseur soudure : de 0,4 à 1,2 mm - Thickness welding: 04 to 1.2 mm
Plateau de soudure en alliage résistant - Welding plate in resistant alloy
500 soudures avec une charge de batterie - 500 welds with one battery charge

REF.	DIM. (HXLXPMM)	CARACTÉRISTIQUES SPECIFICATIONS	CONDITIONNEMENT PACKING	UV/PCB
GCE000063	380 x 130 x 130 mm		Boîte / Box	1/24



DÉVIDOIRS PROFESSIONNELS Professional tape dispensers

Système auto-rétractable de la lame - Self-retracting blade system
Mandrin : Ø 50 mm - Core : Ø 50 mm
Pour rouleaux 66 m & 100 m (non inclus) - For 66 m & 100 m rolls (not included)

REF.	DIM. (HXLXPMM)	CARACTÉRISTIQUES SPECIFICATIONS	CONDITIONNEMENT PACKING	UV/PCB
GAD900263	-	PP	Boîte / Box	1/24
GAD900383	-	PLI-TPR	Boîte / Box	1/24

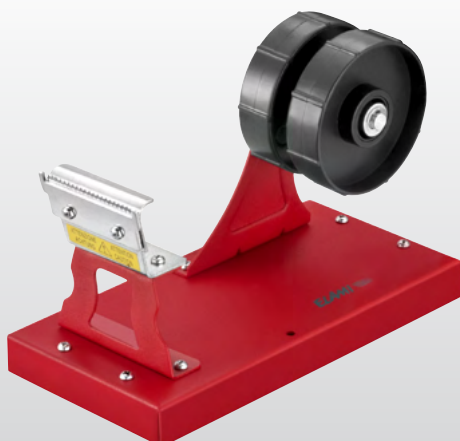

ELAMI

DÉVIDOIR 2 ROULEAUX 2 rolls tape dispenser

Dévidoir lourd 2 rouleaux en métal - 2-rolls heavy tape dispenser
Pour rouleaux 25 mm x 66 m et 100 m (non inclus) - For 25 mm x 66 m and 100 m rolls (not included)

REF.	DIM. (HXLXPMM)	CARACTÉRISTIQUES SPECIFICATIONS	CONDITIONNEMENT PACKING	UV/PCB
900046	200 x 100 x 130	Acier-PP Steel-PP	Boîte / Box	1/6

BRICOLER - JARDINER

Tinker - Garden



ROULEAUX DE RUBANS ADHÉSIF 50 MM X 66 M - Adhesive tape rolls 50 mm x 66 m

Mandrin carton - Cardboard mandrel

MODÈLE MODEL	REF.	TAILLE / ÉPAISSEUR SIZE / THICKNESS	CARACTÉRISTIQUES SPECIFICATIONS	CONDITIONNEMENT PACKING	LIV/PCB	
HAVANE «ECO» «ECO» BROWN	GAD300011	50mm x 66m 45 microns	BOPP		Vrac / Bulk	6/36
HAVANE «SILENCIEUX» «NOISELESS» BROWN	GAD300111	50mm x 66m 45 microns	BOPP		Vrac / Bulk	6/36
BLANC «FRAGILE» «FRAGILE» WHITE	GAD200011	50mm x 66m 50 microns	BOPP		Vrac / Bulk	6/36
BLANC «GARANTIE» «GARANTIE» WHITE	GAD200111	50mm x 66m 50 microns	BOPP		Vrac / Bulk	6/36
TRANSPARENT CLEAR	GAD100011	50mm x 66m 50 microns	BOPP		Vrac / Bulk	6/36
BLEU BLUE	GAD400011	50mm x 66m 45 microns	BOPP		Vrac / Bulk	6/36
VERT GREEN	GAD400111	50mm x 66m 45 microns	BOPP		Vrac / Bulk	6/36
ROUGE RED	GAD400211	50mm x 66m 45 microns	BOPP		Vrac / Bulk	6/36
JALINE YELLOW	GAD400311	50mm x 66m 45 microns	BOPP		Vrac / Bulk	6/36



ROULEAUX DE RUBAN - Tape rolls

Mandrin carton certifié recyclé - Cardboard mandrel-certified recycled

MODÈLE MODEL	REF.	TAILLE / ÉPAISSEUR SIZE / THICKNESS	CARACTÉRISTIQUES SPECIFICATIONS	CONDITIONNEMENT PACKING	LIV/PCB	
MARQUAGE AU SOL FLOOR MARKINGS	GAD700011	48mm x 50m 130 microns	PVC		Vrac / Bulk	6/24
	GAD700111	48mm x 50m 130 microns	PVC		Vrac / Bulk	6/24
MARQUAGE AU SOL ANTIDERAPANT NON-SLIP FLOOR MARKINGS	GAD700311	50mm x 20m 800 microns	PVC / CARBURE DE SILICIUM PVC / Silicon carbide		Vrac / Bulk	1/18
BALISAGE (Non adhésif) WARNING (Non adhesive)	GAD750001	48mm x 50m 50 microns	PE		Vrac / Bulk	1/36
	GAD750101	48mm x 50m 50 microns	PE		Vrac / Bulk	1/36
KRAFT ADHÉSIF KRAFT ADHESIVE	GAD800011	50mm x 50m 140 microns	PAPIER KRAFT Kraft paper		Vrac / Bulk	6/36

OUTILS DE JARDIN / GARDENING TOOLS

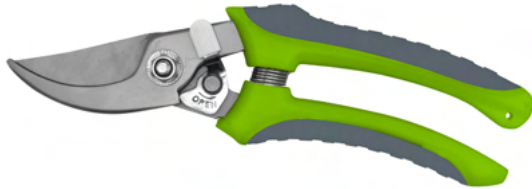

SÉCATEUR ERGONOMIQUE Ergonomical pruning shears

Lames franches incurvées en acier inoxydable 3CR14 - Curved bypass blades 3CR14 stainless steel

Manche bi-matière antidérapant (PP-TPR) - Non-slip bi-material handles (PP-TPR)

Courseur de verrouillage - Safety locking cursor

REF.	TAILLE (CM) SIZE (CM)	CARACTÉRISTIQUES SPECIFICATIONS	CONDITIONNEMENT PACKING	LIV/PCB
WST100082	19,5 cm	Acier inox-PP-TPR Stainless steel-PP-TPR	LS / Pegboardable	12/72



COUPE-FLEURS Flower shears



Idéal pour
couper les tiges

Ideal for
cut the stems

Lame microdentée et encoche en acier inoxydable 3CR14 - Serrated blade 3CR14 stainless steel with notch

Manche bi-matière antidérapant (PP-TPR) - Non-slip bi-material handles (PP-TPR)

Courseur de verrouillage - Safety locking cursor

REF.	TAILLE (CM) SIZE (CM)	CARACTÉRISTIQUES SPECIFICATIONS	CONDITIONNEMENT PACKING	LIV/PCB
WST200282	18,5 cm	Acier inox-PP-TPR Stainless steel-PP-TPR	LS / Pegboardable	12/72



ÉPINETTE Flower and fruit snips

Lame microdentée en acier inoxydable 3CR14 - Serrated blade 3CR14 stainless steel

Manche bi-matière antidérapant (PP-TPR) - Non-slip bi-material handles (PP-TPR)

Courseur de verrouillage - Safety locking cursor

REF.	TAILLE SIZE	CARACTÉRISTIQUES SPECIFICATIONS	CONDITIONNEMENT PACKING	LIV/PCB
WST200182	20 cm	Acier inox-PP-TPR Stainless steel-PP-TPR	LS / Pegboardable	12/72



COUPE-TOUT Garden shears

Lame microdentée en acier inoxydable 3CR14 - Serrated blade 3CR14 stainless steel

Manche mono-matière en PP - PP handle

Courseur de verrouillage - Safety locking cursor

REF.	TAILLE SIZE	CARACTÉRISTIQUES SPECIFICATIONS	CONDITIONNEMENT PACKING	LIV/PCB
WST200062	19 cm	Acier inox-PP Stainless steel-PP	LS / Pegboardable	12/72

BRICOLER - JARDINER

Tinker - Garden



CISEAUX ERGONOMIQUES Ergonomic scissors

Lame dentelée en acier inoxydable 2CR14 - Serrated blade 2CR14 stainless steel
Anneaux bi-matière (PP-TPR) asymétriques et ergonomiques - Soft-grip (PP-TPR) asymmetrical ergonomic handles
Rivet d'autoserrage des lames - Self-tightening blade rivet

REF.	TAILLE SIZE	CARACTÉRISTIQUES SPECIFICATIONS	CONDITIONNEMENT PACKING	UV/PCB
WCI200082	19,5 cm	PP-TPR 	LS Pegboardable	12/120



CISEAUX DE PRÉCISION Precision scissors

Lame microdentée en acier inoxydable 2CR14 revêtu titanium - Serrated blade 2CR14 stainless steel titanium coating
Traitement de surface noir titanium (anti adhésif et longévité de la coupe) - Black titanium coating (non-stick and long cutting life)
Larges anneaux symétriques ABS - ABS wide symmetrical handles
Lames bouts effilés - Sharped end blades

REF.	TAILLE SIZE	CARACTÉRISTIQUES SPECIFICATIONS	CONDITIONNEMENT PACKING	UV/PCB
WCI190062	19 cm	ABS 	LS Pegboardable	12/72

**TAILLE
DE
PRÉCISION**



SCIE À MOUSSE FLORALE Flower foam knife

Lame 28,5 cm en acier inox 2CR14 - 28.5 stainless steel 2CR14 blade
Lame droite non dentelée - Teethless straight blade
Lame protégée par un étui EVA - EVA blade's protection sleeve
Manche mono-matière en PP - PP handle
Mousse non incluse - Foam block non included

REF.	TAILLE SIZE	CARACTÉRISTIQUES SPECIFICATIONS	CONDITIONNEMENT PACKING	UV/PCB
WSM100062	43,3 cm	Acier inox-PP Stainless steel-PP 	LS Pegboardable	6/48





BOÎTE DE 5 COUTEAUX DE FLEURISTE Box of 5 floral knives

Manche mono-matière en PP - PP handle
Lame en acier inoxydable 2CR14 - Stainless steel 2CR14 blade

REF.	TAILLE SIZE	CARACTÉRISTIQUES SPECIFICATIONS	CONDITIONNEMENT PACKING	LIV/PCB
WSE250063	16 cm	Acier inox-PP Stainless steel-PP	Boîte/Box	12/48



SERPETTE FLEURISTE FERMANTE Florist folding knife

Manche mono-matière en PP - PP handle
Lame en acier inoxydable 2CR14 - Stainless steel 2CR14 blade

REF.	TAILLE SIZE	CARACTÉRISTIQUES SPECIFICATIONS	CONDITIONNEMENT PACKING	LIV/PCB
WSE100062	16,7 cm	Acier inox-PP Stainless steel-PP	LS/pegboardable	12/72



DÉSÉPINOIR Thorns removing plier

Pince monobloc acier inoxydable souple 12 cm - Soft stainless steel plier 12 cm one piece
Poignée ergonomique - Ergonomic handle

REF.	TAILLE SIZE	CARACTÉRISTIQUES SPECIFICATIONS	CONDITIONNEMENT PACKING	LIV/PCB
WDN100071	12 cm	Acier inox Stainless steel	Urac/bulk	6/48



PINCE AGRAFEUSE « NORMA » 24/6 26/6 « Norma » 24/6 26/6 plier stapler

Tout métal - Metal plier stapler
Capacité d'agrafage : 20 feuilles - Stapling capacity : 20 sheets

REF.	TAILLE/ SIZE	CARACTÉRISTIQUES SPECIFICATIONS	CONDITIONNEMENT PACKING	LIV/PCB
FAG260072	24/6 26/6	Métal / Metal	LS / Pegboardable	12/48



**RETROUVEZ NOS
ARDOISES ET CRAIES
PAGES 75/76**

BRICOLER - JARDINER

Tinker - Garden



RUBAN ADHÉSIF ISOLANT Insulating adhesive tape

Résistant à l'eau - *Waterproof*
Mandrin carton - *Cardboard mandrel*

REF.	TAILLE SIZE	CARACTÉRISTIQUES SPECIFICATIONS	CONDITIONNEMENT PACKING	UV/PCB
BAD150011	33 m x 15 mm 150 microns	PVC	 Vrac / Bulk	6/192



RUBAN ADHÉSIF FLORAL EN CRÉPON Adhesive flower tape

Imperméable et élastique - *Waterproof and stretch*
Mandrin carton - *Cardboard mandrel*

REF.	TAILLE SIZE	CARACTÉRISTIQUES SPECIFICATIONS	CONDITIONNEMENT PACKING	UV/PCB
WAD130101	27 m x 13 mm	-	 Vrac / Bulk	6/192



RUBAN AUTO-AGRIPPANT EASY SCRATCH Easy Scratch hook and loop tape

Multi-usages intérieur et extérieur - *Multi-purposes for indoor and outdoor*
Réversible et réutilisable - *Reversible and reusable*
Ultra résistant à la traction - *Can withstand extreme pulls*

REF.	TAILLE SIZE	CARACTÉRISTIQUES SPECIFICATIONS	CONDITIONNEMENT PACKING	UV/PCB
766221*	20 mm x 2.5 m	Nylon	 LS / Pegboardable	6/144

* Jusqu'à épaisseur des stocks



TABOURETS / ROLLING STEPSTOOLS

TABOURETS MÉTAL MOBILES

Metal rolling stepstools

Pare-choc caoutchouc - Rubber bumper

2 plateaux avec revêtement caoutchouc antidérapant - 2 non-slip rubber platforms

3 roues escamotables & pivotantes - 3 retractable & swivelling wheels

Charge utile maximum : 150 kg - Loading capacity up to 150 kg

2 hauteurs fixes : 20 & 41 cm - 2 fixed heights : 20 & 41 cm

REF.	DIM. (Ø X H MM)	MÉTAL	CARACTÉRISTIQUES SPECIFICATIONS	CONDITIONNEMENT PACKING	LIV/PCB
GTM200003	Ø 290/430 x 410	Métal Metal		Boîte / Box	1/28
GTM200103	Ø 290/430 x 410	Métal Metal		Boîte / Box	1/28
GTM200203*	Ø 290/430 x 410	Métal Metal		Boîte / Box	1/28
GTM200303	Ø 290/430 x 410	Métal Metal		Boîte / Box	1/28
GTM200403	Ø 290/430 x 410	Métal Metal		Boîte / Box	1/28

* Jusqu'à épuisement des stocks



Position 1



Position 2



Position 3



STEP'MOOV

Tabourets plastiques mobiles avec pare-choc caoutchouc - Monobloc plastic rolling stepstool with rubber bumper

2 plateaux antidérapants - 2 non-slip platforms

3 roues escamotables & pivotantes - 3 retractable & swivelling wheels

Charge utile maximum : 150 kg - Loading capacity up to 150 kg

3 en 1 : hauteur modulable à volonté 24,5 / 37 / 45 cm - 3 in 1 : 3 adjustable heights 24,5 / 37 / 45 cm

REF.	DIM. (Ø X H MM)	PP	CARACTÉRISTIQUES SPECIFICATIONS	CONDITIONNEMENT PACKING	LIV/PCB
GTM150203	Ø 300/455 x 245/370/450	PP		Boîte / Box	1/28
GTM150303	Ø 300/455 x 245/370/450	PP		Boîte / Box	1/28
GTM150403	Ø 300/455 x 245/370/450	PP		Boîte / Box	1/28



MANUTENTION

Handling

TABOURETS PLASTIQUES MOBILES

Plastic rolling stepstool









Pare-choc caoutchouc - Rubber bumpers

2 plateaux antidérapants - 2 non-slip platforms

Charge utile maximum : 150 kg - Loading capacity up to 150 kg

3 roues escamotables & pivotantes - 3 retractable & swivelling wheels

2 hauteurs fixes : 19,5 & 38 cm - 2 fixed heights : 19,5 & 38 cm

REF.	DIM. (Ø X H MM)	CARACTÉRISTIQUES SPECIFICATIONS	CONDITIONNEMENT PACKING	LIV/PCB
GTM100003	Ø 280/405 x 380	PP   	Boîte / Box	1/28
GTM100103	Ø 280/405 x 380	PP   	Boîte / Box	1/28
GTM100203	Ø 280/405 x 380	PP   	Boîte / Box	1/28



TABOO



Tabourets mobiles plastiques monoblocs avec pare-choc caoutchouc -













Monobloc plastic rolling stools with rubber bumper

Plateau antidérapant - Non-slip platform

Charge utile maximum : 150 kg - Loading capacity up to 150 kg

3 roues escamotables & pivotantes - 3 retractable & swivelling wheels

Hauteur fixe : 34,5 cm - Fixed height : 34,5 cm

REF.	DIM. (Ø X H MM)	CARACTÉRISTIQUES SPECIFICATIONS	CONDITIONNEMENT PACKING	LIV/PCB
GTM150003	Ø 295/455 x 330/345	PP    	Boîte / Box	1/20
GTM150103	Ø 295/455 x 330/345	PP    	Boîte / Box	1/20
3500-2R*	Ø 295/455 x 330/345	PP    	Boîte / Box	1/20

* Jusqu'à épuisement des stocks

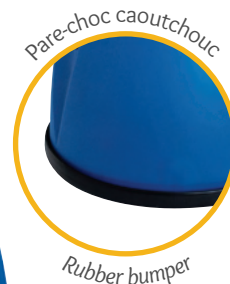

MARCHEPIEDS / STEPSTOOLS

MARCHEPIED ALU Aluminium stepstool

Marchepied pliant structure aluminium : 2 marches - Aluminium foldable
2-step stepstool

Marches striées antidérapantes - Streaked slip-resistant steps

Patins antidérapants - Slip-resistant feet

Charge utile maximum : 150 kg - Loading capacity up to 150 kg

Dimensions marches : 325 x 80 mm - Steps size : 325 x 80 mm

Dimensions plateforme : 345 x 200 mm - Platform size : 345 x 200 mm



REF.	DIM. (H) POIDS	CARACTÉRISTIQUES SPECIFICATIONS	CONDITIONNEMENT PACKING	UV/PCB
GTM320073	470 mm 1,9 kg	Aluminium Aluminum   	Vrac / Bulk	1/6



Handling

ESCABEAUX / STEPLADDERS



ESCABEAUX ACIER LAQUÉ** Lacquered steel stepladders

Escabeau pliant acier laqué époxy blanc : 2, 3 ou 4 marches - White epoxy-lacquered steel 2/3-step stepladders

Patins caoutchouc antidérapants - Slip-resistant rubber feet

Charge utile maximum : 150 kg - Loading capacity up to 150 kg

Marches métal antidérapantes - Non-slip metal steps

Dimensions marches : 300 x 200 mm - Steps size : 300 x 200 mm

REF.	DIM. (H) POIDS	CARACTÉRISTIQUES SPECIFICATIONS	CONDITIONNEMENT PACKING	UV/PCB
BES620073*	470 mm 4,2 kg	Acier Steel epoxy	2 150 kg	Vrac / Bulk 1/6

* Jusqu'à épuisement des stocks



ESCABEAUX ACIER LAQUÉ** Lacquered steel stepladders

Escabeau pliant acier laqué époxy blanc : 2 ou 3 marches - White epoxy-lacquered steel 2/3-step stepladders

Patins caoutchouc antidérapants - Slip-resistant rubber feet

Charge utile maximum : 150 kg - Loading capacity up to 150 kg

Marches métal avec revêtement antidérapant - Metal steps with non-slip surface

Dimensions marches : 300 x 200 mm - Steps size : 300 x 200 mm

REF.	DIM. (H) POIDS	CARACTÉRISTIQUES SPECIFICATIONS	CONDITIONNEMENT PACKING	UV/PCB
BES720073	470 mm 4,2 kg	Acier-TPR Steel epoxy-TPR	2 150 kg	Vrac / Bulk 1/6
BES730073	700 6,1 kg	Acier-TPR Steel epoxy-TPR	3 150 kg	Vrac / Bulk 1/4

ESCABEAUX ACIER LAQUÉ & GARDE-CORPS** Lacquered steel stepladders with safety guard rail

Escabeau pliant acier laqué époxy blanc : 2 ou 3 marches - White epoxy-lacquered steel 2/3-step stepladders

Patins caoutchouc antidérapants - Slip-resistant rubber feet

Charge utile maximum : 150 kg - Loading capacity up to 150 kg

Marches métal avec revêtement antidérapant - Metal steps with non-slip surface

Grand garde-corps - Large & tall safety guard rail

Dimensions marches : 378 x 260 mm - Steps size : 378 x 260 mm

REF.	DIM. (H) POIDS	CARACTÉRISTIQUES SPECIFICATIONS	CONDITIONNEMENT PACKING	UV/PCB
BES820073	470 mm 5,3 kg	Acier-TPR Steel epoxy-TPR	2 150 kg	Vrac / Bulk 1/3
BES830073	700 7,6 kg	Acier-TPR Steel epoxy-TPR	3 150 kg	Vrac / Bulk 1/3



ESCABEAUX SUPER PLUS**

Echelles doubles de 3 à 8 marches à un plan de montée structure en aluminium avec porte-outils - Aluminium stepladders with closing tool holder
 Marches striées antidérapantes & garde-corps - Streaked slip-resistant steps & safety rail
 Patins antidérapants - Slip-resistant feet
 Charge utile maximum : 150 kg - Loading capacity up to 150 kg
 2 sangles de sécurité (modèles 5, 6, 7 & 8 marches) - 2 safety belts (5, 6, 7 & 8 steps)

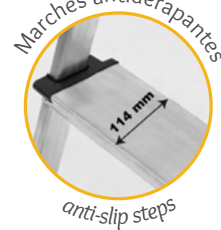

REF.	CARACTÉRISTIQUES SPECIFICATIONS	CONDITIONNEMENT PACKING	UV/PCB
BES533073	Aluminium Aluminum	Vrac / Bulk	1/1
BES543073	Aluminium Aluminum	Vrac / Bulk	1/1
BES553073	Aluminium Aluminum	Vrac / Bulk	1/1
BES563073	Aluminium Aluminum	Vrac / Bulk	1/1
BES573073	Aluminium Aluminum	Vrac / Bulk	1/1
BES583073	Aluminium Aluminum	Vrac / Bulk	1/1

3	0,57 m	1,24 m	0,41 m	1,32 m	0,14 m	3,97
4	0,79 m	1,45 m	0,45 m	1,55 m	0,14 m	4,78
5	1,02 m	1,67 m	0,48 m	1,78 m	0,14 m	5,61
6	1,23 m	1,88 m	0,50 m	1,93 m	0,14 m	6,54
7	1,44 m	2,10 m	0,53 m	2,24 m	0,14 m	7,39
8	1,65 m	2,31 m	0,59 m	2,47 m	0,14 m	8,28



Handling



ESCABEAUX STANDARD PLUS**



Echelles doubles 4 et 5 marches à un plan de montée structure aluminium avec porte-outils - Aluminium stepladders with tool holder
 Marches striées antidérapantes & garde-corps - Streaked slip-resistant steps & safety rail
 Patins antidérapants - Slip-resistant feet
 Charge utile maximum : 150 kg - Loading capacity up to 150 kg
 Usage domestique - Household use

REF.	CARACTÉRISTIQUES SPECIFICATIONS	CONDITIONNEMENT PACKING	LV/PCB
BES150073	Aluminium Aluminum	Vrac / Bulk	1/1









5	1,08 m	3,08 m	1,88 m	4,44



ESCABEAUX ALU PRO**







Usage professionnel - Professional use
 Echelles doubles de 3 à 9 marches à un plan de montée structure aluminium -
 Aluminium stepladders 3 to 9 steps
 Rampes de sécurité (modèles 8 & 9 marches) - Safety handrails (8 & 9 steps)
 - Long. 1,10 m
 Soudage robotique - Robotic welding
 Marches striées antidérapantes extra-larges 120 mm - Extra deep tread
 aluminium & slip-resistant steps 120 mm
 Charnières haute qualité & porte-outils - High quality hinges & tool holder
 Charge utile maximum : 150 kg - Loading capacity up to 150 kg
 Sangles de sécurité - Safety belts
 Patins emboîtables antidérapants - Slip-resistant feet

REF.	CARACTÉRISTIQUES SPECIFICATIONS	CONDITIONNEMENT PACKING	UV/PCB
BES530073*	Aluminium Aluminum   	Vrac / Bulk	1/1
BES580173	Aluminium Aluminum   	Vrac / Bulk	1/1
BES590073	Aluminium Aluminum   	Vrac / Bulk	1/1

* Jusqu'à épuisement des stocks



				
3	0,68 m	2,68 m	1,41 m	5,69
8	1,83 m	3,83 m	2,67 m	11,98
9	2,06 m	4,06 m	2,92 m	14,07



MANUTENTION

Handling

DIABLES / HAND TRUCKS



DIABLERET TÉLESCOPIQUE 80 KG

Diableret pliable poignée télescopique - Folding hand truck with telescopic handle
 Tubes acier finition époxy - Tubular steel frame with epoxy finish
 2 roues pleines PEHD Ø 150 mm sur jantes plastiques - 2 HDPE solid wheels 150 mm Ø on plastic rims
 Charge utile maximum : 80 kg - Loading capacity up to 80 kg
 1 bavette acier rabattable : 385 x 280 mm - 1 folding steel platform : 385 x 280 mm

REF.	DIM. (LXPXHMM)	CARACTÉRISTIQUES SPECIFICATIONS	CONDITIONNEMENT PACKING	LV/PCB
MDI100271	410 x 165 x 695 410 x 570 x 1035	Acier Steel	80 kg	Vrac / Bulk 1/1
MDI900061	Roue/Wheel Ø 150	PEHD HDPE		Vrac / Bulk 1/1



DIABLES ALUMINIUM - Aluminum hand trucks

50 KG

Diable pliant structure aluminium - Aluminum folding hand truck
 2 roues bandage TPR Ø 120 mm sur jantes plastiques - 2 TPR wheels 120 mm Ø on plastic rims
 Roues escamotables - Retractable wheels
 Charge utile maximum : 50 kg - Loading capacity up to 50 kg
 1 bavette aluminium rabattable : 385 x 280 mm - 1 folding aluminium platform : 385 x 280 mm
 Poignée de transport télescopique - Telescopic carry handle
 1 élastique sandow inclus - 1 sandow elastic band supplied

REF.	DIM. (LXPXHMM)	CARACTÉRISTIQUES SPECIFICATIONS	CONDITIONNEMENT PACKING	LV/PCB
MDI100371	390 x 50 x 630 390 x 400 x 1000	Aluminium-TPR Aluminum-TPR	50 kg	Vrac / Bulk 1/4



ESCALIER 3 ROUES - 30 KG/70 KG Stair-climbing 3 wheels - 30 kg/70 kg

Diable escalier pliable - Foldable stair-climbing cart
 2 x 3 roues bandage TPR sur jantes aluminium - 2 x 3 TPR wheels on aluminum rims
 Roues escamotables - Retractable wheels
 Charge utile maximum : 70 kg sur surface plane - 30 kg en montée d'escalier
 Loading capacity up to : 70 kg for flat floor - 30 kg during climbing stairs
 1 bavette aluminium rabattable : 385 x 280 mm - 1 folding aluminium platform : 385 x 280 mm
 Poignée de transport télescopique - Telescopic carry handle
 1 élastique sandow inclus - 1 sandow elastic band supplied

REF.	DIM. (LXPXHMM)	CARACTÉRISTIQUES SPECIFICATIONS	CONDITIONNEMENT PACKING	LV/PCB
MDI100071	445 x 470 x 100 445 x 685 x 1000	Aluminium-TPR Aluminum-TPR	70 kg	Vrac / Bulk 1/4

DIABLES ACIER - Steel hand trucks

100 KG

Diable pliable structure acier - Steel folding hand truck
2 roues bandage TPR Ø 175 mm sur jantes plastiques - 2 TPR wheels 175 mm Ø on plastic rims
Roues escamotables - Retractable wheels
Charge utile maximum : 100 kg - Loading capacity up to 100 kg
1 bavette aluminium rabattable : 355 x 320 mm - 1 folding aluminium platform : 355 x 320 mm
Poignée de transport télescopique - Telescopic carry handle
1 élastique sandow inclus - 1 sandow elastic band supplied

REF.	DIM. (LXPXHMM)	CARACTÉRISTIQUES SPECIFICATIONS	CONDITIONNEMENT PACKING	UV/PCB
MDI100171	490 x 60 x 840 490 x 510 x 1110	Métal-PP Metal-PP	 100 kg	Vrac / Bulk 1/2



125 KG

Diable pliable structure aluminium poignée télescopique - Aluminium folding hand truck with telescopic handle
2 roues bandage TPR Ø 180 mm sur jantes plastiques - 2 TPR wheels 180 mm Ø on plastic rims
Roues escamotables - Retractable wheels
Charge utile maximum : 125 kg - Loading capacity up to 125 kg
1 bavette aluminium rabattable : 485 x 350 mm - 1 folding aluminium platform : 485 x 350 mm
Poignée de transport plastique - Plastic carry handle
1 élastique sandow inclus - 1 sandow elastic band supplied

REF.	DIM. (LXPXHMM)	CARACTÉRISTIQUES SPECIFICATIONS	CONDITIONNEMENT PACKING	UV/PCB
MDI100571	500 x 65 x 750 510 x 520 x 1090	Aluminium-PP Aluminum-PP	 125 kg	Vrac / Bulk 1/1



200 KG

Diable pliable structure aluminium renforcée poignée télescopique - Reinforced aluminium folding hand truck with telescopic handle
2 roues bandage TPR Ø 200 mm sur jantes plastiques - 2 TPR wheels 200 mm Ø on plastic rims
Roues escamotables - Retractable wheels
Charge utile maximum : 200 kg - Loading capacity up to 200 kg
1 bavette aluminium rabattable : 590 x 390 mm - 1 folding aluminium platform : 590 x 390 mm
Poignées escamotables grip antidérapantes - Anti-slip grip folding handles

REF.	DIM. (LXPXHMM)	CARACTÉRISTIQUES SPECIFICATIONS	CONDITIONNEMENT PACKING	UV/PCB
MDI100671	595 x 100 x 1020 600 x 600 x 1260	Aluminium-PP Aluminum-PP	 200 kg	Vrac / Bulk 1/1





MANUTENTION

Handling

Diablos - Hand trucks

ESCALIER 3 ROUES - 80 KG/100 KG Stair-climbing 3 wheels - 80 kg/100 kg

Diable escalier structure en tubes d'acier laqués - Tubular lacquered steel frame stairway hand truck
 2 x 3 roues bandage TPR Ø 160 mm sur jantes plastiques - 2 x 3 TPR wheels 160 mm Ø on plastic rims
 Charge utile maximum : 100 kg sur surface plane - 80 kg en montée d'escalier
 Loading capacity up to : 100 kg for flat floor - 80 kg during climbing stairs
 1 bavette acier rabattable : 540 x 330 mm - 1 folding steel platform : 540 x 330 mm
 1 bavette acier fixe : 400 x 190 mm - 1 fixed steel platform : 400 x 190 mm

REF.	DIM. (LxPxHMM)	CARACTÉRISTIQUES SPECIFICATIONS	CONDITIONNEMENT PACKING	UV/PCB
MDI200571	550 x 540 x 1175 550 x 900 x 1175	Acier Steel epoxy	 80 kg Vrac / Bulk	1/1
MDI900161	Roue/Wheel Ø 152	TPR-PP	 Vrac / Bulk	1/1



ESCALIER 3 ROUES - 120 KG/200 KG Stair-climbing 3 wheels - 120 kg/200 kg

Diable escalier structure en tube d'acier - Tubular steel frame stairway hand truck
 2 x 3 roues bandage TPR Ø 150 mm sur jantes plastiques - 2 x 3 TPR wheels 150 mm Ø on plastic rims
 Charge utile maximum : 200 kg usage normal - 120 kg en montée d'escalier
 Loading capacity up to : 200 kg for normal using - 120 kg during climbing stairs
 1 bavette acier antidérapante rabattable : 350 x 280 mm - 1 folding antislip steel platform : 350 x 280 mm
 Poignées caoutchouc anti écrasement - Anti-crushing soft-rubber handles
 Dimensions plié (LxPxH) : 430 x 525 x 848 mm - Foldable size (LxWxH) : 430 x 525 x 848 mm
 Dimensions déplié (LxPxH) : 653 x 525 x 1150 mm - Overall size (LxWxH) : 653 x 525 x 1150 mm
 Système de verrouillage bavette - Platform locking system

REF.	DIM. (LxPxHMM)	CARACTÉRISTIQUES SPECIFICATIONS	CONDITIONNEMENT PACKING	UV/PCB
MDI200671	525 x 430 x 848 525 x 653 x 1150	Acier Steel	 120 kg Vrac / Bulk	1/1



DIABLES ACIER LAQUÉ - Steel epoxy hand trucks

250 KG



Diable structure acier finition époxy - Steel frame hand truck with epoxy finish
2 roues gonflables pneumatiques Ø 255 mm sur jantes plastiques - 2 air-wheels rubber tyres 255 mm Ø on plastic rims

Charge utile maximum : 250 kg - Loading capacity up to 250 kg

1 bavette acier fixe : 400 x 150 mm - 1 fixed steel platform : 400 x 150 mm

1 bavette acier rabattable : 520 x 325 mm - 1 folding steel platform : 520 x 325 mm

Poignées plastique - Plastic handles

REF.	DIM. (LXPXHMM)	CARACTÉRISTIQUES SPECIFICATIONS	CONDITIONNEMENT PACKING	UV/PCB	
MDI200071	590 x 454 x 1100 590 x 816 x 1100	Acier laqué Steel epoxy	 250 kg	Vrac / Bulk	1/1
MDI900361	Roue/Wheel Ø 254	Caoutchouc-PP Rubber-PP		Vrac / Bulk	1/1



250 KG



Diable structure acier finition époxy - Steel frame hand truck with epoxy finish
2 roues pleines bandage TPR Ø 255 mm sur jantes plastiques - 2 solid TPR wheels 255 mm Ø on plastic rims

Charge utile maximum : 250 kg - Loading capacity up to 250 kg

1 bavette acier fixe : 400 x 150 mm - 1 fixed steel platform : 400 x 150 mm

1 bavette acier rabattable : 520 x 325 mm - 1 folding steel platform : 520 x 325 mm

Poignées plastiques - Plastic handles

REF.	DIM. (LXPXHMM)	CARACTÉRISTIQUES SPECIFICATIONS	CONDITIONNEMENT PACKING	UV/PCB	
MDI200171	560 x 450 x 1100 560 x 810 x 1100	Acier laqué Steel epoxy	 250 kg	Vrac / Bulk	1/1
MDI900461	Roue/Wheel Ø 250	TPR-PP		Vrac / Bulk	1/1



300 KG



Diable structure acier finition époxy - Steel frame hand truck with epoxy finish
2 roues gonflables pneumatiques Ø 255 mm sur jantes plastiques - 2 air-wheels rubber tyres 255 mm Ø on plastic rims

Charge utile maximum : 300 kg - Loading capacity up to 300 kg

1 bavette acier fixe : 470 x 270 mm - 1 fixed steel platform : 470 x 270 mm

1 bavette acier rabattable : 430 x 390 mm - 1 folding steel platform : 430 x 390 mm

Poignées plastiques anti écrasement - Anti-crushing plastic handles

REF.	DIM. (LXPXHMM)	CARACTÉRISTIQUES SPECIFICATIONS	CONDITIONNEMENT PACKING	UV/PCB	
MDI200471	650 x 730 x 1200	Acier laqué Steel epoxy	 300 kg	Vrac / Bulk	1/1
MDI900561	Roue/Wheel Ø 255	Caoutchouc-PP Rubber-PP		Vrac / Bulk	1/1



MANUTENTION

Handling

DIABLES ACIER LAQUÉ - Steel epoxy hand trucks





180 KG

Diable structure acier finition époxy - Steel frame hand truck with epoxy finish
2 roues gonflables pneumatiques Ø 255mm sur jantes plastiques - 2 air-wheels rubber tyres 300 mm Ø on plastic rims

Charge utile maximum : 180 kg - Loading capacity up to 180 kg

1 bavette acier fixe : 315 x 230 mm - 1 fixed steel platform : 315 x 230 mm

Poignées plastiques anti écrasement - Anti-crushing plastic handles

REF.	DIM. (LXPXHMM)	CARACTÉRISTIQUES SPECIFICATIONS	CONDITIONNEMENT PACKING	LIV/PCB
MDI200271	495 x 525 x 1180	Acier laqué Steel epoxy 	Vrac / Bulk	1/1
MDI900261	Roue/Wheel Ø 255	Caoutchouc-PP Rubber-PP 	Vrac / Bulk	1/1



250 KG

Diable structure acier finition époxy - Steel frame hand truck with epoxy finish
2 roues gonflables pneumatiques Ø 255 mm sur jantes plastiques - 2 air-wheels rubber tyres 255 mm Ø on plastic rim

Charge utile maximum : 250 kg - Loading capacity up to 250 kg

1 bavette acier fixe : 315 x 230 mm - 1 fixed steel platform : 315 x 230 mm

Poignées caoutchouc - Rubber handles

REF.	DIM. (LXPXHMM)	CARACTÉRISTIQUES SPECIFICATIONS	CONDITIONNEMENT PACKING	LIV/PCB
MDI200371	510 x 502 x 1050	Acier laqué Steel epoxy 	Vrac / Bulk	1/1
MDI900661	Roue/Wheel Ø 255	Caoutchouc-PP Rubber-PP 	Vrac / Bulk	1/1



CHARIOTS / PLATFORM TROLLEYS

Chariot pliable structure en tube d'acier - Tubular steel frame foldable platform trolley

Dossier de poussée rabattable par pression sur la barre horizontale (déverrouillage au pied) - Foldable backrest with foot pressure on the bottom bar

Système de protection anti pincement à la base du dossier - Anti-pinching protective system on the handle

Plateforme acier embouti renforcé avec tapis PVC bleu antidérapant - Superior pressed steel platform with blue non-slipping PVC carpet

4 roues pleines bandage TPR sur jantes nylon - 4 TPR solid wheels on nylon rims
Roues multidirectionnelles : 2 fixes & 2 pivotantes - Multidirectional wheels : 2 fixed & 2 swivelling

Pare-choc de protection caoutchouc - TPR protection bumper

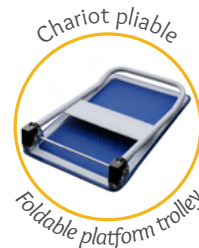

PROFESSIONNEL PLUS 150 KG

Professional Plus 150 kg

Roues silencieuses Ø 100 mm - Noiseless wheels 100 mm Ø

Charge utile maximum : 150 kg - Loading capacity up to 150 kg

Dimensions plateforme : 725 x 465 mm - Platform size : 725 x 465 mm

REF.	DIM. (LxPxHMM)	CARACTÉRISTIQUES SPECIFICATIONS	CONDITIONNEMENT PACKING	UV/PCB
MCH501471	725 x 465 x 245 725 x 465 x 870	Acier-PVC Steel-PVC	Vrac / Bulk	1/1
MCH901561	Roue fixe Fixed wheel Ø 100 (4")	TPR-Nylon	Vrac / Bulk	1/1
MCH901661	Roue pivotante Swivelling wheel Ø 100 (4")	TPR-Nylon	Vrac / Bulk	1/1



PROFESSIONNEL PLUS 300 KG

Professional Plus 300 kg

Roues silencieuses Ø 130 mm - Noiseless wheels 130 mm Ø

Charge utile maximum : 300 kg - Loading capacity up to 300 kg

Dimensions plateforme : 907 x 608 mm - Platform size : 907 x 608 mm

REF.	DIM. (LxPxHMM)	CARACTÉRISTIQUES SPECIFICATIONS	CONDITIONNEMENT PACKING	UV/PCB
MCH500671	907 x 608 x 300 907 x 608 x 860	Acier-PVC Steel-PVC	Vrac / Bulk	1/1
MCH901361	Roue fixe Fixed wheel Ø 130 (5")	TPR-Nylon	Vrac / Bulk	1/1
MCH901461	Roue pivotante Swivelling wheel Ø 130 (5")	TPR-Nylon	Vrac / Bulk	1/1



MANUTENTION

Handling

CARGO 300 KG

Chariot pliable structure en tube d'acier - Tubular steel frame foldable platform trolley
Dossier de poussée rabattable par pression sur la barre horizontale (déverrouillage au pied) - Foldable backrest with foot pressure on the bottom bar
Plateau acier embouti avec tapis PVC antidérapant - Pressed steel platform with non-slipping PVC carpet
4 roues multidirectionnelles Ø 125 mm : 2 fixes & 2 pivotantes - 4 multidirectional wheels 125 mm Ø : 2 fixed & 2 swivelling
Charge utile maximum : 300 kg - Loading capacity up to 300 kg
Pare-chocs de protection - Protection bumpers
Dimensions plateforme : 907 x 608 mm - Platform size : 907 x 608 mm

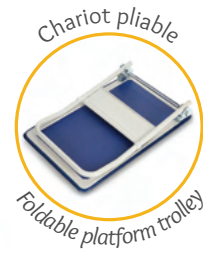

Roues PU sur jantes plastiques avec cache métal - PU wheels on plastic rims with steel cover

REF.	DIM. (LXPXHMM)	CARACTÉRISTIQUES SPECIFICATIONS	CONDITIONNEMENT PACKING	LIV/PCB	
MCH500171	910 x 610 x 150 910 x 610 x 860	Acier-PVC Steel-PVC	300 kg	Vrac / Bulk	1/1
MCH500871	907 x 608 x 290 907 x 608 x 850	Acier-PVC Steel-PVC	300 kg	Vrac / Bulk	1/1
MCH900771	Roue fixe Fixed wheel Ø 125 (5")	PU-PP		Vrac / Bulk	1/1
MCH900871	Roue pivotante Swivelling wheel Ø 125 (5")	PU-PP		Vrac / Bulk	1/1



Roues PVC sur jantes plastiques - PVC wheels on plastic rims
Roues silencieuses - Noiseless wheels

REF.	DIM. (LXPXHMM)	CARACTÉRISTIQUES SPECIFICATIONS	CONDITIONNEMENT PACKING	LIV/PCB	
MCH500571	907 x 608 x 290 907 x 608 x 850	Acier-PVC Steel-PVC	300 kg	Vrac / Bulk	1/1
MCH900971	Roue fixe Fixed wheel Ø 125 (5")	PVC-PP		Vrac / Bulk	1/1
MCH901071	Roue pivotante Swivelling wheel Ø 125 (5")	PVC-PP		Vrac / Bulk	1/1



Chariot pliable structure en tube d'acier - Tubular steel frame foldable platform trolley
Dossier de poussée rabattable par pression sur la barre horizontale (déverrouillage au pied) - Foldable backrest with foot pressure on the bottom bar
Plateforme acier embouti renforcé avec tapis PVC noir antidérapant - Superior pressed steel platform with black non-slipping PVC carpet
Roues multidirectionnelles : 2 fixes & 2 pivotantes avec freins - Multidirectional wheels : 2 fixed & 2 swivelling with brake function
Poignée revêtement mousse & pare-chocs de protection - Soft-foam handles & protection bumpers
Porte outils/documents - Metal tool case for storage
Pare-choc de protection TPR - TPR protection bumper
Kit visserie inclus (vis et outils) - Screw kit included (screw and tools)

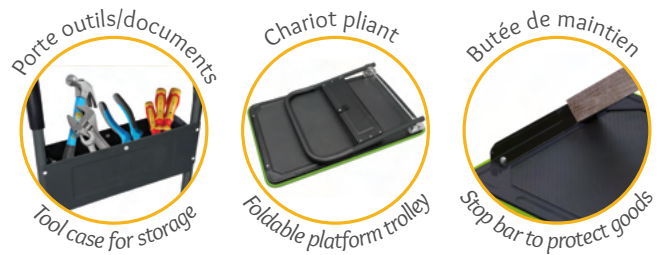

PROFESSIONNEL 150 KG Professional 150 kg



Roues Ø 100 mm - Wheels 100 mm Ø
4 roues pleines bandage TPR sur jantes plastiques - 4 TPR solid wheels on plastic rims
Charge utile maximum : 150 kg - Loading capacity up to 150 kg
Dimensions plateforme : 730 x 470 mm - Platform size : 730 x 470 mm

REF.	DIM. (LXPXHMM)	CARACTÉRISTIQUES SPECIFICATIONS	CONDITIONNEMENT PACKING	UV/PCB
MCH500271	730 x 470 x 230 730 x 470 x 830	Acier-PVC Steel-PVC	Vrac / Bulk	1/1
MCH901961	Roue fixe Fixed wheel Ø 100 (4")	TPR-PP	Vrac / Bulk	1/1
MCH902061	Roue pivotante Swivelling wheel Ø 100 (4")	TPR-PP	Vrac / Bulk	1/1



PROFESSIONNEL 300 KG Professional 300 kg

Roues Ø 125 mm - Wheels 125 mm Ø
4 roues pleines bandage TPR sur jantes plastiques - 4 TPR solid wheels on plastic rims
Charge utile maximum : 300 kg - Loading capacity up to 300 kg
Dimensions plateforme : 900 x 600 mm - Platform size : 900 x 600 mm

REF.	DIM. (LXPXHMM)	CARACTÉRISTIQUES SPECIFICATIONS	CONDITIONNEMENT PACKING	UV/PCB
MCH501171	900 x 600 x 275 900 x 600 x 845	Acier-PVC Steel-PVC	Vrac / Bulk	1/1
MCH901761	Roue fixe Fixed wheel Ø 125 (5")	TPR-PP	Vrac / Bulk	1/1
MCH901861	Roue pivotante Swivelling wheel Ø 125 (5")	TPR-PP	Vrac / Bulk	1/1



PROFESSIONNEL 300 KG Professional 300 kg



Roues Ø 200 mm - Wheels 200 mm Ø
4 roues pneumatiques sur jante en acier - 4 pneumatic tyres on steel rims
Charge utile maximum : 300 kg - Loading capacity up to 300 kg
Dimensions plateforme : 900 x 605 mm - Platform size : 900 x 605 mm
6 crochets de fixation - 6 fixing hooks

REF.	DIM. (LXPXHMM)	CARACTÉRISTIQUES SPECIFICATIONS	CONDITIONNEMENT PACKING	UV/PCB
MCH501671	900 x 605 x 360 900 x 605 x 935	Acier-PVC Steel-PVC	Vrac / Bulk	1/1



MANUTENTION

Handling

CARGO 150 KG

Chariot pliable structure en tube d'acier - Tubular steel frame foldable platform trolley

Dossier de poussée rabattable par pression sur la barre horizontale (déverrouillage au pied) - Foldable backrest with foot pressure on the bottom bar

Plateforme acier embouti avec tapis PVC bleu antidérapant - Pressed steel platform with blue non-slipping PVC carpet

4 roues pleines bandage caoutchouc Ø 100 mm sur jantes plastiques avec cache métal - 4 rubber-tyred solid wheels 100 mm Ø on plastic rim with steel cover



Roues multidirectionnelles : 2 fixes & 2 pivotantes - Multidirectional wheels : 2 fixed & 2 swivelling

Charge utile maximum : 150 kg - Loading capacity up to 150 kg

Dimensions plateforme : 730 x 470 mm - Platform size : 730 x 470 mm

Pare-choc de protection TPR - TPR protection bumper



REF.	DIM. (LXPXHMM)	CARACTÉRISTIQUES SPECIFICATIONS	CONDITIONNEMENT PACKING	LIV/PCB
MCH500071	730 x 470 x 130 730 x 470 x 820	Acier-PVC Steel-PVC 	Vrac / Bulk	1/1
MCH902161	Roue fixe Fixed wheel Ø 100 (4")	Caoutchouc-PP Rubber-PP 	Vrac / Bulk	1/1
MCH902261	Roue pivotante Swivelling wheel Ø 100 (4")	Caoutchouc-PP Rubber-PP 	Vrac / Bulk	1/1

Chariot pliable

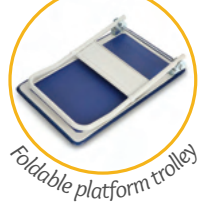

Foldable platform trolley

Barre de verrouillage



Locking bar

Tapis PVC antidérapant



Non-slipping PVC carpet

Roues fixes



Fixed wheels

Roues pivotantes



Swivelling wheels



CARGO 250 KG & 300 KG

Chariot pliable structure en tube d'acier - Tubular steel frame foldable platform trolley
 Dossier de poussée rabattable par pression sur la barre horizontale (déverrouillage au pied) - Foldable backrest with foot pressure on the bottom bar
 Plateforme acier embouti avec tapis PVC antidérapant - Pressed steel platform with non-slipping PVC carpet
 4 roues multidirectionnelles Ø 125 mm : 2 fixes & 2 pivotantes - 4 multidirectional wheels 125 mm Ø : 2 fixed & 2 swivelling
 Dimensions plateforme : 725 x 472 mm - Platform size : 730 x 470 mm
 Pare-choc de protection TPR - TPR protection bumper

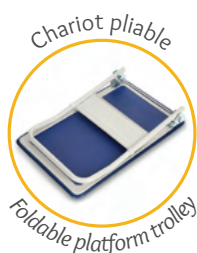

Roues PU sur jantes plastiques avec cache métal - PU wheels on plastic rims with steel covers

REF.	DIM. (LXPXHMM)	CARACTÉRISTIQUES SPECIFICATIONS	CONDITIONNEMENT PACKING	UV/PCB
MCH500971	725 x 472 x 260 725 x 472 x 850	Acier-PVC Steel-PVC	250 kg Vrac / Bulk	1/1
MCH500771	725 x 472 x 260 725 x 472 x 850	Acier-PVC Steel-PVC	300 kg Vrac / Bulk	1/1
MCH900771	Roue fixe Fixed wheel Ø 125 (5")	PU-PP	 Vrac / Bulk	1/1
MCH900871	Roue pivotante Swivelling wheel Ø 125 (5")	PU-PP	 Vrac / Bulk	1/1

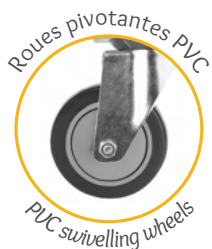

Roues PVC sur jantes plastiques - PVC wheels on plastic rims
 Roues silencieuses - Noiseless wheels

REF.	DIM. (LXPXHMM)	CARACTÉRISTIQUES SPECIFICATIONS	CONDITIONNEMENT PACKING	UV/PCB
MCH501071	725 x 472 x 260 725 x 472 x 850	Acier-PVC Steel-PVC	300 kg Vrac / Bulk	1/1
MCH900971	Roue fixe Fixed wheel Ø 125 (5")	PVC-PP	 Vrac / Bulk	1/1
MCH901071	Roue pivotante Swivelling wheel Ø 125 (5")	PVC-PP	 Vrac / Bulk	1/1

MANUTENTION

Handling

PLIABLE 137 KG

Foldable platform trolley 137 kg

Chariot pliable plateforme plastique et armature métal - Foldable trolley plastic platform and metal frame
4 roues pleines bandage TPR Ø 100 mm sur jante nylon - 4 TPR solid wheels 100 mm Ø on nylon rim
4 roues escamotables : 2 fixes & 2 pivotantes - 4 retractable wheels : 2 fixed & 2 swivelling
Plateforme antidérapante - Non-slip platform
Dimensions plateforme : 670 x 405 mm - Platform size : 670 x 405 mm
Charge utile maximum : 137 kg - Loading capacity up to 137 kg
Poignée télescopique aluminium revêtement grip antidérapant - Anti-slip grip aluminium telescopic handle
Hauteur 3 positions : 72, 82 & 92 mm - Height 3 positions : 72, 82 & 92 mm

REF.	DIM. (LXPXHMM)	CARACTÉRISTIQUES SPECIFICATIONS	CONDITIONNEMENT PACKING	UV/PCB
MCH400071	410 x 680 x 80 410 x 680 x 920	Aluminium-PP Aluminum-PP	 Vrac / Bulk	1/1



PLIANT 100 KG

Foldable platform trolley 100 kg

Chariot pliable structure aluminium - Aluminium foldable platform trolley
4 roues pleines bandage TPR Ø 100 mm sur jantes PP - 4 TPR solid wheels 100 mm Ø on PP rims
4 roues escamotables : 2 fixes & 2 pivotantes - 4 retractable wheels : 2 fixed & 2 swivelling
Dimensions plateforme : 500 x 415 mm - Platform size : 500 x 415 mm
Plateau extensible : 500 à 725 mm - Extendable platform : 500 to 725 mm
Charge utile maximum : 100 kg - Loading capacity up to 100 kg
Poignée télescopique acier chromé revêtement mousse - Soft-foam grip chrome steel telescopic handle



REF.	DIM. (LXPXHMM)	CARACTÉRISTIQUES SPECIFICATIONS	CONDITIONNEMENT PACKING	UV/PCB
MCH400171	410 x 500 x 230 420 x 710 x 950	Métal Metal	 Vrac / Bulk	1/1



400 KG

Standard platform trolley 400 kg

Chariot universel plateforme bois et structure en tube d'acier - Wooden platform and tubular steel frame platform trolley
4 roues pleines bandage caoutchouc Ø 150 mm sur jantes plastiques - 4 rubber-tyred solid wheels 150 mm Ø on plastic rims
4 roues multidirectionnelles : 2 fixes & 2 pivotantes - 4 multidirectional wheels : 2 fixed & 2 swivelling
Plateforme en bois - Wooden platform
Dimensions plateforme : 1140 x 550 mm - Platform size : 1140 x 550 mm
Charge utile maximum : 400 kg - Loading capacity up to 400 kg
Poignée fixe hauteur 780 mm - Fixed handle height 780 mm

REF.	DIM. (LXPXHMM)	CARACTÉRISTIQUES SPECIFICATIONS	CONDITIONNEMENT PACKING	UV/PCB
MCH100241	550 x 1140 x 780	Acier-Bois Steel-Wood	 Vrac / Bulk	1/1
MCH900361	Roue fixe Fixed wheel Ø 150 (6")	Caoutchouc-PP Rubber-PP	 Vrac / Bulk	1/1
MCH900461	Roue pivotante Swivelling wheel Ø 150 (6")	Caoutchouc-PP Rubber-PP	 Vrac / Bulk	1/1



CARGO 250 KG & 300 KG

Chariot double plateaux structure en tube d'acier embouti - Tubular steel frame double platform service trolley
2 poignées fixes - 2 fixed handles
Plateaux acier embouti avec tapis PVC bleu antidérapant - Pressed steel platforms with blue non-slipping PVC carpet
4 roues multidirectionnelles : 2 fixes & 2 pivotantes - 4 multidirectional wheels : 2 fixed & 2 swivelling
Pare-choc de protection TPR - TPR protection bumper

Roues PVC sur jantes plastiques - PVC wheels on plastic rims
Charge utile maximum : 250 kg - Loading capacity up to 250 kg
Hauteur entre plateaux : 530 mm - Height between platforms : 530 mm
822012 : poignées finition chromée - Chrome finish handles



REF.	DIM. (LXPXHMM)	CARACTÉRISTIQUES SPECIFICATIONS	CONDITIONNEMENT PACKING	UV/PCB	
822012*	730 x 470 x 990	Acier-PVC Steel-PVC	250 kg	Vrac / Bulk	1/1
MCH300071	725 x 472 x 910	Acier laqué-PVC Lacquered steel-PVC	250 kg	Vrac / Bulk	1/1
MCH901171	Roue fixe Fixed wheel Ø 100 (4")	PVC-PP		Vrac / Bulk	1/1
MCH901271	Roue pivotante Swivelling wheel Ø 100 (4")	PVC-PP		Vrac / Bulk	1/1

* Jusqu'à épaissement des stocks



Roues PU sur jantes plastiques avec cache métal - PU wheels on plastic rims with steel covers

Charge utile maximum : 300 kg - Loading capacity up to 300 kg
Hauteur entre plateaux : 500 mm - Height between platforms : 500 mm

REF.	DIM. (LXPXHMM)	CARACTÉRISTIQUES SPECIFICATIONS	CONDITIONNEMENT PACKING	UV/PCB	
MCH300171	907 x 608 x 870	Acier laqué-PVC Lacquered steel-PVC	300 kg	Vrac / Bulk	1/1
MCH900771	Roue fixe Fixed wheel Ø 125 (5")	PU-PP		Vrac / Bulk	1/1
MCH900871	Roue pivotante Swivelling wheel Ø 125 (5")	PU-PP		Vrac / Bulk	1/1



MANUTENTION

Handling

PLATEAUX DE TRANSPORT / PLATFORM CARTS



Carry handle



Swivelling wheels



PLATEAU BOIS 300 KG Wooden dolly 300 kg

Plateau bois contreplaqué épaisseur 18 mm - Plywood plate thickness 18 mm
 Roues pleines bandage caoutchouc Ø 100 mm sur jantes plastiques - 4 rubber-tyred solid wheels 100 mm Ø on plastic rims
 4 roues pivotantes - 4 swivelling wheels
 Charge utile maximum : 300 kg - Loading capacity up to 300 kg
 Dimensions plateau : 600 x 400 mm - Platform size : 600 x 400 mm
 4 patins caoutchouc antidérapants - 4 anti-slip rubber pads on the top
 Poignée de transport - Carry handle
 Pare-chocs de protection PP - PP protection bumpers

REF.	DIM. (HxLxPMM)	CARACTÉRISTIQUES SPECIFICATIONS	CONDITIONNEMENT PACKING	UV/PCB
MCH100041	600 x 400 x 150	Bois-PP Wood-PP	Vrac / Bulk	1/1
MCH900561	Roue pivotante Swivelling wheel Ø 100 (4")	Caoutchouc-PP Rubber-PP	Vrac / Bulk	1/1

PLATEAU PLASTIQUE 150 KG Plastic platform cart 150 kg

Plateau de transport modulaire structure plastique - Interconnecting plastic dolly
 Possibilité d'assembler les plateaux longitudinalement & latéralement pour une plus grande surface - Can be linked lengthways & sideways at the same time to make larger plarforms
 4 roues pivotantes montées sur roulement à billes Ø 80 mm - 4 swivelling NBR wheels 80 mm Ø
 Charge utile maximum : 150 kg - Loading capacity up to 150 kg
 Dimensions plateau : 485 x 380 mm - Platform size : 485 x 380 mm
 Épaisseur plateau : 30 mm - Platform thickness : 30 mm
 Poignées de transport - Carry handles

REF.	DIM. (HxLxPMM)	CARACTÉRISTIQUES SPECIFICATIONS	CONDITIONNEMENT PACKING	UV/PCB
3790*	485 x 380 x 90	PP	Vrac / Bulk	1/1

* Jusqu'à épaisseur des stocks



TRANSPALETTE / HAND PALLET TRUCK



TRANSPALETTE MANUEL PRO Professional hand pallet truck

Transpalette manuel châssis tôle 3 mm - Steel frame 3 mm pallet hand truck
 Pompe hydraulique en acier avec valve de sécurité en cas de surcharge - Hydraulic steel pump with safety valve in case of overload
 Timon 3 positions rotation 200° : levée / neutre / descente - 3 positions drawbar rotation 200° : lift / neutral / descent
 Roues directrices caoutchouc Ø 200 mm et boggies PU avec double galet à l'entrée - Rubber steering wheels 200 mm Ø and PU boggies with dual roller in front
 Roulements étanches - Sealed bearings
 Hauteur d'élévation : 200 mm - Lift height: 200 mm
 Hauteur fourches abaissées : 85 mm - Lowered fork height: 85 mm
 Largeur extérieure : 540 mm - External width: 540 mm
 Fourche : l.1150 x L.160 x H.60 mm - Fork : l.1150 x L.540 x H.60 mm
 Charge utile maximum : 2500 kg - Loading capacity up to 2500 kg
 Conforme à la directive 2006/42/CE - Comply with 2006/42/EC directive

REF.	DIM. (HXLXPM)	CARACTÉRISTIQUES SPECIFICATIONS	CONDITIONNEMENT PACKING	UV/PCB
MTLI00171	-	-	Vrac / Bulk	1/1

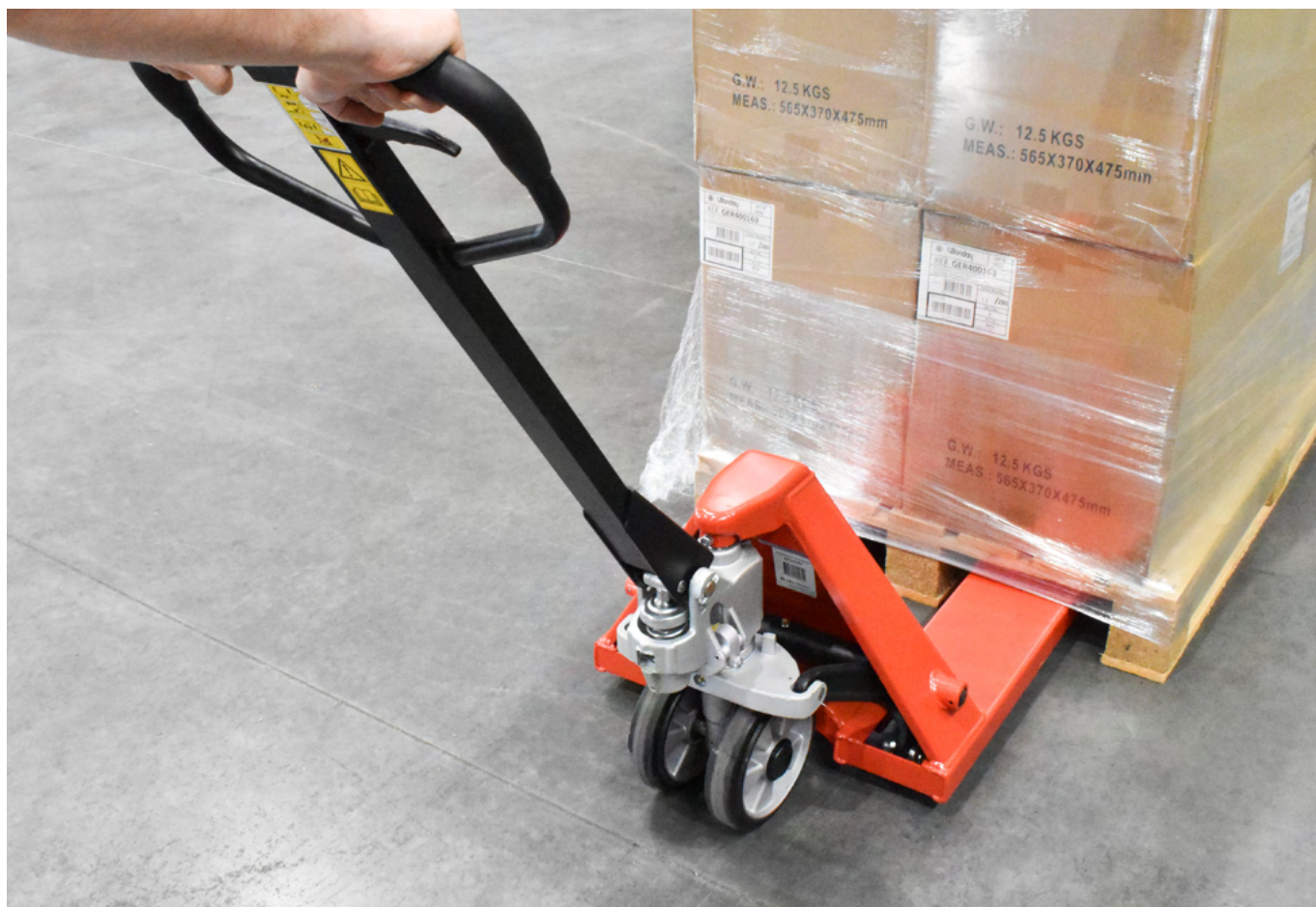

LA SÉCURITÉ ENTRE VOS MAINS



Wonday en profite pour vous présenter sa grande soeur Reskal.

Dans la famille **Sécurité des Personnes et des Biens**, cette marque est spécialiste de nombreux produits tels que des coffres-forts, caisses à monnaie, compteuses de pièces ou détecteurs de faux billets, etc. Complices et soudées, ces deux marques complémentaires grandissent ensemble pour le plus grand bonheur de leurs clients.

Assurez la protection des personnes et sécurisez vos biens... Équipez-vous !

Que ce soit pour mettre à l'abri vos documents confidentiels ou vos produits de valeurs, ou pour prévenir d'un risque éventuel, Reskal, la marque fière d'être distribuée par Wonday, dispose d'une gamme de produits correspondant à vos besoins ou attentes.

Vous y trouverez votre compte !

Une mise en marche ? Une réparation ? Un entretien ? Notre service après-vente vous répond :

- **Par mail :**
sav@reskal.com / sav@wonday.com
- **Par téléphone :**
+33 (0)4 73 51 78 20 / +33 (0)4 73 51 78 15
- **Horaires :**
du lundi au jeudi de 8h à 12h30 et de 13h15 à 18h
et le vendredi de 8h à 12h30 et de 13h15 à 16h30

Merci de nous informer d'un retour de marchandises au préalable par téléphone ou mail.



reskal.com



LEXIQUE

Glossary

PICTOGRAMMES / PICTOGRAM

Unité de vente - Boîte carton <i>Minimum quantity - Outer box</i>	UV/PCB	Litrage (L) <i>Capacity (L)</i>	
Coloris <i>Color</i>		Nombre de pènes <i>Number of locking bolts</i>	
Serrure à clé <i>Key lock</i>		Nombre d'étagère <i>Number of shelf</i>	
Serrure électronique <i>Electronic lock</i>		Nombre de tiroir <i>Number of drawer</i>	
Empreinte digitale <i>Fingerprint</i>		Clé de secours <i>Emergency key</i>	
Combinaison mécanique <i>Mechanical lock</i>		Signal sonore <i>Audio alert (beep)</i>	
Bouton poussoir <i>Push button</i>		Eclairage intérieur <i>Indoor lighting</i>	
Serrure à combinaison <i>Combination lock</i>		Nombre de piles & type <i>Number of batteries & type</i>	
Bouton poussoir magnétique <i>Magnetic pushing button</i>		Fixation sol & mur <i>Floor & wall mounting</i>	
Aimanté <i>Magnetic</i>		Fixation sol ou mur <i>Floor or wall mounting</i>	
Nombre de compartiments <i>Number of compartments</i>		Boitier de piles externe <i>External battery box</i>	
Ignifuge 1H papier <i>1H Fireproof paper</i>		Fabrication européenne <i>Made in Europe</i>	
Ignifuge 2H papier <i>2H Fireproof paper</i>		Fabrication française <i>Made in France</i>	
Hydrofuge <i>Waterproof</i>		Porte-clés inclus <i>Key rings supplied</i>	

MATIÈRES / MATERIAL

Acrylonitrile Butadiène Styène	ABS	Éthylène-acétate de vinyle	EVA
Polypropylène	PP	Polyéthylène	PE
Polystyrène	PS	Polyéthylène basse densité	PEBD / PELD
Polychlorure de vinyle	PVC	Polyamide	PA
Polytéréphtalate d'éthylène	PET	Polycarbonate	PC

DÉTECTION / DETECTION

InfraRouge <i>InfraRed</i>	IR	Taille <i>Size</i>	SIZE
UltraViolet <i>UltraViolet</i>	LIV	Euro	€
Magnétique <i>Magnetic</i>	MG	Livre britannique	GBP £
Fil de sécurité Métallique <i>Metal Thread</i>	MT	Dollar américain	US \$
Filigrane <i>Watermark</i>	WM	Franc suisse	CHF

SÉCURITÉ

Safety

Une sélection qui vous va comme un gant ! Adoptez les équipements incontournables pour garantir votre sécurité au travail. La sécurité au travail constitue une obligation de résultat pour l'employeur. Il est tenu de prendre toutes les mesures nécessaires afin d'assurer la sécurité et de protéger la santé physique et mentale de ses collaborateurs (article L.4121- et L4121-2 du code du travail). À travers cette sélection, nous sommes convaincus que vous trouverez chaussures à vos pieds... Alors jetez un coup œil et sortez couverts !



TROUSSE DE SECOURS / FIRST AID KITS



Bulletin officiel de l'Éducation Nationale Hors Série n°1 du 6 janvier 2000

Extrait : « Toutes les écoles et établissements doivent avoir constitué une trousse de 1^{ers} secours qu'il convient d'emporter en cas de déplacement à l'extérieur. Elle doit comporter au minimum : les consignes sur la conduite à tenir en cas d'urgence, un antiseptique, des compresses, des pansements, bandes, écharpes, ciseaux»

TROUSSE DE SECOURS ÉCOLE (SORTIES SCOLAIRES, CENTRES AÉRÉS)



2/4 personnes
Fermeture par zip
Accroche ceinture par sangle
Multipoches de rangement
Trousse en EVA fluorescent
Croix rétro-réfléchissant

- 1 couverture de survie
- 1 écharpe triangulaire
- 10 pansements adhésifs 20 mm x 72 mm
- 4 pansements adhésifs 53 mm x 70 mm
- 1 pansement adhésif 10 cm x 6 cm
- 1 sachet de 5 compresses stériles 7,5 cm x 7,5 cm
- 2 bandes extensibles 3 m x 5 cm
- 1 rouleau de sparadrap sécable 5 m x 2 cm
- 1 paire de ciseaux 10 cm à bouts ronds
- 1 pince à écharde à mors plats
- 1 paire de gants jetables
- 5 compresses nettoyantes à la chlorhexidine
- 3 compresses anti coups au calendula
- 3 sachets de gel décontaminant mains sans eau
- 3 dosettes de sérum physiologique stérile
- 1 livret premiers soins en 10 langues

REF.	DIM.	CARACTÉRISTIQUES/SPECIFICATIONS	POIDS/WEIGHT	CONDITIONNEMENT/PACKING	LIV/PCB
IM50511	215 x 135 x 60 mm	EVA   	380 g	Vrac / Bulk	1/1



POCHETTE DE SECOURS UNIVERSELLE



5/10 personnes
Fermeture par zip refermable
Muni du trou européen
Pochette en 100 % PE
Emballage 100 % recyclable

- 1 couverture de survie
- 20 pansements adhésifs 20 mm x 72 mm
- 4 pansements adhésifs 53 mm x 70 mm
- 2 pansements adhésifs 10 cm x 6 cm
- 2 pansements compressifs stériles
- 2 sachets de 5 compresses stériles 7,5 cm x 7,5 cm
- 1 bande extensible de 3 m x 5 cm
- 2 bandes extensibles de 3 m x 7 cm
- 1 rouleau de sparadrap sécable 5 m x 2 cm
- 1 paire de ciseaux 13 cm à bouts ronds
- 1 pince à écharde à mors plats
- 1 paire de gants jetables
- 10 lingettes imprégnées d'une solution nettoyante cutanée à la chlorhexidine
- 2 trios de 0.8 ml de gel à l'arnica
- 5 lingettes imprégnées d'une solution hydroalcoolique
- 5 sachets de 5 ml d'eau gélifiée
- 5 dosettes de sérum physiologique stérile 5 ml
- 1 livret premiers soins en 10 langues

REF.	DIM.	CARACTÉRISTIQUES/SPECIFICATIONS	POIDS/WEIGHT	CONDITIONNEMENT/PACKING	LIV/PCB
IM50502	190 x 280 mm	PE   	330 g	Vrac / Bulk	1/20

Distribution France (DROM-COM inclus) uniquement
Retail France (including DROM-COM) only



MALLETE DE PREMIERE URGENCE PPMS (PLAN PARTICULIER DE MISE EN SÛRETÉ)



20/30 personnes
Polypropylène bleu
Poignée de transport et support mural

Documents :

- Tableau d'effectifs vierge (Annexe 8)
- Fiche « conduites à tenir en première urgence » (Annexe 10)
- Fiche individuelle d'observation (Annexe 9)

Matériels :

- 1 brassard
- 1 radio à piles
- 1 ruban adhésif
- 1 rouleau d'essuie-tout
- 1 lampe de poche avec piles
- 20 gobelets jetables
- 2 sacs poubelles
- 1 jeu de cartes
- 1 stylo
- 1 carnet

Mallette de première Urgence :

- 1 couverture de survie
- 1 écharpe triangulaire
- 1 thermomètre frontal
- 20 pansements adhésifs 20 mm x 72 mm
- 10 pansements adhésifs 53 mm x 70 mm
- 5 pansements adhésifs 10 cm x 6 cm
- 2 pansements compressifs stériles
- 10 compresses stériles individuelles 20 x 20 cm
- 10 compresses stériles individuelles 30 x 30 cm
- 2 bandes extensibles de 3 m x 5 cm
- 2 bandes extensibles de 3 m x 7 cm
- 2 bandes extensibles de 3 m x 10 cm
- 1 rouleau de sparadrap séccable 5 m x 2 cm
- 1 paire de ciseaux 13 cm à bouts ronds
- 1 pince à écharde à mors plats
- 5 paires de gants jetables
- 2 masques de protection type « masques chirurgicaux »
- 1 pulvérisateur de 50 ml de solution nettoyante à la chlorhexidine
- 1 flacon de 200 ml de solution hydroalcoolique
- 10 dosettes de sérum physiologique stérile
- 1 m de filet tubulaire pour doigts
- 1 m de filet tubulaire pour poignet ou cheville
- 10 morceaux de sucre emballés
- 1 paquet de 10 mouchoirs jetables
- 3 garnitures périodiques
- 1 pack de froid instantané
- 2 sacs en plastique
- 1 livret 1er soins en 10 langues.

Bulletin officiel du Ministère de l'Éducation Nationale N° 44 du 26/11/2015 – Circulaire N°2015 -205 du 25/11/2015

REF.	DIM.	CARACTÉRISTIQUES/SPECIFICATIONS	POIDS/WEIGHT	CONDITIONNEMENT/PACKING	LIV/PCB
IM50506	435 x 340 x 110 mm	-	2.8 Kg	Vrac / Bulk	1/1

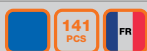

Distribution France (DROM-COM inclus) uniquement
Retail France (including DROM-COM) only



VALISE DE SECOURS MULTIRISQUES



4 personnes
Polypropylène blanc
Poignée de transport

- 10 pansements adhésifs 20 mm x 72 mm
- 2 pansements adhésifs 53 mm x 70 mm
- 1 pansement compressif stérile
- 4 compresses stériles individuelles 20 cm x 20 cm
- 1 bande extensible de 3 m x 5 cm
- 1 rouleau de sparadrap sécable 5 m x 2 cm
- 1 paire de ciseaux 10 cm à bouts ronds
- 1 pince à échardes à mors plats
- 1 paire de gants jetables
- 5 compresses nettoyantes à la chlorhexidine
- 3 compresses anti coups au calendula
- 2 dosettes de sérum physiologique stérile
- 1 livret premiers soins en 10 langues

REF.	DIM.	CARACTÉRISTIQUES/SPECIFICATIONS	POIDS/WEIGHT	CONDITIONNEMENT/PACKING	LIV/PCB
IM50505	240 x 205 x 48 mm	33 PCS	300 g	Vrac / Bulk	1/1

KIT DE RÉASSORT POUR ARMOIRE À PHARMACIE



5/10 personnes



- 1 couverture de survie
- 37 pansements adhésifs assortis :
 - 20 de 20 mm x 72 mm
 - 8 de 53 mm x 70 mm
 - 9 de 10 cm x 6 cm
- 2 pansements compressifs stériles
- 20 compresses stériles individuelles 20 cm x 20 cm
- 2 bandes extensibles 3 m x 5 cm
- 2 bandes extensibles 3 m x 10 cm
- 1 rouleau de sparadrap sécable 5 m x 2 cm
- 1 paire de ciseaux 13 cm à bouts ronds
- 1 pince à échardes à mors plats
- 2 paires de gants jetables
- 6 compresses nettoyantes à la chlorhexidine
- 6 compresses d'alcool à 70°
- 6 compresses anti coups au calendula
- 6 compresses de lotion asséchante
- 1 aérosol de froid 270 ml
- 1 lot de 2 tampons hémostatiques pour le nez
- 2 dosettes de sérum physiologique stérile
- 1 livret premiers soins en 10 langues

REF.	DIM.	CARACTÉRISTIQUES/SPECIFICATIONS	POIDS/WEIGHT	CONDITIONNEMENT/PACKING	LIV/PCB
IM50010	250 x 150 x 70 mm	98 PCS	500 g	Boîte / Box	1/1

SECOURIR - PRÉVENIR

Rescue - Prevent

ARMOIRES À PHARMACIE / MEDICINE CABINETS



ARMOIRES À PHARMACIE Medicine cabinets

Corps métal (acier plié & soudé) - Metal frame (bent & welded steel)
Ouverture/fermeture par serrure à clé (2 clés fournies) - Opening/closing by key lock (2 keys supplied)
Fixation mur (visserie fournie) - Wall mounting (hardware supplied)
Livrées vides - Delivered empty

REF.	DIM.	CARACTÉRISTIQUES/SPECIFICATIONS	ACCESSOIRES/Accessories	CONDITIONNEMENT/PACKING	LIV/PCB
IM50001	400 x 300 x 120 mm	Métal / Metal 		Boîte / Box	1/4
IM50002	450 x 350 x 130 mm	Métal / Metal 		Boîte / Box	1/4



ARMOIRES À PHARMACIE PREMIUM Premium medicine cabinets

Corps métal (acier plié & soudé) - Metal frame (bent & welded steel)
Ouverture/fermeture :
- IM50003 : par serrure à clé (2 clés fournies) & bouton-poussoir magnétique
- IM50004 : bouton-poussoir magnétique
Opening/closing :
- IM50003 : by key lock (2 keys supplied) & magnetic pushing button
- IM50004 : by magnetic pushing button
Porte aimantée en verre trempé - Magnet tempered glass door
Fixation mur (visserie fournie) - Wall mounting (hardware supplied)
Livrées vides - Delivered empty

REF.	DIM. / POIDS	CARACTÉRISTIQUES/SPECIFICATIONS	ACCESSOIRES/Accessories	CONDITIONNEMENT/PACKING	LIV/PCB
IM50003	600 x 300 x 120 mm 4,28 kg	Métal / Metal Verre / Glass 		Boîte / Box	1/2
IM50004	300 x 300 x 120 mm 2,15 kg	Métal / Metal Verre / Glass 		Boîte / Box	1/4

COFFRET DE SECOURS, REGISTRE DE SÉCURITÉ & EXTINCTEURS EMERGENCY BOX, SECURITY REGISTER & EXTINGUISHERS



COFFRET DE SECOURS AVEC MARTEAU BRISE-VITRE Emergency box with hammer breaking glass

Corps métal (acier ambouti) - Metal frame (pressed steel)
Suspension fixe 3 crochets - 3 fixed suspensions
Ouverture/fermeture par serrure à clé (2 clés fournies) - Opening/closing by key lock (2 keys supplied)
Dimension de la vitre : 107 x 77 mm - Glass size : 107 x 77 mm
Épaisseur de la vitre : 2 mm - Glass thickness : 2 mm
Marteau brise-vitre retenu par un chaînette inox insérée dans le boîtier
Pointed hammer hold by stainless steel chain inside box
27802 : vitre de sécurité - 27802 : safety glass

REF.	DIM.(MM)	CARACTÉRISTIQUES SPECIFICATIONS	CONDITIONNEMENT PACKING	LIV/PCB
27801	160 x 120 x 65	Métal / Metal   	Vrac / Bulk	1/6
27802	75 x 105	Verre / Glass 	Vrac / Bulk	1/1



EXTINCTEUR ABC 1KG

Extincteur poudre 1 kg ABC à pression permanente
Corps en tôle d'acier
Manomètre de contrôle pour une lecture claire & simple de la pression de service
Robinetterie entièrement en laiton
Support de transport

Agent extincteur : poudre ABC 1 kg
Agent propulseur : azote à 20°C sous pression 15 bar
Durée de fonctionnement : 7,13 s
Certification : NF EN-3/EP2 045 730

REF.	DIM.(MM)	CARACTÉRISTIQUES SPECIFICATIONS	CONDITIONNEMENT PACKING	LIV/PCB
13.7164	Ø 85 x 330	Acier / Steel 	Boîte / Box	1/1

REGISTRE DE SÉCURITÉ (ERP, HABITATION & INDUSTRIE)

Format A4, 55 pages
Contient un rappel des réglementations principales en vigueur à l'intérieur des locaux

REF.	DIM.(MM)	CARACTÉRISTIQUES SPECIFICATIONS	CONDITIONNEMENT PACKING	LIV/PCB
N-REG-U100	A4 (210x297)	Papier / Paper 	Vrac / Bulk	1/20



EXTINCTEUR ABC 6KG

Extincteur poudre 6 kg ABC
Corps en tôle d'acier
Manomètre de contrôle pour une lecture claire & simple de la pression de service
Poignée ergonomique & robinetterie chromée
Attache aimantée
Embout/tuyau de propulsion

Agent extincteur : poudre ABC 6 kg
Agent propulseur : azote à 20°C sous pression 15 bar
Durée de fonctionnement : 23,7 s
Certification : NF EN-3/EP6 045 569

REF.	DIM.(MM)	CARACTÉRISTIQUES SPECIFICATIONS	CONDITIONNEMENT PACKING	LIV/PCB
13.7442*	Ø 160 x 545	Acier / Steel 	Boîte / Box	1/1

* Jusqu'à épuisement des stocks

SIGNALISATION / SIGNALISATION



CHEVALETS DE SIGNALISATION PLIANT Folding caution signs

Modèle « Attention » - Models « Attention »

REF.	DIM.	POIDS WEIGHT	CARACTÉRISTIQUES SPECIFICATIONS	CONDITIONNEMENT PACKING	LUV/PCB
SPV100161*	610 x 280 x 30	600 g	PP 	Boîte / Box	1/10

* Jusqu'à épuisement des stocks





CÔNES DE SIGNALISATION RÉTRACTABLE Collapsible traffic cones

Fluorescent & rétro réfléchissant - Fluorescent & retroreflective

Usage diurne et nocturne - Day and night use

Textile résistant à l'eau - Water-resistant fabric

Base lestée sur modèles moyens & grands - Weighted base on big & medium models

REF.	DIM.	POIDS WEIGHT	CARACTÉRISTIQUES SPECIFICATIONS	CONDITIONNEMENT PACKING	LUV/PCB
SPV010021	320 x 190 x 90 mm	300 g	Textile / Caoutchouc Fabric / Rubber 	LS / Pegbordable	1/20
SPV010121	450 x 250 x 250 mm	2 kg	Textile / Caoutchouc Fabric / Rubber 	Boîte / Box	1/10
SPV010221	720 x 380 x 380 mm	3.6 kg	Textile / Caoutchouc Fabric / Rubber 	Boîte / Box	1/5

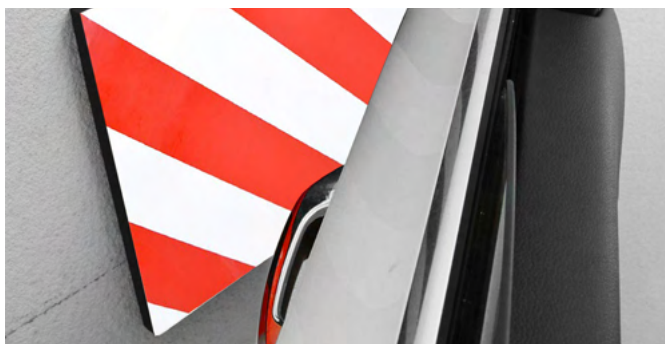

BANDES DE PROTECTION MURALE Wall protectionstrips

Matériau léger, souple, résistant & étanche - Lightweight, flexible, resistant & waterproof material

Mousse adhésive pour signaler et protéger des zones dangereuses en intérieur et extérieur - Adhesive foam to indicate and protect hazardous areas indoors and outdoors

Pour le scolaire : sécurisation des terrains de jeux, gymnase, etc - For schools : securing playgrounds, gymnasiums, etc

Pour le bureau : sécurisation des ateliers, parkings, etc - For the office : securing workshop, car parks, etc



REF.	DIM.	CARACTÉRISTIQUES/SPECIFICATIONS	POIDS/WEIGHT	CONDITIONNEMENT/PACKING	LUV/PCB
SPV200261	500 x 100 x 15	NBR 	65 g	Boîte / Box	1/160
SPV200361	240 x 180 x 40	NBR 	125 g	Boîte / Box	1/78





PROTECTIONS D'ANGLE Angle protections

Matériau léger, souple, résistant & étanche - *Lightweight, flexible, resistant & waterproof material*

Mousse adhésive pour signaler et protéger des zones dangereuses en intérieur et extérieur - *Adhesive foam to indicate and protect hazardous areas indoors and outdoors*

Pour le scolaire : sécurisation des terrains de jeux, gymnase, etc - *For schools : securing playgrounds, gymnasiums, etc*

Pour le bureau : sécurisation des ateliers, parkings, etc - *For the office : securing workshop, car parks, etc*

REF.	DIM.	CARACTÉRISTIQUES/SPECIFICATIONS	POIDS/WEIGHT	CONDITIONNEMENT/PACKING	LIV/PCB
SPV200061	500 x 250 x 20	NBR 	195 g	LS / Pegboardable	1/50
SPV200161	500 x 250 x 20	NBR 	180 g	Boîte / Box	1/50

ÉQUIPEMENTS DE PROTECTION INDIVIDUELLE / INDIVIDUAL PROTECTIVE EQUIPMENT



bollé
SAFETY



BL30

Protection supérieure - *Superior protection*

Légère et sans vis - *Light and without screws*

Système d'arrêt des branches - *Branches stop-in system*

Pour tous les visages - *For all faces*

REF.	COLORIS/COLOUR	TRAITEMENT/PROCESSING	LIV/PCB
PSSBL30-014		Anti-rayures - Anti-buée sur les deux faces <i>Scratch-resistant - Antifog on both sides</i>	20/240



OVERLIGHT

Surlunettes : port de lunettes correctrices possible - *Over-glasses : wearing corrective glasses is possible*

Design ergonomique - *Ergonomic design*

Monture ultra-enveloppante - *Ultra enveloping frame*

Protection latérale, supérieure et inférieure - *Upper and lower lateral protection*

REF.	COLORIS/COLOUR	TRAITEMENT/PROCESSING	LIV/PCB
OVLITLPSI		Anti-rayures-Anti-buée <i>Scratch-resistant-Antifog</i>	10/240

COMMENT CHOISIR SON COFFRE-FORT EN 5 POINTS

1. Quel modèle choisir ?

Tout dépend du degré de sécurité, du système de fermeture, du caractère ignifuge, de la classe de valeur assurable et des éventuelles options que vous choisirez :

- Pour un modèle à poser : optez pour un coffre-fort de 5 à 50L.
- Pour un modèle à encastrer : optez pour le même litrage, l'option encastrable vous assurant une meilleure protection contre le vol.

2. Ce que je souhaite protéger !

- Documents : papiers administratifs, état civil, contrats d'assurance, papiers bancaires, etc.
- Support de données : sauvegarde informatique, disque dur, clé USB, etc.
- Objets de valeur : bijoux, argent, etc.



3. Quel volume utile ?

- 10-20L : faible volume et format compact, facilement dissimulable (bijoux, cartes, papiers administratifs, etc).
- 20-40L : volume intermédiaire (équipements informatiques, etc).
- 40-60L : grands volumes (classeurs, archives, etc).
- + de 60L : très grands volumes (armes, etc).

4. Quel mode d'ouverture ?

- À clé : plus économique et simple d'utilisation (limite : gestion des clés).
- À digicode (avec clés de secours) : système fiable sans besoin de clé.
- À empreinte digitale.
- À carte magnétique (tous types) : adaptée pour une gamme spécifique hôtel.

5. Quel type de protection ?

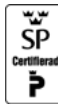
- Feu
 - Pour les coffres ignifuges 1h pour les papiers, la norme « UL 72 class 350 » (Underwriters Laboratories INC – laboratoire américain) est obligatoire. Le coffre peut être chauffé à 927°C pendant 1h sans que la température intérieure ne dépasse 177°C, valeur maximale pour que le papier ne brûle pas. 
 - Certains coffres ignifuges ont la norme SP 1h papier. 
 - Pour les coffres ignifuges 2h, la norme « SP » (The Swedish national testing & research institute : laboratoire suédois) est obligatoire. 
 - Pour les papiers : NT Fire 017-120 Paper. Le coffre peut être chauffé à 1090°C pendant 2h sans que la température intérieure ne dépasse 150°C.
- Effraction : coffre de sécurité
- Feu & effraction : coffre à valeur assurable.

NORMES	EN 14450		EN 1143-1						
	S1	S2	0 E	I E	II E	III E	IV E	V E	VI E
Montant assurable en France (K€)*	1,5	3	8	25	35	55	110	200	300

QUELQUES EXPLICATIONS SUR LES DIMENSIONS

Dimensions extérieures

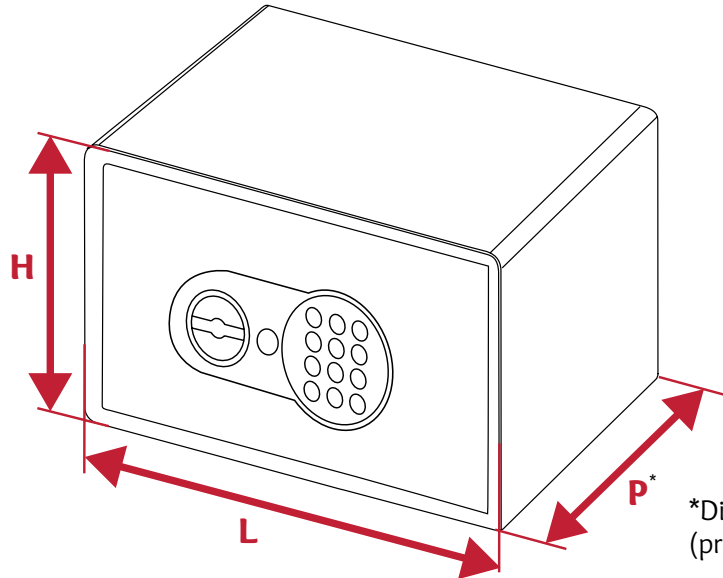

*Dimension hors tout
(profondeur totale encastrable)

Dimensions intérieures volumétriques

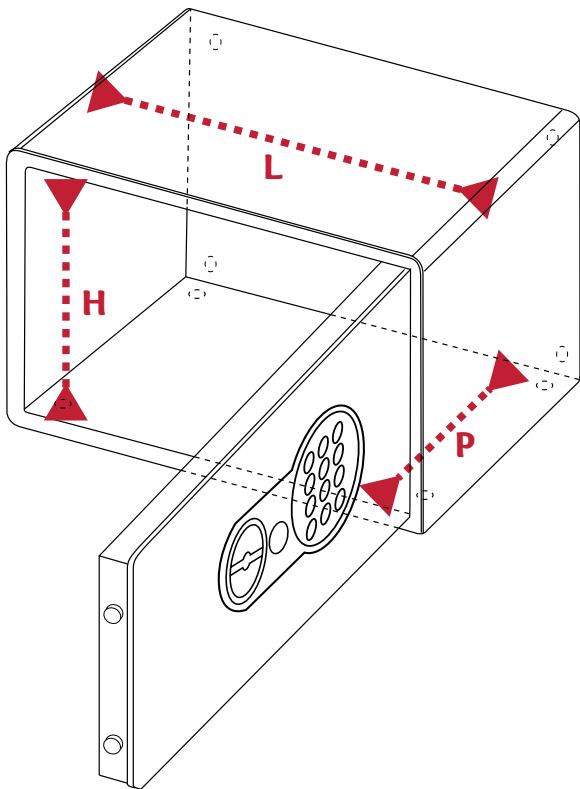

Dimensions intérieures de passage

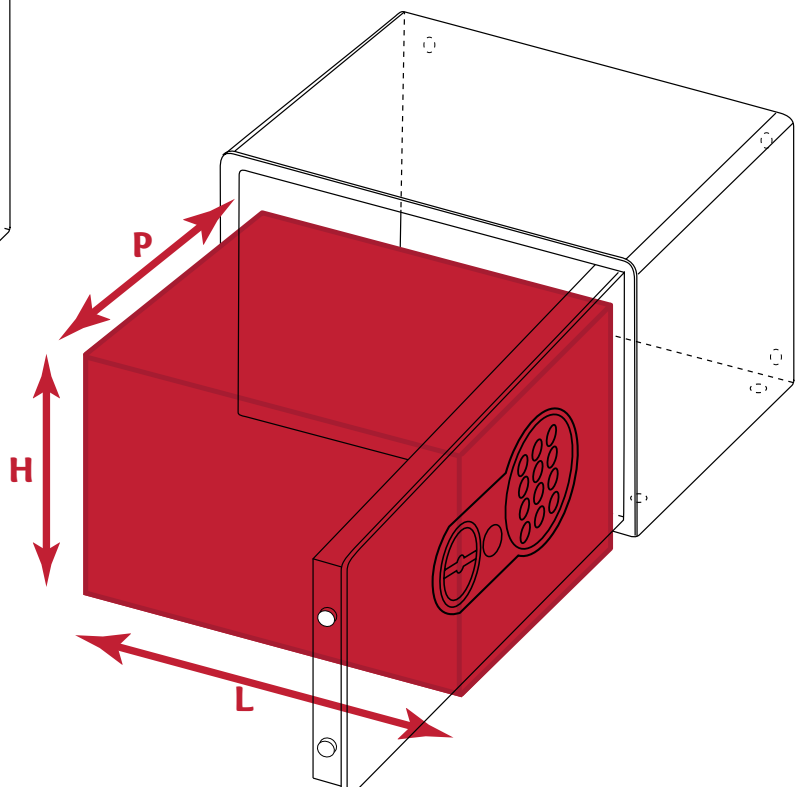

COFFRES DE SÉCURITÉ / SECURITY SAFES



COFFRES DE SÉCURITÉ Security safes

Acier monobloc - Monobloc steel frame

Ø pènes : 20 mm - Bolts Ø : 20 mm

Verrouillage :

- SM1 : par serrure à clé (2 clés fournies)
- SE2, SE3 & SE4 : par serrure électronique & bouton pousier

Locking:

- SM1: Opening/closing by key lock (2 keys supplied)
- SE2, SE3 & SE4 : by electronic lock & thumbturn

1 code utilisateur (combinaison numérique de 3 à 8 chiffres) - 1 user code (combination of 3 to 8 digits)

Serrure d'urgence dissimulée - Hidden emergency lock

Angle d'ouverture de la porte : 90° max. - Door opening angle : 90° max.



FA62340



FA62342



FA62344



FA62339

REF.	DIM. EXT. - DIM. INT. (H X L X P MM)	DIM. INT. DE PASSAGE (H X L X P MM)	CARACTÉRISTIQUES SPECIFICATIONS	PORTE/PAROIS DOOR/ WALLS (MM)	KG	ACCESSOIRES ACCESSORIES	UV/PCB
FA62340	200 x 310 x 200 196 x 306 x 150	132 x 225 x 150		3/1.5	4,5		1/1
FA62342	250 x 350 x 250 246 x 346 x 180	180 x 235 x 180		4/2	6		1/1
FA62344	310 x 430 x 350 306 x 426 x 290	245 x 350 x 290		4/2	15,5		1/1
FA62339	607 x 390 x 410 603 x 386 x 350	554 x 285 x 350		4/2	27		1/1



COFFRES DE SÉCURITÉ «GROS VOLUME» Security safes «High capacity»

Acier monobloc - Monobloc steel frame

Ø pènes : 25 mm - Bolts Ø : 25 mm

Ouverture/fermeture par serrure électronique - Opening/closing by electronic lock
Verrouillage par tringlerie 3 axes / 5 ou 6 points - 3-way combo locking bolts / 5 or 6 points

1 code utilisateur (combinaison numérique de 3 à 8 chiffres) - 1 user code (combination of 3 to 8 digits)

Poignée étoile métallique - Metallic 3-spoke handle

Système de débrayage de la poignée anti-effraction - Anti-burglary handle removal system

Serrure d'urgence dissimulée - Hidden emergency lock

Angle d'ouverture de la porte : 135° max. - Door opening angle : 135° max.



FA62305



FA62304

REF.	DIM. EXT. - DIM. INT. (H X L X P MM)	DIM. INT. DE PASSAGE (H X L X P MM)	CARACTÉRISTIQUES SPECIFICATIONS	PORTE/PAROIS DOOR/ WALLS (MM)	KG	ACCESSOIRES ACCESSORIES	UV/PCB
FA62304	704 x 550 x 500 698 x 544 x 425	590 x 410 x 425	147L	6/3	73,6		1/1
FA62305	960 x 550 x 500 954 x 544 x 425	845 x 410 x 425	200L	6/3	85,1		1/1

SÉCURISER - DÉTECTER

Secure - Detect



COFFRE DE SÉCURITÉ Security safes

Acier monobloc - Monobloc steel frame

Ø pènes : 20 mm - Bolts Ø: 20 mm

Déverrouillage par empreinte digitale ou serrure électronique - Unlocking by fingerprint or electronic lock

Système de mémorisation d'empreintes digitales (20 max.) - Fingerprint identification storage system (20 max.)

1 code utilisateur (combinaison numérique de 4 à 8 chiffres) - 1 user code (combination of 4 to 8 digits)

Serrure d'urgence dissimulée - Hidden emergency lock

Fiche pour boîtier de piles externe (boîtier non inclus) - External battery box plug (box not included)

Angle d'ouverture de la porte : 90° max. - Door opening angle : 90° max.



REF.	DIM. EXT. - DIM. INT. (H X L X P MM)	DIM. INT. DE PASSAGE (H X L X P MM)	CARACTÉRISTIQUES SPECIFICATIONS	PORTE/PAROIS DOOR/ WALLS (MM)	KG	ACCESSOIRES ACCESSORIES	UV/PCB
FA62530	250 x 350 x 250 246 x 346 x 185	180 x 245 x 185		4/2	8,59		1/1
SAV1102 Boîtier de piles externe External battery box	-	-		-	-	-	1/1

COFFRES DE SÉCURITÉ

Security safes



Acier monobloc - Monobloc steel frame

Peinture haute qualité (résistance accrue à la corrosion) - High-quality paint (Improved corrosion resistance)

Ø pènes : 20 mm - Bolts Ø : 20 mm

Verrouillage :

- SM1 Premium : par serrure à clé (2 clés fournies)

- SE, SE2, SE3, SE4 Premium : par serrure électronique & poignée

Locking:

- SM1 Premium : by key lock (2 keys supplied)

- SE, SE2, SE3 & SE4 Premium : by unique electronic lock & handle

Poignée sécurisée avec système anti-effraction - Safety handle with anti-burglary system

1 code utilisateur (combinaison numérique de 3 à 8 chiffres) - 1 user code (combination of 3 to 8 digits)

Serrure d'urgence dissimulée - Hidden emergency lock

Angle d'ouverture de la porte : 90° max. - Door opening angle : 90° max.

Système d'éclairage intérieur par LED (x 2 Ø5 mm) - Inner LED lighting system (x 2 5 mm Ø)

Affichage écran LCD - LCD display screen

Fiche pour boîtier de piles externe - External battery box plug

Vendu avec un boîtier de piles externe (modèles SE2, SE3 et SE4) - Supplied with an external battery box (SE2, SE3 and SE4 models)



FA62341



FA62740



FA62742



FA62744



FA62739

REF.	DIM. EXT. - DIM. INT. (H X L X P MM)	DIM. INT. DE PASSAGE (H X L X P MM)	CARACTÉRISTIQUES SPECIFICATIONS	PORTE/PAROIS DOOR/WALLS (MM)	KG	ACCESSOIRES ACCESSORIES	UV/PCB
FA62341	170 x 230 x 180 166 x 226 x 120	124 x 140 x 120		3/1,5	3,5		1/1
FA62740	200 x 310 x 200 196 x 306 x 160	135 x 235 x 160		3/2	4,3		1/1
FA62742	250 x 350 x 270 246 x 346 x 195	185 x 275 x 195		3/2	6,75		1/1
FA62744	310 x 430 x 375 306 x 426 x 290	245 x 350 x 290		4/2	15,8		1/1
FA62739	607 x 390 x 445 601 x 386 x 335	545 x 320 x 335		4/2	27,8		1/1

SÉCURISER - DÉTECTER

Secure - Detect



COFFRES DE DÉPÔT

Deposit safe

Acier monobloc - Monobloc steel frame
 Peinture haute qualité (résistance accrue à la corrosion) - High-quality paint (Improved corrosion resistance)
 Ø pènes : 20 mm - Bolts Ø : 20 mm
 Ouverture/fermeture par serrure électronique unique et poignée - Opening/closing by unique electronic lock and handle
 Poignée sécurisée avec système anti-effraction - Safety handle with anti-burglary system
 1 code utilisateur (combinaison numérique de 3 à 8 chiffres) - 1 user code (combination of 3 to 8 digits)
 Fente en façade pour le dépôt des chèques & billets sans ouvrir le coffre (145 x 10 mm) - At the front deposit slot for checks & banknotes without opening safe (145 x 10 mm)
 Système anti-repêchage - Anti fish baffle
 Serrure d'urgence dissimulée - Hidden emergency lock
 Système d'éclairage intérieur par LED (x 2 Ø5 mm) - Inner LED lighting system (x 2 5 mm Ø)
 Affichage écran LCD - LCD display screen
 Fiche pour boîtier de piles externe - External battery box plug
 Vendu avec un boîtier de piles externe - Supplied with an external battery box

REF.	DIM. EXT. - DIM. INT. (H X L X P MM)	DIM. INT. DE PASSAGE (H X L X P MM)	CARACTÉRISTIQUES SPECIFICATIONS	PORTE/PAROI DOOR/ WALLS (MM)	KG	ACCESSOIRES ACCESSORIES	LIV/PCB
FA62378	440 x 335 x 310 434 x 329 x 245	355 x 245 x 245		6/3	23,3		1/1

COFFRE DE DÉPÔT

Deposit safe

Coffre de dépôt conçu pour mettre rapidement en sécurité les espèces - Deposit safe designed for immediate deposits & secure storage of cash without access to the content of the safe
 Acier monobloc - Monobloc steel frame
 Ø pènes : 25 mm - Bolts Ø : 25 mm
 Ouverture/fermeture par serrure à combinaison mécanique - Opening/closing by mechanical combination lock
 Code unique paramétré en usine (non modifiable) - Unique code set at the factory
 Dispositif anti-repêchage interdisant tout accès au contenu du coffre à partir du tiroir - Anti-fish baffle prevents theft through the deposit door
 Angle d'ouverture de la porte : 180° max. - Door opening angle : 180° max.
 Dimensions trappe de dépôt : 285 x 95 mm - U-Trap deposit drawer size : 285 x 95 mm
 Trappe de dépôt chargement frontal avec basculement du tiroir - Front loading U-Trap deposit slot by drawer tilting system



FA62376



FA62377

REF.	DIM. EXT. - DIM. INT. (H X L X P MM)	DIM. INT. DE PASSAGE (H X L X P MM)	CARACTÉRISTIQUES SPECIFICATIONS	PORTE/PAROI DOOR/ WALLS (MM)	KG	ACCESSOIRES ACCESSORIES	LIV/PCB
FA62376	480 x 350 x 350 474 x 344 x 275	285 x 210 x 275		5/3	24		1/1
FA62377	700 x 350 x 350 694 x 344 x 275	495 x 265 x 275		5/3	32		1/1



COFFRE SPÉCIAL HÔTEL Hotel safe

Coffre adapté aux tablettes, ordinateurs portables 15" & 17" - Suitable for tablets, 15" & 17" laptops

Acier monobloc - Monobloc steel frame

Ø pènes motorisés : 20 mm - Motorized locking bolts Ø : 20 mm

Ouverture/fermeture par serrure électronique - Opening/closing by electronic lock

1 code utilisateur (combinaison numérique de 3 à 6 chiffres) - 1 user code (combination of 3 to 6 digits)

1 code maître (combinaison numérique de 3 à 6 chiffres) - 1 mastercode (combination of 3 to 6 digits)

Serrure d'urgence dissimulée à clé - Hidden emergency lock with key

Angle d'ouverture de la porte : 90° max. - Door opening angle : 90° max.

Affichage écran LCD - LCD display screen

Fiche pour boîtier de piles externe (boîtier non inclus) - External battery box plug (box not included)



REF.	DIM. EXT. - DIM. INT. (H X L X P MM)	DIM. EXT. - DIM. INT. (H X L X P MM)	CARACTÉRISTIQUES SPECIFICATIONS	PORTE/PAROIIS DOOR/ WALLS (MM)	KG	ACCESSOIRES ACCESSORIES	UV/PCB
FA62358 IV	200 x 430 x 370 196 x 426 x 305	138 x 320 x 305		5/2	12,2		1/1
FA62360 IV	230 x 490 x 380 226 x 486 x 320	170 x 370 x 320		5/2	14		1/1
SAV1104 Boîtier de piles externe External battery box	-	-		-	-	-	1/1



SÉCURISER - DÉTECTER

Secure - Detect



COFFRES IGNIFUGES / HYDROFUGES DATA 1H Fireproof / Waterproof Data safes 1h

Coffre ignifuge 1H papier/data : résistance au feu certifiée conforme à la norme UL 60 (60 minutes papier) & ETL 60 (60 minutes média numériques) - Fireproof safe 1H paper/data: fire resistance according to UL 60 (60 minutes paper) & ETL 60 (60 minutes digital media) classification

Protection contre les inondations : résistance à l'eau certifiée conforme à la norme ETL - Protection against flooding : water-resistance according to ETL classification

Acier monobloc sans soudure & matériau isolant ignifuge - Seamless monobloc steel frame & fire-retardant insulating material

Caisson intérieur plastique hermétique/étanche - Inner hermetic/waterproof plastic box

Ø pènes : 25 mm - Bolts Ø : 25 mm

Ouverture/fermeture par serrure électronique - Opening/closing by electronic lock

Mécanisme de verrouillage : 2 à 3 pènes fixes dans la charnière de la porte + 3 à 6 mobiles selon le modèle - Locking mechanism : 2 or 3 stationary locking bolts on hinge side + 3 or 6 movable depending the model

2 codes utilisateurs (combinaison numérique de 3 à 8 chiffres) - 2 user code (combination of 3 to 8 digits)

Angle d'ouverture de la porte : 180° max. - Door opening angle : 180° max.

Compartiment supplémentaire dans la porte (porte-documents) - Additional door compartment (document holders)

Serrure d'urgence dissimulée - Hidden emergency lock



FA62349



FA62351

REF.	DIM. EXT. - DIM. INT. (H X L X P MM)	DIM. INT. DE PASSAGE (H X L X P MM)	CARACTÉRISTIQUES SPECIFICATIONS	PORTE/PAROIS DOOR/WALLS (MM)	KG	ACCESSOIRES ACCESSORIES	UV/PCB
FA62349	356 x 470 x 483 220 x 330 x 325	220 x 330 x 325		22/22	39,65		1/1
FA62351	610 x 530 x 483 475 x 385 x 325	475 x 385 x 325		22/22	61		1/1



COFFRES IGNIFUGES 1H Fireproof safes 1h

Coffre ignifuge 1H papier : Classification UL (norme UL72 Class 350 1H) -
Fireproof safe 1H paper : Classification UL (standard UL72 Class 350 1H)
Acier & matériau composite anti-feu - Steel & fire-retardant composite material
Ø pènes : 20 mm - Bolts Ø : 20 mm

Verrouillage par double ou triple combinaison

- **FS-E20** : double verrouillage serrure électronique & clé unique haute sécurité

- **FS-E38/61** : triple verrouillage automatique serrure électronique, clé unique haute sécurité & poignée rotative

Locking by dual or triple combination

- **FS-E20** : dual security locking system by electronic code & high security master key lock

- **FS-E38/61** : automatic triple security locking system by electronic code, high security master key lock & rotary handle

Mécanisme de verrouillage 2 positions : 2 pènes fixes dans la charnière de la porte + 2 à 4 mobiles selon le modèle - 2-way point locking mechanism : 2 stationary locking bolts on hinge side + 2 to 4 movable depending the model

1 code utilisateur (combinaison numérique de 4 à 8 chiffres) - 1 user code (combination 4 to 8 digits)

Serrure d'urgence dissimulée - Hidden emergency lock

Angle d'ouverture de la porte : 180° max. - Door opening angle : 180° max.

Affichage écran LCD - LCD display screen

Fiche pour boîtier de piles externe - External battery box plug

Vendu avec un boîtier de piles externe - Supplied with an external battery box



FA62345



FA62346



FA62348

REF.	DIM. EXT. - DIM. INT. (H X L X P MM)	DIM. INT. DE PASSAGE (H X L X P MM)	CARACTÉRISTIQUES SPECIFICATIONS	PORTE/PAROIS DOOR/WALLS (MM)	KG	ACCESSOIRES ACCESSORIES	LIV/PCB
FA62345	500 x 355 x 410 310 x 220 x 250	310 x 220 x 250		70/67.5	54		1/1
FA62346	530 x 460 x 500 385 x 305 x 305	385 x 305 x 305		80/70	75,5		1/1
FA62348	700 x 500 x 505 450 x 345 x 335	450 x 345 x 335		80/70	94,7		1/1
SAV1103 Boîtier de piles externe External battery box							1/1

SÉCURISER - DÉTECTER

Secure - Detect



COFFRES IGNIFUGES 1H Fireproof safes 1h

Coffre ignifuge 1H papier : Classification SP (norme NT Fire 017-60 Paper) & UL (norme UL72 Class 350 1H) - Fireproof safe 1H paper : Classification SP (standard NT Fire 017-60 Paper) & UL (standard UL72 Class 350 1H)
 Acier & matériau composite anti-feu - Steel & fire-retardant composite material
 Ø pènes : 16 mm - Bolts Ø : 16 mm
 Déverrouillage par serrure électronique - Electronic unlocking
 Mécanisme de verrouillage 2 positions : 1 pêne fixe dans la charnière de la porte + 2 mobiles - 2-way point locking mechanism : 1 stationary locking bolt on hinge side + 2 movable
 2 codes utilisateur (combinaison numérique à 6 chiffres) - 2 user codes (combination of 6 digits)
 Angle d'ouverture de la porte : 180° max. - Door opening angle : 180° max.
 Affichage écran LCD - LCD display screen



FA62540 N



FA62542 N

REF.	DIM. EXT. - DIM. INT. (H X L X P MM)	DIM. INT. DE PASSAGE (H X L X P MM)	CARACTÉRISTIQUES SPECIFICATIONS	PORTE/PAROIS DOOR/WALLS (MM)	KG	ACCESSOIRES ACCESSORIES	UV/PCB
FA62540N	345 x 425 x 415 240 x 290 x 258	240 x 290 x 258		65/50	34.1		
FA62542N	525 x 410 x 445 360 x 295 x 320	360 x 295 x 320		65/50	55,9		1/1



COFFRES IGNIFUGES 1H

Fireproof safes 1h

Protection contre l'incendie : certifié ECB-S résistance au feu LFS-60P conforme à la norme européenne EN-15659 - Protection against fire. Fire resistance LFS-60P according to european standard protection EN-15659
Construction en acier à double paroi avec béton réfractaire - Monobloc steel frame with double-walled construction. Safe body & door are manufactured with 2 inter-welded walls that are filled with fire resistant concrete

Ø pènes : 16 mm - Bolts Ø : 16 mm

Verrouillage :

- 9020.01/9021.01 : par serrure électronique & bouton pousier
- 9022.01/9024.01/9025.01 : par serrure électronique & poignée + verrouillage automatique

- Locking:

- 9020.01/9021.01 : by electronic lock & thumbturn
- 9022.01/9024.01/9025.01 : by electronic lock & handle + automatic locking

9020.01/9021.01 : mécanisme de verrouillage 2 positions : 1 pêne fixe dans la charnière de la porte + 2 mobiles - 9020.01/9021.01 : 2-way point locking mechanism : 1 stationary locking bolt on hinge side + 2 movable

9022.01/9024.01/9025.01 : verrouillage fermeture par tringlerie à 3 axes / 4 à 7 points selon le modèle - 9022.01/9024.01/9025.01 : 3-way combo locking bolts / 4 to 7 points depending the model

1 code utilisateur (combinaison numérique de 4 à 6 chiffres) - 1 user code (combination of 4 to 6 digits)

Angle d'ouverture de la porte : 180° max. - Door opening angle : 180° max.

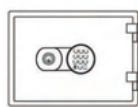

9020.01

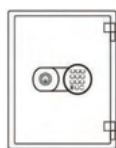

9021.01



9022.01

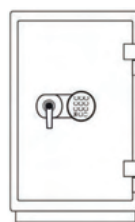

9024.01



9025.01

REF.	DIM. EXT. - DIM. INT. (H X L X P MM)	DIM. INT. DE PASSAGE (H X L X P MM)	CARACTÉRISTIQUES SPECIFICATIONS	PORTE/PAROIS DOOR/WALLS (MM)	KG	ACCESSOIRES ACCESSORIES	LIV/PCB
9020.01	315 x 445 x 445 210 x 305 x 310	210 x 305 x 310		95/50	38		1/1
9021.01	510 x 445 x 445 400 x 335 x 295	400 x 335 x 295		95/50	49,6		1/1
9022.01	790 x 485 x 490 515 x 330 x 315	515 x 330 x 315		95/50	107,2		1/1
9024.01	1255 x 710 x 620 875 x 530 x 420	875 x 530 x 420		95/50	290		1/1
9025.01	1710 x 710 x 620 1345 x 535 x 400	1345 x 535 x 400		95/50	390		1/1

SÉCURISER - DÉTECTER

Secure - Detect



COFFRES À VALEUR ASSURABLE

Burglary resistant safes



Protection contre l'effraction : certifié ECB-S conforme à la norme européenne EN 14450 Classe S2 - Burglary resistance according to european standard protection EN 14450 Grade S2

Construction en acier monobloc à double paroi - Monobloc steel frame with double-walled construction

Mécanisme de verrouillage sécurisé contre les attaques par perforation - Integrated lock secured from drill attacks

Tringlerie 3 axes / 4 à 6 points selon le modèle - 3-way locking bolts / 4 to 6 points depending on the model

Montant maximum assurable : 3000€ (à faire valider par votre compagnie d'assurance) - Maximum insurable amount (to be validated by your insurance company) : 3000€*

Ø pènes : 20 mm - Bolts Ø : 20 mm

Déverrouillage par serrure à clé unique (2 clés fournies) - Unlocking by master key (2 keys supplied)

Angle d'ouverture de la porte : 90° max. - Door opening angle : 90° max.

Fixation murale complémentaire - Anchoring to the floor and back wall

*French standard



Tous les coffres à valeur assurable doivent être ancrés sur un sol béton.



9015.07



9015.18



9015.31



9015.51



9015.61



9015.78

REF.	DIM. EXT. - DIM. INT. (H X L X P MM)	DIM. INT. DE PASSAGE (H X L X P MM)	CARACTÉRISTIQUES SPECIFICATIONS	PORTE/PAROIS DOOR/WALLS (MM)	KG	ACCESSOIRES ACCESSORIES	UV/PCB
9015.07	220 x 350 x 300 135 x 290 x 190	135 x 290 x 190		30/40	15		1/1
9015.18	300 x 445 x 400 215 x 405 x 290	215 x 330 x 290		30/40	27		1/1
9015.31	450 x 445 x 400 365 x 405 x 290	365 x 340 x 290		30/40	30		1/1
9015.51	600 x 445 x 400 515 x 405 x 285	515 x 330 x 285		30/40	43		1/1
9015.61	800 x 445 x 400 715 x 405 x 290	715 x 330 x 290		30/40	55		1/1
9015.78	1000 x 445 x 405 920 x 405 x 290	920 x 330 x 290		30/40	63		1/1



COFFRES À VALEUR ASSURABLE Burglary resistant safes

Protection contre l'effraction : certifié ECB-S conforme à la norme européenne EN 14450 Classe S2 - Burglary resistance according to european standard protection EN 14450 Grade S2

Construction en acier monobloc à double paroi - Monobloc steel frame with double-walled construction

Mécanisme de reverrouillage intégré & verrouillage sécurisé contre les attaques par perforation - Integrated relocker & lock secured from drill attacks
Tringlerie 3 axes / 4 à 6 points selon le modèle - 3-way locking bolts / 4 to 6 points depending on the model

Montant maximum assurable : 3000€ (à faire valider par votre compagnie d'assurance) - Maximum insurable amount (to be validated by your insurance company) : 3000€*

Ø pènes : 20 mm - Bolts Ø : 20 mm

Déverrouillage par serrure électronique Classe A - Electronic unlocking Grade A
1 code utilisateur (combinaison numérique à 6 chiffres) - 1 user code (combination of 6 digits)

Angle d'ouverture de la porte : 90° max. - Door opening angle : 90° max.

Fiche pour alimentation externe de secours - External power supply plug

Fixation murale complémentaire - Anchoring to the floor and back wall

*French standard



Tous les coffres à valeur assurable doivent être ancrés sur un sol béton.

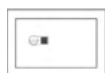

9015.18 EL

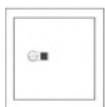

9015.31 EL



9015.51 EL

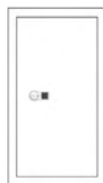

9015.61 EL



9015.78 EL

REF.	DIM. EXT. - DIM. INT. (H X L X P MM)	DIM. INT. DE PASSAGE (H X L X P MM)	CARACTÉRISTIQUES SPECIFICATIONS	PORTE/PAROIS DOOR/WALLS (MM)	KG	ACCESSOIRES ACCESSORIES	LIV/PCB
9015.18 EL	300 x 445 x 410 215 x 405 x 290	215 x 330 x 290		30/40	27,2		1/1
9015.31 EL	450 x 445 x 410 365 x 405 x 290	365 x 340 x 290		30/40	30,1		1/1
9015.51 EL	600 x 445 x 410 515 x 405 x 285	515 x 330 x 285		30/40	43		1/1
9015.61 EL	800 x 445 x 410 715 x 405 x 290	715 x 330 x 290		30/40	55		1/1
9015.78 EL	1000 x 445 x 415 920 x 405 x 290	920 x 330 x 290		30/40	62,9		1/1

SÉCURISER - DÉTECTER

Secure - Detect



COFFRES À VALEUR ASSURABLE IGNIFUGES Burglary resistant safes

Protection contre l'effraction : certifié ECB-S conforme à la norme européenne EN 14450 Classe S2 - Burglary resistance according to european standard protection EN 14450 Grade S2

Protection contre l'incendie : certifié ECB-S résistance au feu LFS-30P conforme à la norme européenne EN-15659 - Protection against fire : fire resistance LFS-30P according to european standard protection EN-15659

Construction en acier monobloc à double paroi rempli avec du béton réfractaire - The safe body and door are manufactured with 2 inter-welded walls that are filled with fire resistant concrete

Mécanisme de reverrouillage intégré & verrouillage sécurisé contre les attaques par perforation - Integrated relocker & lock secured from drill attacks
Tringlerie 3 axes / 4 points - 3-way locking bolts / 4 points

Montant maximum assurable : 3000€ (à faire valider par votre compagnie d'assurance) - Maximum insurable amount (to be validated by your insurance company) : 3000€*

Ø pènes : 20 mm - Bolts Ø : 20 mm

Déverrouillage par serrure à clé unique ou serrure électronique Classe A (pour les modèles EL) - Unlocking by master key or electronic lock Grade A (for models EL)

Angle d'ouverture de la porte : 180° max. - Door opening angle : 180° max.

*French standard

 **Tous les coffres à valeur assurable doivent être ancrés sur un sol béton.**



**Serrure à digicode sur commande
(délai 6 à 8 semaines)
Digital lock on request
(delay 6 to 8 weeks)**

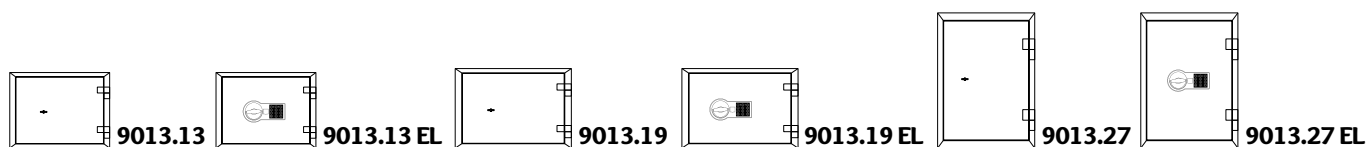

REF.	DIM. EXT. - DIM. INT. (H X L X P MM)	DIM. INT. DE PASSAGE (H X L X P MM)	CARACTÉRISTIQUES SPECIFICATIONS	PORTE/PAROIS DOOR/WALLS (MM)	KG	ACCESSOIRES ACCESSORIES	LIV/PCB
9013.13	300 x 427 x 410 180 x 316 x 225	180 x 316 x 225	    	95/55	49		1/1
9013.13 EL	300 x 427 x 410 180 x 316 x 225	180 x 316 x 225	    	95/55	49	 	1/1
9013.19	315 x 445 x 475 200 x 325 x 290	200 x 325 x 290	    	95/55	57		1/1
9013.19 EL	315 x 445 x 475 200 x 325 x 290	200 x 325 x 290	    	95/55	57	 	1/1
9013.27	490 x 360 x 475 375 x 235 x 280	375 x 235 x 280	    	95/55	66		1/1
9013.27 EL	490 x 360 x 475 375 x 235 x 280	375 x 235 x 280	    	95/55	66	 	1/1



COFFRES À VALEUR ASSURABLE IGNIFUGES

Burglary resistant safes

Protection contre l'effraction : certifié A2P Grade 1 conforme à la norme européenne EN 1143-1 Classe I - Burglary resistance EN 1143-1, Grad 1 (A2P)

Protection contre l'incendie : certifié ECB-S résistance au feu LFS-30P conforme à la norme européenne EN-15659 - Protection against fire. Fire resistance LFS-30P according to european standard protection EN-15659

Construction en acier monobloc à double paroi rempli avec du béton réfractaire - The safe body and door are manufactured with 2 inter-welded walls that are filled with fire resistant concrete

Mécanisme de verrouillage sécurisé contre les attaques par perforation - Integrated relocker & lock secured from drill attacks

Tringlerie 3 axes / 6 points - 3-way locking bolts / 6 points

Montant maximum assurable : 25000€ (à faire valider par votre compagnie d'assurance) - Maximum insurable amount (to be validated by your insurance company) : 25000€*

Ø pènes : 20 mm - Bolts Ø : 20 mm

Déverrouillage par serrure à clé unique ou serrure électronique Classe A (pour les modèles EL / fiche pour alimentation externe de secours) - Unlocking by master key or electronic lock Grade A (for models EL / external power supply plug)

Angle d'ouverture de la porte : 180° max. - Door opening angle : 180° max.

*French standard



Tous les coffres à valeur assurable doivent être ancrés sur un sol béton.



Serrure à digicode sur commande (délai 6 à 8 semaines)
Digital lock on request (delay 6 to 8 weeks)

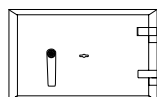

FA62352

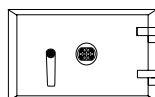

FA62353

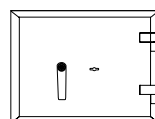

FA62354

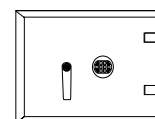

FA62355

REF.	DIM. EXT. - DIM. INT. (H X L X P MM)	DIM. INT. DE PASSAGE (H X L X P MM)	CARACTÉRISTIQUES SPECIFICATIONS	PORTE/PAROIS DOOR/WALLS (MM)	KG	ACCESSOIRES ACCESSORIES	LIV/PCB
FA62352	340 x 500 x 385 260 x 420 x 210	240 x 395 x 210		30/40	104		1/1
FA62353	340 x 500 x 385 260 x 420 x 210	240 x 395 x 210		30/40	104		1/1
FA62354	440 x 500 x 430 360 x 420 x 300	340 x 390 x 300		30/40	143		1/1
FA62355	440 x 500 x 430 360 x 420 x 300	340 x 390 x 300		30/40	143		1/1

SÉCURISER - DÉTECTER

Secure - Detect



COFFRES À VALEUR ASSURABLE IGNIFUGES Burglary resistant safes



Protection contre l'effraction : conforme à la norme européenne EN 1143-1, Classe II - Burglary resistance EN 1143-1, Grade II

Protection contre l'incendie : certifié ECB-S résistance au feu LFS-30P conforme à la norme européenne EN-15659 (en option) - Protection against fire. Fire resistance LFS-30P according to european standard protection EN-15659 (in option)

Construction en acier monobloc à double paroi rempli avec du béton réfractaire - The safe body and door are manufactured with 2 inter-welded walls that are filled with fire resistant concrete

Mécanisme de verrouillage sécurisé contre les attaques par perforation - Integrated relocker & lock secured from drill attacks

Tringlerie 3 axes / 8 points - 3-way locking bolts / 8 point

Montant maximum assurable : 35000€ (à faire valider par votre compagnie d'assurance) - Maximum insurable amount (to be validated by your insurance company) : 35000€*

Ø pènes : 20 mm - Bolts Ø : 20 mm

Déverrouillage par serrure à clé unique ou serrure électronique Classe A (pour les modèles EL / fiche pour alimentation externe de secours) - Unlocking by master key or electronic lock Grade A (for models EL / external power supply plug)

Angle d'ouverture de la porte : 180° max. - Door opening angle : 180° max.

Fixation murale complémentaire - Anchoring to the floor and back wall

*French standard



Tous les coffres à valeur assurable doivent être ancrés sur un sol béton.



Serrure à digicode sur commande (délai 6 à 8 semaines)
Digital lock on request (delay 6 to 8 weeks)

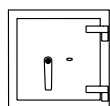

9017.46

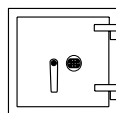

9017.50 EL

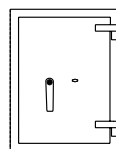

9017.67

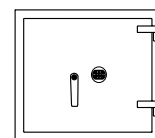

9017.60 EL

REF.	DIM. EXT. - DIM. INT. (H X L X P MM)	DIM. INT. DE PASSAGE (H X L X P MM)	CARACTÉRISTIQUES SPECIFICATIONS	PORTE/PAROIS DOOR/WALLS (MM)	KG	ACCESSOIRES ACCESSORIES	LIV/PCB
9017.46	460 x 470 x 470 333 x 355 x 319	460 x 470 x 470 333 x 355 x 319		92/58	179		1/1
9017.46 EL	460 x 470 x 470 333 x 355 x 319	460 x 470 x 470 333 x 355 x 319		92/58	179		1/1
9017.50	500 x 510 x 510 373 x 395 x 359	500 x 510 x 510 373 x 395 x 359		92/58	220		1/1
9017.50 EL	500 x 510 x 510 373 x 395 x 359	500 x 510 x 510 373 x 395 x 359		92/58	220		1/1
9017.67	670 x 510 x 510 544 x 395 x 359	670 x 510 x 510 544 x 395 x 359		92/58	279		1/1
9017.67 EL	670 x 510 x 510 544 x 395 x 359	670 x 510 x 510 544 x 395 x 359		92/58	279		1/1
9017.60	610 x 680 x 550 485 x 550 x 355	485 x 550 x 355		92/58	305		1/1
9017.60 EL	610 x 680 x 550 485 x 550 x 355	485 x 550 x 355		92/58	305		1/1



COFFRES À VALEUR ASSURABLE IGNIFUGES Burglary resistant safes



Protection contre l'effraction : conforme à la norme européenne EN 1143-1, Classe IV - Burglary resistance EN 1143-1, Grade IV

Protection contre l'incendie : certifié ECB-S résistance au feu LFS-30P conforme à la norme européenne EN-15659 (en option) - Protection against fire. Fire resistance LFS-30P according to european standard protection EN-15659 (in option)

Construction en acier monobloc à double paroi rempli avec du béton Haute Performance - The safe body and door are manufactured with 2 inter-welded walls that are filled with special type of ultra High Performance Concrete

Remplissage coupe-feu selon la norme DIN 4102 - Flame retardant filling in accordance with DIN 4102 standard

Mécanisme de verrouillage Haute Performance avec plaque de verre et serrures anti-perforation - Integrated relocker with glass plate, locks secured from drill attacks

Tringlerie 3 axes / 12 points - 3-way locking bolts / 12 points

Montant maximum assurable : 110000€ (à faire valider par votre compagnie d'assurance) - Maximum insurable amount (to be validated by your insurance company) : 110000€*

Ø pènes : 20 mm - Bolts Ø : 20 mm

Verrouillage : double serrure à clés (2 clés de chaque serrure fournies) ou serrure électronique classe B et une serrure haute sécurité à clé (2 clés fournies) - Locking: double key lock (2 keys of each lock provided) or electronic lock class B and a high security key lock (2 keys provided)

Angle d'ouverture de la porte : 180° max. - Door opening angle : 180° max.

*French standard

Tous les coffres à valeur assurable doivent être ancrés sur un sol béton.



**Coffres sur commande
(délai 6 à 8 semaines)
Safes on request
(delay 6 to 8 weeks)**

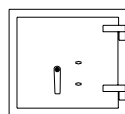

9019.55

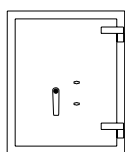

9019.67

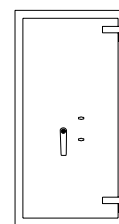

9019.85

REF.	DIM. EXT. - DIM. INT. (H X L X P MM)	DIM. INT. DE PASSAGE (H X L X P MM)	CARACTÉRISTIQUES SPECIFICATIONS	PORTE/PAROIS DOOR/WALLS (MM)	KG	ACCESSOIRES ACCESSORIES	UV/PCB
9019.55	550 x 550 x 530 423 x 435 x 336	550 x 550 x 530 423 x 435 x 336		125/58	300		1/1
9019.55 EL	550 x 550 x 530 423 x 435 x 336	550 x 550 x 530 423 x 435 x 336		125/58	300		1/1
9019.67	670 x 550 x 530 543 x 435 x 336	670 x 550 x 530 543 x 435 x 336		125/58	366		1/1
9019.67 EL	670 x 550 x 530 543 x 435 x 336	670 x 550 x 530 543 x 435 x 336		125/58	366		1/1
9019.85	840 x 550 x 530 713 x 435 x 336	840 x 550 x 530 713 x 435 x 336		125/58	411		1/1
9019.85 EL	840 x 550 x 530 713 x 435 x 336	840 x 550 x 530 713 x 435 x 336		125/58	411		1/1

SÉCURISER - DÉTECTER

Secure - Detect



ARMOIRES FORTES

Safe cabinets



Protection contre l'effraction EN 14450 Classe 2 (Certification IMP) -

Burglary resistance EN 14450, Grade 2 (Certification IMP)

Construction en acier monobloc à double paroi : l'espace entre les parois interne et externe est rempli de matériau d'isolation thermique multicouche qui protège le contenu contre l'incendie durant 30 mn -

Monobloc steel frame with double-walled construction : the gap between the inner & outer walls is filled with heat insulating multilayer material which protects the contents against fire during 30 mn

Montant maximum assurable : 3000€ (à faire valider par votre compagnie d'assurance) - Maximum insurable amount (to be validated by your insurance company) : 3000€*

Ø pènes : 20 mm - Bolts Ø : 20 mm

Ouverture/fermeture par poignée - Opening/closing by handle

Serrure à clé unique haute sécurité à double panneton (2 clés fournies) - Double-bit high security master key lock (2 keys supplied)

Tringlerie 3 axes / 5 points - 3-way locking bolts / 5 points

Angle d'ouverture de la porte : 180° max. - Door opening angle : 180° max.

Étagères compatibles pour les dossiers suspendus - Compatible shelves for suspension files

*French standard

Tous les coffres à valeur assurable doivent être ancrés sur un sol béton.



Serrure à digicode sur commande

(délai 6 à 8 semaines)

Digital lock on request

(delay 6 to 8 weeks)



9033.01



9035.01

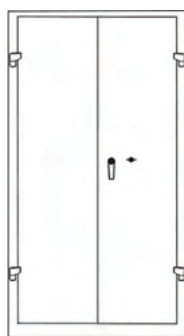

9034.01

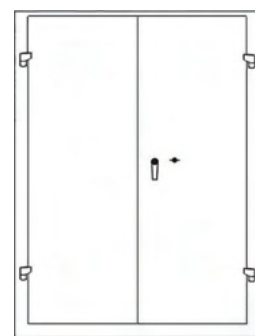

9036.01

REF.	DIM. EXT. - DIM. INT. (H X L X P MM)	DIM. INT. DE PASSAGE (H X L X P MM)	CARACTÉRISTIQUES SPECIFICATIONS	PORTE/PAROIS DOOR/WALLS (MM)	KG	ACCESSOIRES ACCESSORIES	LIV/PCB
9033.01	1220 x 930 x 560 1070 x 810 x 415	1070 x 810 x 415		60/85	80		1/1
9035.01	1220 x 600 x 560 1075 x 500 x 410	1075 x 500 x 410		60/85	71		1/1
9034.01	1950 x 930 x 560 1800 x 815 x 415	1800 x 815 x 415		60/85	142		1/1
9036.01	1950 x 1250 x 560 1790 x 1140 x 415	1790 x 1140 x 415		60/85	180		1/1



ARMOIRES À FUSILS GS

GS guns cabinets

- Porte fusils - Guns holder
- Rangement à munitions séparé et verrouillable (2 clés fournies)
Separable lockable ammo storage (2 keys supplied)
- Acier monobloc - Monobloc steel frame
- Ø pènes : 22 mm - Bolts Ø : 22 mm
- Verrouillage par tringlerie à 3 axes / 5 points - 3-way combo locking bolts
5 points
- Ouverture/fermeture par serrure à clé unique (2 clés fournies) - Opening/
closing by master key lock (2 keys supplied)
- Angle d'ouverture de la porte : 90° max. - Door opening angle : 90° max.



9200.01



9200.02



9200.03

REF.	DIM. EXT. - DIM. INT. (H X L X P MM)	DIM. INT. DE PASSAGE (H X L X P MM)	CARACTÉRISTIQUES SPECIFICATIONS	PORTE/PAROIS DOOR/WALLS (MM)	KG	ACCESSOIRES ACCESSORIES	UV/PCB
9200.01	1450 x 250 x 270 1265 x 246 x 170	1225 x 140 x 170		3/2	36,35		1/1
9200.02	1450 x 350 x 340 1250 x 346 x 250	1225 x 210 x 250		3/2	48,95		1/1
9200.03	1450 x 490 x 380 1265 x 486 x 270	1225 x 360 x 270		3/2	60,5		1/1

SÉCURISER - DÉTECTER









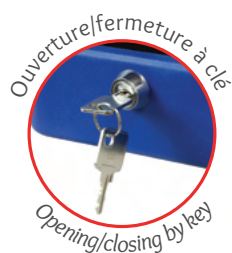

















Secure - Detect

CAISSES À MONNAIE / CASH BOXES

CM FIRST

Corps métal (tôle d'acier emboutie) - Metal frame (pressed steel)
 Ouverture/fermeture par serrure à clé (2 clés fournies) - Opening/closing by key lock (2 keys supplied)
 Casier plastique amovible 6 à 9 compartiments pouvant contenir des pièces, billets et chèques - Removable plastic tray with 6 to 9 compartments for coins, banknotes & checks
 Poignée de transport - Carry handle
 Finition mate sablée - Sand-blasted matt finish



MODÈLE MODEL	REF.	DIM. EXT. - DIM. INT. (H X L X P MM)	CARACTÉRISTIQUES SPECIFICATIONS	CONDITIONNEMENT PACKING	LIV/PCB	
CM FIRST XS	FA62113	80 x 152 x 115	Métal / Metal	  	Vrac / Bulk	1/18
CM FIRST XS	FA62110	80 x 152 x 115	Métal / Metal	  	Vrac / Bulk	1/18
CM FIRST S	FA62151	90 x 200 x 160	Métal / Metal	  	Vrac / Bulk	1/10
CM FIRST M	FA62149	90 x 250 x 180	Métal / Metal	  	Vrac / Bulk	1/8
CM FIRST L	FA62150	90 x 300 x 240	Métal / Metal	  	Vrac / Bulk	1/6
CM FIRST S	FA62121	90 x 200 x 160	Métal / Metal	  	Vrac / Bulk	1/10
CM FIRST S	FA62141	90 x 200 x 160	Métal / Metal	  	Vrac / Bulk	1/10
CM FIRST M	FA62139	90 x 250 x 180	Métal / Metal	  	Vrac / Bulk	1/8
CM FIRST L	FA62130	90 x 300 x 240	Métal / Metal	  	Vrac / Bulk	1/6

CM ESSENTIAL

Acier peinture époxy - Steel with epoxy painting

Casier à monnaie : compartiment amovible, serrure à cylindre + 2 clefs

Cash tray : removable cash compartment, roller-lock with 2 keys

Poignée de transport en acier nickelé - Nickel-plated carry handle



MODÈLE MODEL	REF.	DIM. EXT. - DIM. INT. (H X L X P MM)	CARACTÉRISTIQUES SPECIFICATIONS	CONDITIONNEMENT PACKING	LIV/PCB	
CM ESSENTIAL XS	FA62114	80 x 160 x 125	Métal / Metal		Vrac / Bulk	1/18
CM ESSENTIAL S	FA62122	90 x 205 x 160	Métal / Metal		Vrac / Bulk	1/10
CM ESSENTIAL M	FA62137	90 x 255 x 205	Métal / Metal		Vrac / Bulk	1/8
CM ESSENTIAL L	FA62133	90 x 330 x 240	Métal / Metal		Vrac / Bulk	1/6

CM PREMIUM

Corps métal (tôle d'acier emboutie) - Metal frame (pressed steel)

Ouverture/fermeture par serrure à clé (2 clés fournies) + bouton poussoir - Opening/closing by key lock (2 keys supplied) + push button combination

Casier plastique amovible 3 compartiments pouvant contenir des pièces, billets et chèques - Removable plastic tray with 3 compartments for coins, banknotes & checks

Poignée de transport - Carry handle

Finition mate lisse - Sleek matt finish



MODÈLE MODEL	REF.	DIM. EXT. - DIM. INT. (H X L X P MM)	CARACTÉRISTIQUES SPECIFICATIONS	CONDITIONNEMENT PACKING	LIV/PCB	
PREMIUM S	FA62142	90 x 200 x 160	Métal / Metal		Boîte / Box	1/10
PREMIUM L	FA62146	90 x 300 x 240	Métal / Metal		Boîte / Box	1/6

SÉCURISER - DÉTECTER

Secure - Detect

MINI COMFORTA

Corps métal - Metal frame

Ouverture/fermeture par serrure à clé (2 clés fournies) - Opening/closing by key lock (2 keys supplied)

Monnayeur pièces Euro amovible - Removable Euro cash tray

Emplacement pour billets, chèques,... - Emplacement banknotes, checks,...

Dimensions monnayeur (HxLxP) : 18 x 224 x 109 mm - Coin tray dimensions (HxLxW) : 18 x 224 x 109 mm

Finition peinture époxy - Epoxy paint finish



COMFORTA



Corps métal (fabrication tôle d'acier emboutie) - Metal frame (pressed steel)

Ouverture/fermeture par serrure à clé (2 clés fournies) - Opening/closing by key lock (2 keys supplied)

Monnayeur pièces/billets amovible sur support articulé & 2 pieds rétractables - Removable coins/banknotes tray fixed on articulated support & 2 retractable feet

Dimensions monnayeur (HxLxP) : 32/70 x 235 x 185 mm - Coin tray dimensions (HxLxW) : 32/70 x 235 x 185 mm

Poignée de transport ergonomique - Ergonomic carry handle

Finition mate sablée - Sand-blasted matt finish



MODÈLE MODEL	REF.	DIM. EXT. - DIM. INT. (H X L X P MM)	CARACTÉRISTIQUES SPECIFICATIONS	CAPACITÉ D'ENCAISSEMENT COIN CAPACITY	CONDITIONNEMENT PACKING	UV/PCB
MINI COMFORTA	FA62120	90 x 250 x 180	Métal / Metal 	77,60 €	Vrac / Bulk	1/8
COMFORTA	26515	90 x 300 x 240	Métal / Metal  	226,05 €	Vrac / Bulk	1/6

DUOBOX EURO



Corps métal (tôle d'acier emboutie) - Metal frame (pressed steel)

Ouverture/fermeture par serrure à clé (2 clés fournies) - Opening/closing by key lock (2 keys supplied)

Monnayeur pièces/billets amovible sur support articulé - Removable coins/banknotes tray fixed on articulated support

Dimensions monnayeur (HxLxP) : 16 x 259 x 170 mm - Coin tray dimensions (HxLxW) : 16 x 259 x 170 mm

2 poignées de transport ergonomiques - 2 ergonomic carry handles

Finition brillante - Gloss finish



MODÈLE MODEL	REF.	DIM. EXT. - DIM. INT. (H X L X P MM)	CARACTÉRISTIQUES SPECIFICATIONS	CAPACITÉ D'ENCAISSEMENT COIN CAPACITY	CONDITIONNEMENT PACKING	UV/PCB
DUOBOX EURO	26510	115 x 290 x 235	Métal / Steel  	152,10 €	Vrac / Bulk	1/6

MONNAYEURS / COIN TRAYS



167-10 / 206-40 / 231-55

Monnayeur à pièces monobloc - Monobloc coin tray

Corps ABS - Shockproof ABS

Goulottes profondes & compartimentées par 5 pièces - Graduated columns with compartments per 5 pieces



MODÈLE MODEL	REF.	DIM. EXT. - DIM. INT. (H X L X P MM)	CARACTÉRISTIQUES SPECIFICATIONS	CAPACITÉ D'ENCAISSEMENT COIN CAPACITY	CONDITIONNEMENT PACKING	UV/PCB
167-10	35297	155 x 191.5 x 19	ABS 	167,10 €	Vrac / Bulk	1/80
206-40	35298	172.5 x 242.5 x 19	ABS 	206,40 €	Vrac / Bulk	1/80
231-55	35299	232.5 x 292.5 x 19	ABS 	231,55 €	Vrac / Bulk	1/40

226-05 / 226-05C



Monnayeur à pièces monobloc

- 226-05C : avec couvercle

- 226-05 : sans couvercle

Monobloc coin tray

- 226-05C : with cover

- 226-05 : without cover

Corps PS antichoc - Shockproof PS frame



Goulottes profondes & compartimentées par 5 pièces - Graduated columns with compartment per 5pcs

2 pieds rétractables - 2 retractable feet

Capacité d'encaissement : 226,05 € - Coin capacity : 226,05 €

Compatible caisses à monnaies «Comforta» (26515) - Compatible with combined cash boxes «Comforta» (26515)



MODÈLE MODEL	REF.	DIM. EXT. - DIM. INT. (H X L X P MM)	CARACTÉRISTIQUES SPECIFICATIONS	CAPACITÉ D'ENCAISSEMENT COIN CAPACITY	CONDITIONNEMENT PACKING	UV/PCB
226-05	35302	30 x 235 x 180	PS 	226,05 €	Vrac / Bulk	1/60
226-05C	35303	33/67 x 232 x 183	PS 	226,05 €	Vrac / Bulk	1/44

SÉCURISER - DÉTECTER

Secure - Detect

ÉTUIS À MONNAIE / COIN TUBES



THE CONTAINER™



Étui à monnaie transparent pour pièces Euro - Transparent Euro coins case
 Double coque plastique (PET) en matière recyclée & recyclable - Double plastic shell with recycled & recyclable ecofriendly material
 Code couleur européen pour pièces - Specific colour european code per coins
 Divisé en compartiments de 5 pièces quelque soit le pays d'origine (calibrage européen) - Divided into 5 pieces compartments whatever the origin country is (european calibration)
 Résistant aux chocs, réutilisable plusieurs fois - Impact resistant, reusable several times

TUBE PIÈCES EURO

Tube à monnaie pour pièces Euro - Euro coins tube
 Papier recyclé & recyclable - Ecofriendly paper : recycled & recyclable
 Code couleur européen pour pièces - Specific colour european code per coins
 Papier 80g 100% recyclé, 100% recyclable, biodegradable - 80g paper, 100% recycled, 100% recyclable, biodegradable
 Respecte les normes Banque de France et Banque Centrale Européenne (dimensions, couleurs Pantone, résistance) - Complies with Banque de France and European Central Bank standards (dimensions, Pantone colours, resistance)
 Les tubes s'emboîtent les uns dans les autres pour gain de stockage - Tubes fit together to save storage space

MODÈLE MODEL	REF.	CAPACITÉ (€) CAPACITY (€)	CARACTÉRISTIQUES SPECIFICATIONS	CONDITIONNEMENT PACKING	LIV/PCB	
	FA62263	50 (25 x 2€)	R-PET		Vrac / Bulk (x100)	1/100
	FA62262	25 (25 x 1€)	R-PET		Vrac / Bulk (x100)	1/100
	FA62261	20 (40 x 0,50€)	R-PET		Vrac / Bulk (x100)	1/72
	FA62266	8 (40 x 0,20€)	R-PET		Vrac / Bulk (x100)	1/80
	FA62268	4 (40 x 0,10€)	R-PET		Vrac / Bulk (x100)	1/96
	FA62270	2,50 (50 x 0,05€)	R-PET		Vrac / Bulk (x100)	1/80
	FA62271	1 (50 x 0,02€)	R-PET		Vrac / Bulk (x100)	1/108
	FA62272	0,50 (50 x 0,01€)	R-PET		Vrac / Bulk (x100)	1/96
FA62264	50 étuis de chaque 50 cases of each		R-PET	-	Vrac / Bulk (x400)	1/16
	FA62281	50 (25 x 2€)	Papier / Paper		Vrac / Bulk (x96)	1/21
	FA62280	25 (25 x 1€)	Papier / Paper		Vrac / Bulk (x96)	1/21
	FA62279	20 (40 x 0,50€)	Papier / Paper		Vrac / Bulk (x96)	1/21
	FA62278	8 (40 x 0,20€)	Papier / Paper		Vrac / Bulk (x96)	1/21
	FA62277	4 (40 x 0,10€)	Papier / Paper		Vrac / Bulk (x96)	1/21
	FA62276	2,50 (50 x 0,05€)	Papier / Paper		Vrac / Bulk (x96)	1/21
	FA62275	1 (50 x 0,02€)	Papier / Paper		Vrac / Bulk (x96)	1/21
	FA62274	0,50 (50 x 0,01€)	Papier / Paper		Vrac / Bulk (x96)	1/21

ACCESSOIRES BILLETS / BANKNOTES ACCESSORIES

BRACELETS EURO



Bracelets pour billets Euro - Euro banknotes bands
PEBD recyclable - Recyclable LDPE
Code couleur par billets - Specific colour code per banknotes
Capacité : 20 billets/bracelet - Capacity : 20 banknotes/band

MODÈLE MODEL	REF.	CAPACITÉ (€) CAPACITY (€)	CARACTÉRISTIQUES SPECIFICATIONS	CONDITIONNEMENT PACKING	LIV/PCB
	FA62289	100 (20 x 5€)	PEBD / LDPE	Vrac / Bulk (x100)	1/100
	FA62290	200 (20 x 10€)	PEBD / LDPE	Vrac / Bulk (x100)	1/100
	FA62291	400 (20 x 20€)	PEBD / LDPE	Vrac / Bulk (x100)	1/100
	FA62292	1000 (20 x 50€)	PEBD / LDPE	Vrac / Bulk (x100)	1/100

SACHET SÉCURITÉ BILLETS

Sachet de sécurité inviolable opaque pour billets - Opaque tamper-proof bank notes security bag
Double numérotation avec code barre type 39 - Double numbering with barcode type 39
Fermeture ruban de sécurité anti-fraude - Anti-fraud security sealing
Colle permanente - Permanent glue
PE co-extrudé opaque 70µm - 70µm co-extruded opaque PE
Agréées AXYTRANS compatible SQS & transport traditionnel - AXYTRANS approved, SQS compatible, traditional transport



SACHET SÉCURITÉ MONNAIE

Sachet de sécurité inviolable transparent pour monnaie (max 5 kg) - Tamper-proof transparent bank coins security bag (max 5 kg)
Double numérotation avec code barre type 39 - Double numbering with barcode type 39
Fermeture colle permanente 20 mm - 20 mm permanent glue sealing
PE co-extrudé transparent 100µm - 100µm co-extruded transparent PE
Transport traditionnel - Traditional transport



MODÈLE MODEL	REF.	DIM. EXT. - DIM. INT. (H X L X P MM)	CARACTÉRISTIQUES SPECIFICATIONS	CONDITIONNEMENT PACKING	LIV/PCB
SACHET BILLETS BANKNOTES SECURITY BAG	14202-1	295 x 265 (+30)	PE	Sachet / Bag (x100)	1/5
SACHET MONNAIE BANK COINS SECURITY BAG	15002-1	198 x 330 (+30)	PE	Sachet / Bag (x100)	1/10

SÉCURISER - DÉTECTER



Secure - Detect

TIROIR-CAISSE / CASH DRAWER

TIROIR-CAISSE

Tiroir-caisse double fente en façade - Dual drop slot cash drawer
Corps en acier laminé - Laminated steel frame
Ouverture/fermeture par serrure à clé 3 positions (2 clés fournies) - Opening/closing by key lock 3 positions (2 keys supplied)
5 compartiments pour billets (2 largeurs, 67 & 68 mm) à pinces & ajustable - 5 banknotes compartments adjustable & with holding clip (2 sizes, 67 & 68 mm)
8 compartiments pour pièces - 8 coin compartments
Plateau intérieur amovible - Removable inner coin tray
Interface RJ12 (câble fourni) - RJ12 interface (cable supplied)





MODÈLE MODEL	REF.	DIM. EXT. - DIM. INT. (H X L X P MM)	CARACTÉRISTIQUES SPECIFICATIONS	CONDITIONNEMENT PACKING	LIV/PCB
TIROIR-CAISSE CASH DRAWER	K60300	100 x 410 x 415	Acier / Steel 	Boîte / Box	1/2
CASIER POUR BILLETS COMPARTEMENTS FOR NOTES	9996.328	63 x 359 x 328	Métal / Steel 	Vrac / Bulk	1/5
CASIER POUR PIÈCES COMPARTEMENTS FOR COINS	9996.329	45 x 342 x 132	Métal / Steel 	Vrac / Bulk	1/21



EUROWALLET®

Sacoche ventrale ergonomique haute qualité avec monnaie € - Ergonomic & ventral high quality Euro coins storage carrying bag
Monnaieur 8 pièces déclipable & interchangeable - Interchangeable & removable 8 cylinders coin holder tailored to the Euro coins sizes
4 compartiments de rangement pour billets, chèques, tickets restaurant,...
1 compartiment zippé - 1 zippered compartment
Fermeture magnétique - Rabat extérieur aimanté - Magnetic closure - Magnetised external flap
Ceinture à clip réglable & ajustable à la taille - Easy fit with waist adjustable belt clip
Tissu nylon - PVC imperméable - Nylon fabric - Waterproof PVC
Capacité d'encaissement : 100 € - Coin capacity : 100 €



MODÈLE MODEL	REF.	DIM. EXT. - DIM. INT. (H X L X P MM)	CARACTÉRISTIQUES SPECIFICATIONS	CONDITIONNEMENT PACKING	LIV/PCB
EUROWALLET®	35305	190 x 100 x 70	PVC/Nylon/PA 	Vrac / Bulk	1/25
PRÉSENTOIR EUROWALLET® X 12	35305-12 RT	400 x 300 x 200	Carton 	Présentoir / Display	1/1

COMPTEUSE DE PIÈCES / COINS COUNTERS

CP200

Compteuse/trieuse de pièces € double fonction valorisation - Dual valorisation function Euro coin counter/sorter

Valorisation € du montant total compté + valorisation € par unité de valeur (détail nombre de pièces par dénomination valeur) - Total amount € counted + value € & quantity per coin denomination

3 modes de comptage : Tri/Comptage/Mise en lot (mode idéal pour la préparation de rouleaux de pièces, dépôts bancaires & fonds de tiroir-caisse)

Sort/Count/Batch (best way to prepare coin rolls, bank deposits & cash-drawer counting modes)

Fonction arrêt automatique programmable - Programmable automatic stop function

Arrêt automatique lorsque le casier est plein - Automatic stop when full coin tray

Capacité de la trémie : 900-1100 pièces - Hopper capacity : 900-1100 coins

Mode mise en veille - Power saving mode

Affichage écran LCD - LCD display screen

Poignée de transport - Carry handle

FA62335 : fournie avec 8 casiers - FA62335 : 8 coin trays supplied

Mise en lot



Batch mode

Panneau de commande



Control panel

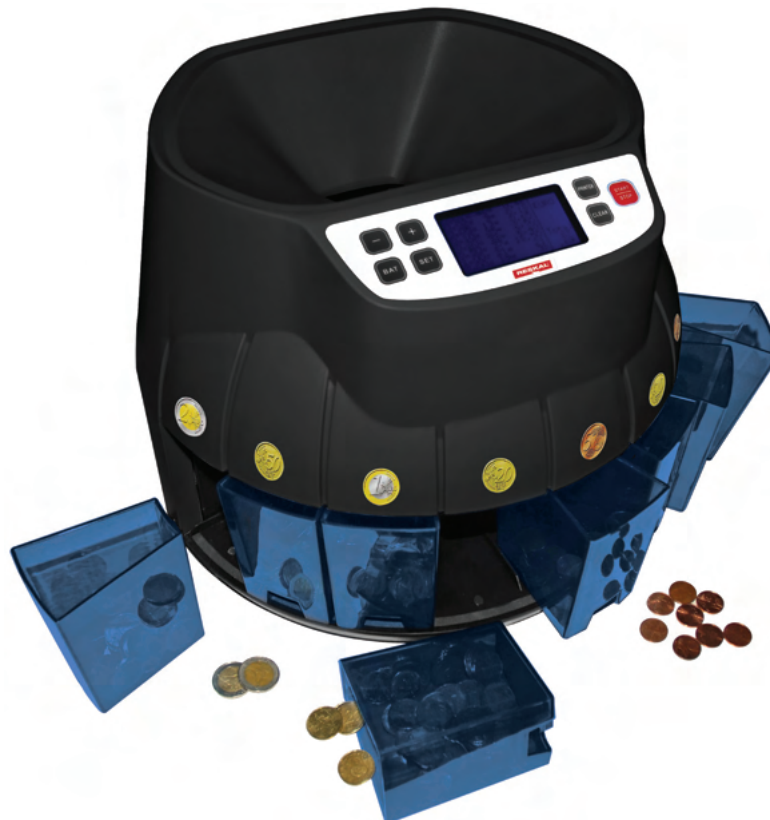

MODÈLE MODEL	REF.	DIM. (H X L X P MM)	CARACTÉRISTIQUES SPECIFICATIONS	VITESSE DE COMPTAGE (pcs/min) COUNTING SPEED (coins/min)	CONDITIONNEMENT PACKING	LIV/PCB
CP200	FA62335	360 x 345 x 280	 	315/345	Boîte / Box	1/2

SÉCURISER - DÉTECTER

Secure - Detect

COMPTEUSES DE BILLETS / BANKNOTE COUNTERS



LD80

Compteur de billets avec détection automatique - Banknotes counter with automatic self-checking detection

Devises : Euro, GBP - Currencies : Euro, GBP

Modes de détection : UV, MG1/MG2, IR, SIZE (2D) - Detection methods : UV, MG1/MG2, IR, SIZE (2D)

Niveaux de vérification : 4 - Authentication levels : 4

Détection des doubles, demi-billets & suites - Double, half-notes detection & chain-note checking

3 modes de comptage : Automatique, Mise en lot & Addition - 3 counting modes : Automatic, Preset (batch) & Adding

Compte du nombre de passage - Counting the number of passages

Fonction démarrage & arrêt automatique - Auto start & stop function

Capacité du réceptacle : jusqu'à 300 billets - Hopper capacity : 300 banknotes

Chargement des billets à l'arrière - Banknotes backloading mechanism

Poignée de transport - Carry handle

Écran supplémentaire déporté - Additional remote screen

MODÈLE MODEL	REF.	DIM. (H X L X P MM)	CARACTÉRISTIQUES SPECIFICATIONS	VITESSE DE COMPTAGE (billets/min) COUNTING SPEED (banknotes/min)	CONDITIONNEMENT PACKING	LIV/PCB
LD80	FA62326	330 x 270 x 200		1000	Boîte / Box	1/2

LD90

Compteur de billets avec détection automatique - Banknotes counter with automatic self-checking detection

Devises : Euro, CHF, GBP, USD - Currencies : Euro, CHF, GBP, USD

Modes de détection : UV, MG, MT, IR, WM, SIZE (3D) - Detection methods : UV, MG, MT, IR, WM, SIZE (3D)

Niveaux de vérification : 5 - Authentication levels : 5

Détection des doubles, demi-billets & suites - Double, half-notes detection & chain-note checking

4 modes de comptage : Automatique (avec/sans détection), Mise en lot & Addition - 4 counting modes : Automatic (free sheet counting with/without detection), Preset (batch) & Adding

Valorisation : montant total calculé par unité de valeur - Valuation : total amount calculated per value unit

Comptage de la somme totale : détail + valeur totale - Total sum count: detail + total value

Fonction démarrage & arrêt automatique - Auto start & stop function

Vitesse de comptage \geq 1000 billets/min - Counting speed \geq 1000 banknotes/min

Capacité du réceptacle : jusqu'à 300 billets - Hopper capacity : 300 banknotes

Chargement des billets à l'arrière - Banknotes backloading mechanism

Panneau de commande tactile 6 touches - Touch control panel with 6 button operation

Affichage écran LCD - LCD display screen



Mise à jour
Update
www.reskal.com

MODÈLE MODEL	REF.	DIM. (H X L X P MM)	CARACTÉRISTIQUES SPECIFICATIONS	VITESSE DE COMPTAGE (billets/min) COUNTING SPEED (banknotes/min)	CONDITIONNEMENT PACKING	LIV/PCB
LD90	FA62330 CB	300 x 250 x 180		1000	Boîte / Box	1/2

DÉTECTION / DETECTION

Marque jaune : billet authentique
Yellow mark : genuine banknote

Marque noire : billet suspecté faux
Dark mark : suspected banknote



STYLO DÉTECTEUR

Stylo détecteur de faux billets - Counterfeit detector pen
Mode de détection : réaction chimique (encre par rapport à la qualité du papier fiduciaire à base de coton) - Detection method : chemical reaction (ink regarding cotton-base banknote paper quality)

Niveaux de vérification : 1 - Authentication levels : 1

Authentification instantanée, détection directe(1) - Immediate verification, direct detection(1)

Uniquement pour billet en papier - Only for paper banknote



(1) Il est recommandé d'utiliser un détecteur validé BCE pour confirmer le résultat. - It is recommended to use a detector validated by ECB to confirm the result

MODÈLE MODEL	REF.	DIM. (H X L X P MM)	CARACTÉRISTIQUES SPECIFICATIONS	DEVICES CURRENCIES	CONDITIONNEMENT PACKING	LIV/PCB
STYLO DÉTECTEUR DETECTOR PEN	FA62323	Ø 15 x 134		Toutes devises All currencies	LS / Pegboardable	10/500



LD25

Détecteur de faux : billets & documents - Counterfeit detector : banknotes & documents

Technique de détection par transparence ou reflet - Detection technic by transparency or reflection

Modes de détection : UV, lampe blanche 16W - Detection methods : UV, white lamp 16W

Niveaux de vérification : 2 - Authentication levels : 2

Convient pour vérifier les caractéristiques de sécurité UV des pièces d'identité (cartes d'identité, passeports), permis de conduire, cartes de crédit ... - Suitable for checking UV security features of ID documents (ID cards, passports), driving licences, credit cards ...

Lumière blanche pour vérifier filigranes, fils métalliques ... - White light to identify watermarks, metallic threads ...

Alimentation sur secteur - Power supply

FA62074 : lampe blanche 16W - FA62074 : white lamp 16W

FA62075 : lampe UV bleu/violet 13W - FA62075 : blue/purple UV lamp 13W



MODÈLE MODEL	REF.	DIM. (H X L X P MM)	CARACTÉRISTIQUES SPECIFICATIONS	DEVICES CURRENCIES	CONDITIONNEMENT PACKING	LIV/PCB
LD25	FA62071	135 x 278 x 120		Toutes devises All currencies	Boîte / Box	1/6
LAMPE BLANCHE WHITE LAMP	FA62074	Puissance/Power 16 W		-	Boîte / Box	1/100
LAMPE UV UV LAMP	FA62075	Puissance/Power 13 W		-	Boîte / Box	1/100



SÉCURISER - DÉTECTER

Secure - Detect



LD500

Détecteur automatique de faux billets - Automatic counterfeit detector
 2 devises par défaut : Euro, CHF - 2 default currencies : Euro, CHF
 Sélection de la devise par bouton - Select currency by button
 Mode de détection : IR, MG, MT (fil métallique), SIZE (2D) - Detection methods : IR; MG, MT (metal wire), SIZE (2D)
 Niveaux de vérification : 4 - Authentication levels : 4
 2 modes de comptage : Automatique/Addition - Automatic/Adding dual counting modes
 Insertion aléatoire des billets - Insertion in any direction
 Expulsion des billets par l'avant ou l'arrière - Banknotes exit direction from the front or the rear
 Alimentation sur secteur - Power supply
 Affichage écran LED - LED display screen

Mise à jour
 Update
www.reskal.com

MODÈLE MODEL	REF.	DIM. (H X L X P MM)	CARACTÉRISTIQUES SPECIFICATIONS	DEVISES CURRENCIES	CONDITIONNEMENT PACKING	UV/PCB
LD500	FA62440	220 x 120 x 75		€ - CHF	Boîte / Box	1/12
CORDON ALIMENTATION POWER CABLE (LD500)	12.7228	-		-	Vrac / Bulk	1/1
CÂBLE DE MISE À JOUR UPDATE CABLE	9996.113	-		-	Vrac / Bulk	1/1

LD520 - LD520B

Détecteur automatique de faux billets - Automatic counterfeit detector
 3 devises par défaut : Euro, GBP £, US \$ - 3 default currencies : Euro, GBP £, US \$
 Détection automatique de la devise - Automatic currency detection
 Mode de détection : UV, IR, MG, Optique - Detection methods : UV, IR, MG, Optical picture
 Niveaux de vérification : 4 - Authentication levels : 4
 Mode de comptage Automatique : valeur unitaire du billet authentifié & montant total valorisé - Automatic counting mode : unit value banknotes checked & total amount counted (value)
 Expulsion des billets par l'avant ou l'arrière - Banknotes exit direction from the front or the rear
 Alimentation sur secteur ou batterie - Power or battery supply
 Affichage écran LED - LED display screen



Mise à jour
 Update
www.reskal.com

MODÈLE MODEL	REF.	DIM. (H X L X P MM)	CARACTÉRISTIQUES SPECIFICATIONS	DEVISES CURRENCIES	CONDITIONNEMENT PACKING	UV/PCB
LD520	FA62460	140 x 125 x 80		€ - GBP £ - US \$	Boîte / Box	1/12
LD520B	FA62455	140 x 125 x 80		€ - GBP £ - US \$	Boîte / Box	1/12
CORDON ALIMENTATION POWER CABLE (LD520-LD520B)	9996.184	-		-	Vrac / Bulk	1/1
HOUSSE / POUCH (LD520/LD520B)	9996.224	-		-	-	1/50

LD550 - LD550B

Détecteur automatique de faux billets - Automatic counterfeit detector
 2 devises par défaut : Euro, CHF - 2 default currencies : Euro, CHF
 Détection automatique de la devise - Automatic currency detection
 Modes de détection : IR, UV avec capteurs LED, MG, MT (fil métallique), WM (filigranes) - Detection methods : IR, UV with LED sensors, MG, MT (metal wire), WM (watermarks)
 Niveaux de vérification : 5 - Authentication levels : 5
 Modes de comptage Automatique : nombre total de billets authentifiés & montant total valorisé - Automatic counting mode : total banknotes checked (quantity) & total amount counted (value)
 Insertion aléatoire des billets - Random insertion of banknotes
 Expulsion des billets par l'avant ou l'arrière - Banknotes exit direction from the front or the rear
 Alimentation sur secteur ou batterie selon modèle - Power or battery supply depending on model
 Affichage écran LED - LED display screen



Mise à jour
 Update
www.reskal.com



MODÈLE MODEL	REF.	DIM. (H X L X P MM)	CARACTÉRISTIQUES SPECIFICATIONS	DEVISES CURRENCIES	CONDITIONNEMENT PACKING	UV/PCB
LD550	FA62441	155 x 137 x 82		€ - CHF	Boîte / Box	1/12
LD550B	FA62523	155 x 137 x 82		€ - CHF	Boîte / Box	1/12
BATTERIE / BATTERY (LD550B)	9996.166	-		-	LS / Pegboardable	1/1
CORDON ALIMENTATION POWER CABLE (LD550)	9996.184	-		-	Vrac / Bulk	1/1
CÂBLE DE MISE À JOUR UPDATE CABLE	9996.114	-		-	Vrac / Bulk	1/1
HOUSSE / POUCH (LD550/LD550B)	9996.224	-		-	Vrac / Bulk	1/50



SÉCURISER - DÉTECTER

Secure - Detect

ARMOIRES À CLÉS / KEYS CABINETS

KC20 - 40 - 60 - 80 - 140

Corps métal (acier embouti) - Metal frame (pressed steel)

Suspensions fixes avec numérotation - Fixed suspensions with numbering

Ouverture/fermeture par serrure à clé (2 clés fournies) - Opening/closing by key lock (2 keys supplied)

1 volet intérieur (version 80 & 140 clés) - 1 inner flap (model 80 & 140 keys)

Équipé de porte-clés en coloris assortis - Assorted colors key rings supplied



MODÈLE MODEL	REF.	DIM. (H X L X P MM)	CARACTÉRISTIQUES SPECIFICATIONS	CAPACITÉ CAPACITY	ACCESSOIRES ACCESSORIES	CONDITIONNEMENT PACKING	LIV/PCB
KC20	FA62158	200 x 160 x 80	Métal / Metal	20		Vrac / Bulk	1/10
KC40	FA62164	200 x 160 x 80	Métal / Metal	40		Vrac / Bulk	1/6
KC60	FA62200	370 x 280 x 85	Métal / Metal	60		Vrac / Bulk	1/6
KC80	FA62203	370 x 280 x 60	Métal / Metal	80		Vrac / Bulk	1/4
KC140	FA62206	370 x 280 x 80	Métal / Metal	140		Vrac / Bulk	1/4

AR020 - 048



Corps métal (acier embouti) - Metal frame (pressed steel)

Suspensions fixes avec numérotation - Fixed suspensions with numbering

Ouverture/fermeture par serrure à clé (2 clés fournies) - Opening/closing by key lock (2 keys supplied)



MODÈLE MODEL	REF.	DIM. (H X L X P MM)	CARACTÉRISTIQUES SPECIFICATIONS	CAPACITÉ CAPACITY	ACCESSOIRES ACCESSORIES	CONDITIONNEMENT PACKING	LIV/PCB
AR020	27201	200 x 160 x 80	Métal / Metal	20		Vrac / Bulk	1/6
AR048	27401	300 x 240 x 80	Métal / Metal	48		Vrac / Bulk	1/6

AC20 - 40 - 45 - 48 - 54

Corps métal poli (acier embouti) - Polished metal frame (pressed steel)



Suspensions fixes avec étiquettes autocollantes numérotées - Fixed suspensions with numbered self-adhesive labels

Ouverture/fermeture par serrure à clé (2 clés fournies) - Opening/closing by key lock (2 keys supplied)

1 volet intérieur (à partir de 40 clés) - 1 inner flap (from 40 keys)

Équipé de porte-clés en coloris assortis - Assorted colors key rings supplied



MODÈLE MODEL	REF.	DIM. (H X L X P MM)	CARACTÉRISTIQUES SPECIFICATIONS	CAPACITÉ CAPACITY	ACCESSOIRES ACCESSORIES	CONDITIONNEMENT PACKING	UV/PCB
AC20BEI	FA62820	200 x 160 x 60	Métal / Metal  	20	 	Vrac / Bulk	1/10
AC20BLE	FA62821	200 x 160 x 60	Métal / Metal  	20	 	Vrac / Bulk	1/10
AC20N	FA62822	200 x 160 x 60	Métal / Metal  	20	 	Vrac / Bulk	1/10
AC20R	FA62823	200 x 160 x 60	Métal / Metal  	20	 	Vrac / Bulk	1/10
AC40BEI	FA62840	200 x 160 x 80	Métal / Metal  	40	 	Vrac / Bulk	1/6
AC40BLE	FA62841*	200 x 160 x 80	Métal / Metal  	40	 	Vrac / Bulk	1/6
AC40N	FA62842	200 x 160 x 80	Métal / Metal  	40	 	Vrac / Bulk	1/6
AC45	FA62854*	300 x 240 x 60	Métal / Metal  	45	 	Vrac / Bulk	1/10
AC48BEI	FA62850	250 x 180 x 80	Métal / Metal  	48	 	Vrac / Bulk	1/6
AC48N	FA62852	250 x 180 x 80	Métal / Metal  	48	 	Vrac / Bulk	1/6
AC48R	FA62853*	250 x 180 x 80	Métal / Metal  	48	 	Vrac / Bulk	1/6
AC54BEI	FA62199	300 x 240 x 60	Métal / Metal  	54	 	Vrac / Bulk	1/6

* Jusqu'à épuisement des stocks

SÉCURISER - DÉTECTER

Secure - Detect

BOÎTES À CLÉS MURALE - Wall key boxes

Ouverture à combinaison manuelle
Opening by digit combination



Corps 2 pièces en fonte - Body made of cast iron
Ouverture/fermeture par combinaison manuelle à 3 chiffres - Opening/closing by 3 digits combination lock
Suspension fixe - Fixed suspension
Capacité : 3/4 clés - Capacity : 3/4 keys

Ouverture/fermeture par combinaison manuelle à 4 chiffres - Opening/closing by 4 digits combination lock
Anse amovible - Removable handle
Utilisation intérieure/extérieure - Inside/Outside use
2 fixations possibles - 2 possible fixings :
. Fixation murale (visserie incluse) - Wall mounting (hardware included)
. Fixation par anse - Fixed suspensions
Capacité : 6 clés - Capacity : 6 keys



















REF.	DIM. (H X L X P MM)	CARACTÉRISTIQUES SPECIFICATIONS	ACCESSOIRES ACCESSORIES	CONDITIONNEMENT PACKING	LIV/PCB
FA62551	147 x 102 x 55	Fonte Cast iron	 	LS / Pegboardable	1/20

REF.	DIM. (H X L X P MM)	CARACTÉRISTIQUES SPECIFICATIONS	ACCESSOIRES ACCESSORIES	CONDITIONNEMENT PACKING	LIV/PCB
FA62902	176 x 86 x 42	Alliage d'aluminium Aluminium alloy	 	LS / Pegboardable	1/20

ARCOMBI 15 - 36 - 45 - 120

Corps métal (acier embouti) - Metal frame (pressed steel)
Suspensions fixes avec numérotation - Fixed suspensions with numbering
Ouverture/fermeture par serrure à combinaison manuelle à 3 chiffres - Opening/closing by 3 digits combination lock
1 code utilisateur - 1 user code
1 volet intérieur (version 120 clés) - 1 inner flap (model 120 keys)



MODÈLE MODEL	REF.	DIM. (H X L X P MM)	CARACTÉRISTIQUES SPECIFICATIONS	CAPACITÉ CAPACITY	ACCESSOIRES ACCESSORIES	CONDITIONNEMENT PACKING	LIV/PCB
ARCOMBI 15	27204	200 x 160 x 90	Métal / Metal   	15		Vrac / Bulk	1/6
ARCOMBI 36	28305	300 x 240 x 80	Métal / Metal  	36		Vrac / Bulk	1/10
ARCOMBI 36	FA62836	300 x 240 x 80	Métal / Metal  	36	 	Vrac / Bulk	1/6
ARCOMBI 45	27404	300 x 240 x 90	Métal / Metal   	45		Vrac / Bulk	1/6
ARCOMBI 120	27504	370 x 280 x 90	Métal / Metal   	120		Vrac / Bulk	1/6

EC 42 - 68 - 105 - 148 - 203 - 302



Corps métal (acier plié & soudé) - Metal frame (bent & welded steel)

Suspensions amovibles, réglables sur crémaillères avec numérotation - Adjustable & removable suspensions fixed on racks with numbering

Ouverture/fermeture par serrure à clé (2 clés numérotées fournies) - Opening/closing by key lock (2 keys supplied)

























1 volet intérieur (version 148 clés) - 1 inner flap (model 148 keys)

2 volets intérieurs (version 203 & 302 clés) - 2 inner flaps (model 203 & 302 keys)

Répertoire incorporé - Integrated directory

Équipé de porte-clés en coloris assortis - Assorted colors key rings supplied



MODÈLE MODEL	REF.	DIM. (H X L X P MM)	CARACTÉRISTIQUES SPECIFICATIONS	CAPACITÉ CAPACITY	ACCESSOIRES ACCESSORIES	CONDITIONNEMENT PACKING	LIV/PCB
EC42	24402	290 x 215 x 60	Métal / Metal  	42	 	Boîte / Box	1/6
EC68	24403	390 x 300 x 60	Métal / Metal  	68	 	Boîte / Box	1/6
EC105	24404	475 x 350 x 60	Métal / Metal  	105	 	Boîte / Box	1/6
EC148	24411	390 x 300 x 120	Métal / Metal  	148	 	Boîte / Box	1/3
EC203	24412	475 x 350 x 120	Métal / Metal  	203	 	Boîte / Box	1/3
EC302	24413	490 x 350 x 180	Métal / Metal  	302	 	Boîte / Box	1/1

SÉCURISER - DÉTECTER

Secure - Detect

STAR EASY 60 - 100 - 150 - 200 - 250 - 400



Corps métal (acier plié & soudé) - Metal frame (bent & welded & steel)

Suspensions amovibles, réglables sur crémaillères avec numérotation - Adjustable & removable suspensions fixed on racks with numbering
Ouverture/fermeture par serrure à clé (2 clés numérotées fournies) - Opening/closing by key lock (2 keys supplied)

1 volet intérieur (version 400 clés) - 1 inner flap (model 400 keys)

Répertoire incorporé - Integrated directory



MODÈLE MODEL	REF.	DIM. (H X L X P MM)	CARACTÉRISTIQUES SPECIFICATIONS	CAPACITÉ CAPACITY	ACCESSOIRES ACCESSORIES	CONDITIONNEMENT PACKING	LIV/PCB
STAR EASY 60	IM21761	480 x 380 x 90	Métal / Metal  	60		Boîte / Box	1/1
STAR EASY 100	IM21763	480 x 580 x 90	Métal / Metal  	100		Boîte / Box	1/1
STAR EASY 150	IM21764	680 x 580 x 90	Métal / Metal  	150		Boîte / Box	1/1
STAR EASY 200	IM80026	680 x 580 x 120	Métal / Metal  	200		Boîte / Box	1/1
STAR EASY 250	IM80027	680 x 580 x 138	Métal / Metal  	250		Boîte / Box	1/1
STAR EASY 400	IM80029	680 x 580 x 140	Métal / Metal  	400		Boîte / Box	1/1







* Jusqu'à épaisseur des stocks

STAR ELEC 20 - 40 - 60



Corps métal (acier plié & soudé) - Metal frame (bent & welded & steel)
 Suspensions fixes avec numérotation - Fixed suspensions with numbering
 Ouverture/fermeture par serrure électronique - Opening/closing by electronic lock
 1 code utilisateur (combinaison numérique de 4 à 6 chiffres) - 1 user code (combination of 4 to 6 digits)
 Répertoire incorporé - Integrated directory
 Capacité : 20 à 60 clés - Capacity : 20 to 60 keys
 Fonction «mémorisation» - Function «storage»



MODÈLE MODEL	REF.	DIM. (H X L X P MM)	CARACTÉRISTIQUES SPECIFICATIONS	CAPACITÉ CAPACITY	ACCESSOIRES ACCESSORIES	CONDITIONNEMENT PACKING	UV/PCB
STAR ELEC 20	IM21771	300 x 250 x 80	Métal / Metal 	20		Vrac / Bulk	1/1
STAR ELEC 40	IM21772	400 x 300 x 80	Métal / Metal 	40		Vrac / Bulk	1/1
STAR ELEC 60	IM21773	450 x 350 x 80	Métal / Metal 	60		Vrac / Bulk	1/1

SÉCURISER - DÉTECTER

Secure - Detect

PORTE-CLÉS / KEYS TAGS

PORTE-CLÉS PE



Porte-clés corps plastique PE couleur
Colored PE plastic frame keys tags

Anneau de suspension chromé

Chrome plated suspension ring

étiquette papier interchangeable & fenêtre de protection - Interchangeable paper label & window protection



MODÈLE MODEL	REF.	DIM. (H X L X P MM)	CARACTÉRISTIQUES SPECIFICATIONS	ACCESSOIRES ACCESSORIES	CONDITIONNEMENT PACKING	LIV/PCB
	FA62170	51 x 22	PE 20 PCS		LS / Pegboardable	10/100
	UPI00275 (assort)	52 x 22	PE 20 PCS		Vrac / Bulk	1/1
	UPI00269 (assort)	52 x 22	PE 100 PCS		Vrac / Bulk	1/1
	UPI00252	52 x 22	PE 100 PCS		Vrac / Bulk	1/1
	UPI00253	52 x 22	PE 100 PCS		Vrac / Bulk	1/1
	UPI00254	52 x 22	PE 100 PCS		Vrac / Bulk	1/1
	UPI00255	52 x 22	PE 100 PCS		Vrac / Bulk	1/1
	UPI00256	52 x 22	PE 100 PCS		Vrac / Bulk	1/1
	UPI00281	52 x 22	PE 100 PCS		Vrac / Bulk	1/1
	UPI00257 (assort)	52 x 22	PE 100 PCS		Vrac / Bulk	1/1
	UPI00258	52 x 22	PE 20 PCS		Vrac / Bulk	1/1
	UPI00259	52 x 22	PE 20 PCS		Vrac / Bulk	1/1
	UPI00260	52 x 22	PE 20 PCS		Vrac / Bulk	1/1
	UPI00261	52 x 22	PE 20 PCS		Vrac / Bulk	1/1
	UPI00262	52 x 22	PE 20 PCS		Vrac / Bulk	1/1
	UPI00282	52 x 22	PE 20 PCS		Vrac / Bulk	1/1
	UPI00263 (assort)	52 x 22	PE 20 PCS		Vrac / Bulk	1/1
	900021		PE 5 PCS		LS / Pegboardable	1/500

CLIC FLEX KEY®



Porte-clés magnétique (néodyme)
corps plastique rigide couleur - Magnetic
(neodymium) keys tag & colored rigid plastic
frame

Anneau de suspension chromé & anneau
caoutchouc - Chrome plated suspension ring
& rubber ring

étiquette papier interchangeable &
fenêtre de protection - Interchangeable
paper label & window protection



MODÈLE MODEL	REF.	DIM. (H X L X P MM)	CARACTÉRISTIQUES SPECIFICATIONS	ACCESSOIRES ACCESSORIES	CONDITIONNEMENT PACKING	LIV/PCB
CLIC FLEX KEY®	UPI00410* (assort)	60 x 36	ABS 6 PCS		LS / Pegboardable	1/20
	UPI00425* (assort)	60 x 36	ABS 30 PCS		Présentoir / Display	1/20

* Jusqu'à épuisement des stocks

CADENAS / PADLOCKS

Ne convient pas aux collectivités
Not suitable for collectivities



CADENAS LAITON À CLÉS

Brass padlock with keys

Anse chromée - Chrome plated shackle

Ouverture/fermeture par serrure à clé (3 clés fournies) - Opening/closing by key lock (3 keys supplied)

MODÈLE MODEL	REF.	CARACTÉRISTIQUES SPECIFICATIONS	CONDITIONNEMENT PACKING	LIV/PCB
30 MM	SCD300072	Laiton / Brass	LS / Pegboardable	1/144
	SCD300171	Laiton / Brass	Vrac / Bulk	12/300
40 MM	SCD400072	Laiton / Brass	LS / Pegboardable	1/144
	SCD400271	Laiton / Brass	Vrac / Bulk	12/180

CADENAS LAITON À CLÉS - HAUTE QUALITÉ

Brass padlock with keys- High quality

Anse chromée - Chrome plated shackle

Ouverture/fermeture par serrure à clé (clés fournies) - Opening/closing by key lock (keys supplied)

Cadenas et anse plus épais - Thicker padlock and handle

Clé forte - Strong key

Petit trou sous le cadenas : permet d'éliminer l'humidité et donc d'éviter le gel pour une utilisation en extérieur - Small hole under the padlock : eliminates moisture and prevents freezing for outdoor use

Double ancrage (seulement sur modèle SCD400171) - Double anchoring (model only SCD400171)

MODÈLE MODEL	REF.	CARACTÉRISTIQUES SPECIFICATIONS	CONDITIONNEMENT PACKING	LIV/PCB
30 MM	SCD300372	Laiton / Brass	LS / Pegboardable	6/72
40 MM	SCD400171	Laiton / Brass	Vrac / Bulk	12/120



CADENAS LAITON À CLÉS - ANSE HAUTE

Brass padlock with keys- High shackle

Anse acier trempé chromé - Chrome plated hardened steel shackle

Ouverture/fermeture par serrure à clé (clés fournies) - Opening/closing by key lock (keys supplied)

Cadenas et anse plus épais - Thicker padlock and handle

Mécanisme 4 ancrages - 4 safety pins cylinder

MODÈLE MODEL	REF.	CARACTÉRISTIQUES SPECIFICATIONS	CONDITIONNEMENT PACKING	LIV/PCB
40 MM	SCD400472	Laiton / Brass	LS / Pegboardable	6/72

SÉCURISER - DÉTECTER

Secure - Detect



CADENAS EXTÉRIEUR Outdoor padlock











Anse acier laqué - Lacquered steel shackle
Ouverture/fermeture par serrure à clé (clés fournies) - Opening/closing by key lock (keys supplied)
Corps large et épais - Wide and thick body
Revêtement PVC - PVC covering
Mécanisme 4 ancrages - 4 safety pins cylinder
Protection de la serrure - Lock protection

MODÈLE MODEL	REF.	CARACTÉRISTIQUES SPECIFICATIONS	CONDITIONNEMENT PACKING	LIV/PCB
40 MM	SCD490072	Laiton / Brass  	LS / Pegboardable	6/72

CADENAS À COMBINAISON Combination padlock

Cadenas acier ou laiton à combinaison - Metal or brass combination padlock
Anse acier chromée - Steel chromed shackle
Ouverture/fermeture par combinaison à 3 chiffres personnalisable - Opening/closing by customisable 3 digits combination code



MODÈLE MODEL	REF.	CARACTÉRISTIQUES SPECIFICATIONS	CONDITIONNEMENT PACKING	LIV/PCB
	SCD210072	Laiton / Brass  	LS / Pegboardable	1/144
20 MM	SCD220071	Acier / Steel  	Vrac / Bulk	1/720
	SCD220372	Acier / Steel  	LS / Pegboardable	1/144
30 MM	SCD310072	Laiton / Brass  	LS / Pegboardable	1/72
32 MM	SCD620072	Acier / Steel  	LS / Pegboardable	10/120

CADENAS À CODE Digital padlock

Cadenas alliage 35mm 8 chiffres - Alloy padlock 35 mm 8 digits
Code 4 chiffres non modifiable - Not customisable 4 digits combination code



MODÈLE MODEL	REF.	CARACTÉRISTIQUES SPECIFICATIONS	CONDITIONNEMENT PACKING	LIV/PCB
DIGITAL	SCD630072	Acier / Steel  	LS / Pegboardable	12/120





CADENAS À COMBINAISON Combination padlock

Ouverture/fermeture par combinaison à 3 ou 4 chiffres personnalisable

Opening/closing by customisable 3 or 4 digits combination code

SCD340272 : anse câble - Cable shackle

SCD340372 : anse chromée - Chromed steel shackle

MODÈLE MODEL	REF.	CARACTÉRISTIQUES SPECIFICATIONS	CONDITIONNEMENT PACKING	UV/PCB
35 mm	SCD340272	Alliage de zinc / Zinc alloy Acier / Steel	LS / Pegboardable	6/72
30 mm	SCD340372	Polycarbonate Acier / Steel	LS / Pegboardable	6/72



Transportation
Security
Administration

Travel Sentry® a mis au point un système de verrouillage qui est «accepté et reconnu» par la Transportation Security Administration (TSA) et d'autres agences de sécurité, et qui leur permet, à l'aide d'outils et de codes spéciaux, d'ouvrir et de reverrouiller les serrures. Les outils fournis par Travel Sentry se trouvent à chaque point de contrôle des bagages dans tous les aéroports contrôlés par la TSA.

Travel Sentry® Approved est un système de sécurité global qui permet de verrouiller les bagages, tout en permettant aux agents de sécurité de l'aéroport d'ouvrir les bagages pour une inspection physique lorsque cela est nécessaire sans avoir besoin de couper/casser le cadenas ou de gêner le passager.

Travel Sentry® developed a lock system that is «accepted and recognized» by the Transportation Security Administration (TSA) and other security agencies, and allows them using special tools and codes, to open and re-lock locks. The tools provided by Travel Sentry are at every luggage screening checkpoint at all airports controlled by the TSA. Travel Sentry® Approved is a global security system that allows luggage for physical inspection when required without the need to cut off/break the lock or inconvenience to the passenger.



CADENAS À EMPREINTES DIGITALES + CADENAS CONNECTÉS



CADENAS ÉLECTRONIQUE SANS FIL NFC NFC electronic padlock

Cadenas intelligent sans fil et sans batterie - Battery-free, wireless smart padlock

Avec technologie NFC, nécessite un téléphone compatible - With NFC technology, require an NFC compatible phone

Étanche IPX5 - Waterproof IPX5

Méthode de déverrouillage : APP bracelet NFC - Unlocking method : APP NFC bracelet

Ouverture : 2 à 5 secondes - Opening time: 2 to 5 secondes

T°C de fonctionnement : -20 °C à 65 °C - Operating T°C: -20 °C to 65 °C

Système d'exploitation : Android 9.0 / IOS 8.0 ou supérieur - Operating system: Android 9.0 or IOS 8.0 above

REF.	TAILLE SIZE	CARACTÉRISTIQUES SPECIFICATIONS	CONDITIONNEMENT PACKING	UV/PCB
SCD860072	85 x 50 x 19 mm	Alliage de zinc Zinc alloy	LS / Pegboardable	1/50

SÉCURISER - DÉTECTER

Secure - Detect



Tuya Smart



Smart Life

CADENAS À EMPREINTE DIGITALE ET BLUETOOTH

Connected and fingerprint padlock

Cadenas connecté par Bluetooth - Bluetooth-connected padlock
Ouverture par empreinte digitale ou avec application mobile - Opening with fingerprint or with mobile application

Capacité de mémoire : 10 empreintes - 10 fingerprint memory capacity
Capacité de la batterie : 150 mAh 3,7V - Battery capacity: 150 mAh 3,7V
Usage intérieur / extérieur (-10°C/+45°C) - Indoor/outdoor use (-10°C/+45°C)
Connectez le cadenas à l'application Tuya Smart* ou à l'application Smart Life* pour enregistrer les empreintes, déverrouiller le cadenas, vérifier les dernières activités, ... - Connect the padlock to the Tuya Smart* app or Smart Life* app to register fingerprints, unlock the padlock, check recent activity, etc.

REF.	TAILLE SIZE	CARACTÉRISTIQUES SPECIFICATIONS	CONDITIONNEMENT PACKING	UV/PCB
SCD760172	76 x 46 x 13 mm	Alliage de zinc Zinc alloy	LS / Pegboardable	1/50

* Applications gratuites, disponibles sur App Store et Google Store.
Free applications, available on App Store and Google Store.



CADENAS À EMPREINTE DIGITALE

Fingerprint padlock

Ouverture par empreinte digitale - With fingerprint opening
Capacité de la mémoire : 10 empreintes - Memory capacity: 10 fingerprints
Ouverture : moins de 0,5 secondes - Opening time: less than 0.5 secondes
Capacité de la batterie : 110 mAh 3.7V - Battery capacity: 110 mAh 3.7V
Capacité de veille max : 6 mois - Max standby time: 6 months
Temps de charge : 1 à 2h - Charging time: 1-2h
Recharge par USB - Charge by USB

REF.	TAILLE SIZE	CARACTÉRISTIQUES SPECIFICATIONS	CONDITIONNEMENT PACKING	UV/PCB
SCD760072	24 x 70 mm	Alliage de zinc Zinc alloy	LS / Pegboardable	1/120

UN COUP DE POUCE ?



CÂBLE ANTIVOL BIOMÉTRIQUE À EMPREINTE DIGITALE

Biometric fingerprint anti-theft cable

Mémoire : 50 empreintes - Memory: 50 prints
Capacité de la batterie : 250 mAh - Battery capacity: 250 mAh
IPP66 - IPP66
Longueur du câble : 1,50 m - Cable length: 1.50 m
Épaisseur du câble : 12 mm - Cable thickness: 12 mm
Alliage de zinc et câble acier recouvert - Zinc alloy and covered steel cable

REF.	TAILLE SIZE	CARACTÉRISTIQUES SPECIFICATIONS	CONDITIONNEMENT PACKING	UV/PCB
SCD760272	1,50 m	Alliage de zinc & câble acier Zinc alloy & steel cable	LS / Pegboardable	1/25



L'union fait la force !



On vous présente

LA WONDAY FAMILY





Wonday[®] FAMILY



INDEX ALPHABÉTIQUE

Alphabetical index



A

Accessoires billets & monnaie	265
Accessoires d'ardoises	76 > 77
Accessoires de bureau	176 > 178
Accessoires électriques	188 > 189
Accessoires tableaux	159
Adhésifs	203
Agrafes	45
Agrafeuse électrique	39
Agrafeuses	40 > 43
Agrafeuses grande capacité	39 > 40
Aides à écrire	123
Aimants	64 > 68
Anneaux brisés	59
Ardoises	73 > 75
Armoires à clés	272 > 277
Armoires à fusils	259
Armoires à pharmacie	236
Armoires fortes	258
Attaches croisées	59
Attaches parisiennes	52

B

Badges & accessoires	162 > 163
Balances	178
Bâtons de gouache	127
Blouses blanches	129
Boîte aux lettres	185
Boîtes à clés	274
BOLLÉ SAFETY	239
Boussoles	112
Bracelets caoutchouc	53 > 55
Brosses tableaux	160 > 161

C

Cadenas	279 > 282
Cadenas connectés	281 > 282
Cadenas TSA	281
Caisses à monnaies	260 > 262
Calculatrices TRULY	103
Cartouches d'encre	121
Cendriers	185
Cercluse à mains	203
Chariots	221 > 227
Chemises/pochettes/classseurs	166 > 169
Chronomètre	115
Ciseaux bureau & maison	19 > 27

Ciseaux cranteurs	145
Ciseaux école	28 > 32
Coffre voyage	247
Coffres à valeur assurable	252 > 257
Coffres de dépôt	246
Coffres de sécurité	242 > 245
Coffres hôtel	247
Coffres ignifuges 1h	248 > 251
Coffret de secours	237
Colles	69
Compas	78 > 83
Compteuses de billets	268
Compteuses de pièces	267
Cônes et jalons	114
Corne de brume	116
Correcteurs	70
Craies	76
Craies de trottoir	137
Crayons de couleur	125 > 126
Crayons graphite	123
Cutters & lames	192 > 196
Cutters de précision	142
Cutters lames céramiques	198
Cutters rotatifs	141
Cutters trapèzes	197

D-E-F

Détection	269 > 271
Dévidoirs	48 > 50
Diables	216 > 220
Distributeur de trombones	58
Doigtiers	56
Easy scratch	51
Echelles de réduction KUTCH	95
Educ'ardoise	72
Éléments magnétiques	62 > 63
Épingles	52
Éponges	187
Equerre-rapporteur	96
Escabeaux	211 > 215
Essui-plume	121
Étiquettes	117
Étuis à monnaie	264
Extincteurs	237
Feutres	127 > 128
Fixations	51 > 52
Flûtes	116
Fontaine à eau	186

G-I-L-M-N

Gamme Green	11 > 16
Gels pailletés	136
Gilet de sécurité enfant	116
Globes	108 > 110
Gommes	71
Gommettes	137
Gouache	134
Gourdes	113
Grattoirs	199
I KIT	51
Loupes	111
Machines à tailler	33
Maquette	146
Marchepieds	211
Marqueur textile	136
Marqueurs	158
Matériel de peinture	133
Mètres à ruban	202
MINERVA	97 > 102
Mini imprimante	182
Monnayeurs	263
Notes repositionnables	172 > 173

O-P

Œillets	117
ÔTE-AGRAFES	44
Outils à main	200 > 201
Outils de découpes	143
Outils de jardin	205 > 208
Ouvre-carton	198
Ouvre-lettres	177
Palettes	131
Panneaux collectifs	72
Papiers créatifs	138 > 140
Pâte adhésive	51
Pendules	187
Perforateurs	46 > 47
Perfos déco	147 > 152
Pièces & billets "EURO"	116
Pinceaux	133
Pincés	144
Pincés "bulldog"	61
Pincés "spring clip"	61
Pincés à clip	59
Pincés à dessin	60
Pincés aimantées	62
Pistolet à colle	143
Pistolets à dessin	96

Plaques de coupe	144
Plateaux de transport	228
Plots de marquage	115
Porte-blocs	164 > 165
Porte-clés	278
Porte-marqueurs	158
Porte-mines	122
Porte-parapluies	185
Pots à crayons	175
PROBECO	170 > 171
Punaises	52
R-S	
Registre de sécurité	237
Réglets	202
Relieurs d'archives	58
Repose-pieds	184
Rouleaux ruban adhésifs	50
Rubans adhésifs	204
Sifflets	115
Signalisation	238 > 239
Socles éphémérides	174
Stylo détecteur	269
Stylo-plume	121
Stylo-roller	121
Supports moniteur	183
Surligneurs	120
T-W	
Tableaux	156 > 157
Tabliers de peinture	130 > 131
Tabourets	209 > 210
Taille-crayons	34 > 38
Taille-crayons électrique	33
Tampons de notation	117
Tampons géants	135
Tapis de souris	179 > 180
Thamographe	95
Thermomètres	107
Tiroir-caisse	266
Traçage ALEPH PRO	89
Traçage ALUDIC	88
Traçage ALU'TECH	87
Traçage bois	94
Traçage ECO	93
Traçage ELASTIKA	90
Traçage INCASSABLE	92
Traçage tableaux	84 > 86
Traçage TROMB'LINE	91
Trace courbe flexible	96
Trace-cercles	96

Transpalette	229
Trombones	56 > 58
Trousses	117 > 119
Trousses de secours	233 > 235
Tube à dessin	136
WATT&CO	190 > 191



A-B

Accessories for writing boards	76 > 77
Adhesive	203
Adhesive tape	50
Adhesive tape rolls	204
Archiving binders	58
Ashtrays	185
Badges & accessories	162 > 163
Banknote counters	268
Banknotes and coins accessories	265
Binder clips	60
Blotter sheets	121
Board erasers	160 > 161
Boards	156 > 157
Boards accessories	159
BOLLÉ SAFETY	239
Bottles	113
Brushes	133
Bulldog binder clips	61
Burglary resistant safe	252 > 257
Butterfly paper clips	59
Book cover	145
Brushes	162
Bulldog binder clips	62
Butterfly paper clips	56
C	
Calculators TRULY	103
Carton opener	198
Cash boxes	260 > 262
Cash drawer	266
Ceramic blades cutters	198
Chalks	76
Child safety jacket	116
Circles template	96
Clipboards	164 > 165
Clocks	187
Coin counters	267
Coin trays	263
Coin tubes	264

Collective panels	72
Coloured pencils	125 > 126
Compasses	78 > 83-112
Cones and barrels	114
Connected padlocks	281 > 282
Craft pliers	145
Craft scissors	144
Creative papers	138 > 140
Cutters & blades	192 > 196
Cutting mats	144
Cutting tools	143
D	
Decorative punchers	147 > 152
Deposit safes	246
Desk calendar holders	174
Desktop pencil sharpeners	33
Detection	269 > 271
Detector pen	269
Drawing instruments ALEPH PRO	89
Drawing instruments ALUDIC	88
Drawing instruments ALU'TECH	87
Drawing instruments ECO	93
Drawing instruments ELASTIKA	90
Drawing instruments INCASSABLE	92
Drawing instruments TROMB'LINE	91
E-F	
Easy scratch	51
Eco-friendly products	11 > 16
Educ'ardoise	72
Electric pencil sharpeners	33
Electric stapler	39
Electrical accessories	188 > 189
Emergency box	237
Erasers	71
EURO coins and bank notes	116
Extinguishers	237
Eyelets	117
Fabric marker	136
Felt pens	127 > 128
Fireproof safes 1h	248 > 251
First aid kits	233 > 235
Fixations	51 > 52
Flap folder/wallet/binder	166 > 169
Flat cones	115
Flexible curve trace	96
Footrests	184
Fountain pen	121
French curves	96

G-H-I-K		Pencils pots	175
Gardening tools	205 > 208	Platform carts	228
Giant stamps	135	Platform trolleys	221 > 227
Glitter glue	136	Precision knives	142
Globes	108 > 110	Protactor-square sets	96
Glue gun	143	Punches	46 > 47
Glues	69	R-S	
Gouache	134	Recorders	116
Gouache sticks	127	Reduction scales "KUTCH"	95
Graphite pencils	123	Removable sticky notes	172 > 173
Guns cabinets	259	Rigid tube	136
Hand pallet truck	229	Roller ball pen	121
Hand strapping	203	Rolling stepstools	209 > 210
Hand tools	200 > 201	Rotative cutters	141
Hand trucks	216 > 220	Rubber bands	53 > 55
Heavy duty staplers	39 > 40	Rulers	202
Highlighters	120	Safe cabinets	258
Hotel safes	247	Scales	178
I KIT	51	School scissors	28 > 32
Ink cartridges	121	Scrapers	199
Key box	274	Security register	237
Keys cabinets	272 > 277	Security safes	242 > 245
Keys tags	278	Self-adhesive labels	117
L-M		Sidewalk chalks	137
Letter openers	177	Signalisation	238 > 239
Loose-leaf rings	59	Slates	73 > 75
Magnetic binder clips	62	Sponges	187
Magnetic elements	62 > 63	Spring clip binder	61
Magnets	64 > 68	Staplers	40 > 43
Magnifiers	111	Staples	45
Mailboxes	185	Staples remover	44
Manual foghorn	116	Stepladders	211 > 215
Map pins	52	Stepstools	211
Markers	158	Stickers	137
Measuring board instruments	84 > 86	Stopwatch	115
Measuring tapes	202	T-W	
Mechanical pencils	122	Tack glue dots	51
Medicine cabinets	236	Tacks	52
MINERVA	97 > 102	Tape dispensers	48 > 50
Mini printer	182	Teacher stamps	117
Model	146	Thamographe	95
Monitor holders	183	Thermometers	107
Mouse pad	179 > 180	Thimblettes	56
O-P		Trapezoidal cutters	197
Office accessories	176 > 178	Travel safes	247
Office scissors	19 > 27	TSA Padlocks	281
Padlocks	279 > 282	Umbrella holder	185
Paint pallets	131	Water fountain	186
Painting aprons	130 > 131	Whistles	115
Painting equipment	133	White coats	129
Paper clip dispenser	58	White corrections	70
Paper clipper	59	Wooden drawing instruments	94
Paper clips	56 > 58		
Paper fasteners	52		
Pen holders	158		
Pencil cases	117 > 119		
Pencil grips	123		
Pencil sharpeners	34 > 38		

INDEX NUMÉRIQUE

Numerical index

000040	150	35299	263	900175	172	9036.01	258	APE200062	150
000041	150	35302	263	900176	172	920	106	APE200162	150
000042	24	35303	263	900311	177	9200.01	259	APE200262	150
10404	198	35305	266	900312	177	9200.02	259	APE200362	150
10503	198	35305-12 RT	266	900313	177	9200.03	259	APE200462	150
10513	198	3790	228	900449	122	9608.45	45	APE200662	150
12.7228	270	4010210	58	900450	122	9619.06	41	APE200762	150
13.7164	237	4010410	58	900451	122	9619.45	45	APE200962	150
13.7442	237	4121A	175	900452	122	9623.20	45	APE201062	150
14.7166	200	4121N	175	900453	122	9666.65	45	APE201162	150
14.7167	201	4733	178	900469	58	984418	147	APE400062	151
14.7168	200	511168	187	900471	58	984428	147	APE400162	151
14.7169	201	511209	187	9013.13	254	984438	147	APE400262	151
14.7170	200	570012	117	9013.13 EL	254	984458	147	APE500062	151
14.7171	200	572025	172	9013.19	254	984478	147	APE500162	151
14.7172	200	5760.00	148	9013.19 EL	254	984488	147	APE500362	151
14202-1	265	583460	162	9013.27	254	984498	147	APE500562	151
15002-1	265	584901	176	9013.27 EL	254	984904	147	APE500662	151
153.6	198	662-12	105	9015.07	252	984978	147	APE700062	152
160.1.152 A	198	664435	140	9015.18	252	986004	147	APE700162	152
170141	112	669	105	9015.18 EL	253	986014	147	APE700262	152
215-8	104	67.1.152	198	9015.31	252	986074	147	APE700362	152
216-10	104	766221	208	9015.31 EL	253	986084	147	APE700462	152
216-8	104	790005	95	9015.51	252	986094	147	APE700562	152
24402	275	806B-8	105	9015.51 EL	253	986104	147	APE700662	152
24403	275	812A-12	106	9015.61	252	986114	147	APE780062	149
24404	275	822012	227	9015.61 EL	253	9996.113	270	APE800391	148
24411	275	836B-10	106	9015.78	252	9996.114	271	APE800493	148
24412	275	8470.19 CH	41	9015.78 EL	253	9996.166	271	APE800591	148
24413	275	8470.19 GR	41	9017.46	256	9996.184	270-271	APE800993	148
26510	262	866T-12	106	9017.46 EL	256	9996.224	270-271	APE801593	148
26515	262	880348	150	9017.50	256	9996.328	266	APN100041	133
27201	272	880428	150	9017.50 EL	256	9996.329	266	APN100141	133
27204	274	880528	150	9017.60	256	ACL150091	136	APN100241	133
27401	272	880868	150	9017.60 EL	256	ACL150292	136	APN100341	133
27404	274	880908	150	9017.67	256	ADE010063	145	APN100441	133
27504	274	880958	150	9017.67 EL	256	ADE020063	145	APN100541	133
27801	237	885734	151	9019.55	257	ADE030063	145	APN100641	133
27802	237	889438	149	9019.55 EL	257	ADE040063	145	APN100741	133
28305	274	889908	149	9019.67	257	ADF-16B	190	APN100842	133
283-8	103	889918	149	9019.67 EL	257	ADF-7B	190	APN200042	133
283-8B	103	889928	149	9019.85	257	ADU-9B	190	APN200141	133
283-8G	103	889938	149	9019.85 EL	257	ADY300062	139	APN200241	133
283-8W	103	889948	149	9020.01	251	ADY300162	139	APN200341	133
285	104	900021	278	9021.01	251	ADY300262	139	APN200441	133
289-8	105	900046	203	9022.01	251	ADY300361	139	APN200541	133
32160	95	900050	201	9024.01	251	AOM100082	146	APN200641	133
3320	186	900080	122	9025.01	251	AOM100382	146	APN200741	133
3500-2R	210	900081	122	9033.01	258	AOM100582	146	APN200841	133
35297	263	900082	122	9034.01	258	AOM200071	136	APN200941	133
35298	263	900109	172	9035.01	258	APE150062	150	APN201041	133

APN250061	132	APP200912	137	BCU400172	142	BRE510072	202	FA62291	265
APN250161	132	APP201012	137	BCU400272	142	E102	103 & 178	FA62292	265
APN300041	133	APP900042	140	BCU400372	142	EL18012	90	FA62304	243
APN400092	134	APQ010061	144	BCU400462	143	EL20P	90	FA62305	243
APN400192	134	APQ020061	144	BCU400782	142	EL30	90	FA62323	269
APN450092	134	APQ030061	144	BCU401082	141	EL30P	90	FA62326	268
APN450191	134	APQ100061	144	BCU550082	199	EL36012	90	FA62330 CB	268
APN500022	130	APQ200061	144	BCU550182	199	EL4520	90	FA62335	267
APN500122	130	APQ300061	144	BCU550382	199	EL4530	90	FA62339	242
APN500221	130	APQ400061	144	BES150073	214	EL4535	90	FA62340	242
APN500322	130	ATP100083	135	BES530073	215	EL50	90	FA62341	245
APN500421	130	ATP150083	135	BES533073	213	EL6020	90	FA62342	242
APN500521	130	ATP200083	135	BES543073	213	EL6030	90	FA62344	242
APN500622	130	ATP250083	135	BES553073	213	EL6035	90	FA62345	249
APN500722	130	ATP300083	135	BES563073	213	FA62071	269	FA62346	249
APN500862	131	ATP350083	135	BES573073	213	FA62074	269	FA62348	249
APN500922	130	ATP400083	135	BES580173	215	FA62075	269	FA62349	248
APN550022	131	ATP800083	135	BES583073	213	FA62110	260	FA62351	248
APN900091	132	B 4172.01	198	BES590073	215	FA62113	260	FA62352	255
APN900262	131	B 4196.03	142	BES620073	212	FA62114	261	FA62353	255
APN900361	131	B 4198.16	141	BES720073	212	FA62120	262	FA62354	255
APN900461	131	B 5738.11	151	BES730073	212	FA62121	260	FA62355	255
APN900561	132	B 5738.30	151	BES820073	212	FA62122	261	FA62358 IV	247
APN900661	132	B 5738.69	151	BES830073	212	FA62130	260	FA62360 IV	247
APN900761	136	B 5760.03	149	BF1100002	51	FA62133	261	FA62376	246
APP000002	138	B 5776.40	152	BF1100102	51	FA62137	261	FA62377	246
APP000102	138	B 5776.89	152	BLC090072	193	FA62139	260	FA62378	246
APP050092	140	B 5905.06	132	BLC090171	193	FA62141	260	FA62440	270
APP050102	140	B 5909.01	132	BLC180071	194	FA62142	261	FA62441	271
APP050202	140	BAD150011	208	BLC180171	195-196	FA62146	261	FA62455	270
APP050302	140	BAG100072	200	BLC180272	195-196	FA62149	260	FA62460	270
APP050402	140	BCL110112	143	BLC180372	194	FA62150	260	FA62523	271
APP050502	140	BCL900112	143	BLC180472	196	FA62151	260	FA62530	244
APP050692	140	BCU090062	193	BLC300072	197	FA62158	272	FA62540 N	250
APP050702	140	BCU090282	193	BLC300271	197	FA62164	272	FA62542 N	250
APP100061	146	BCU090372	192	BLC300372	197	FA62170	278	FA62551	274
APP100161	146	BCU090471	192	BLC300472	197 & 199	FA62199	273	FA62739	245
APP100261	146	BCU090572	192	BLC400172	142	FA62200	272	FA62740	245
APP100361	146	BCU090681	192	BLC400272	143	FA62203	272	FA62742	245
APP100461	146	BCU090782	193	BLC400372	141	FA62206	272	FA62744	245
APP100561	146	BCU090862	193	BLC400472	141	FA62261	264	FA62820	273
APP100661	146	BCU180062	196	BLC400572	141	FA62262	264	FA62821	273
APP100761	146	BCU180182	195	BLC400771	142	FA62263	264	FA62822	273
APP100861	146	BCU180282	194	BLC550071	199	FA62264	264	FA62823	273
APP100961	146	BCU180382	194	BME030081	202	FA62266	264	FA62836	274
APP150061	146	BCU180462	196	BME050081	202	FA62268	264	FA62840	273
APP150161	146	BCU180562	196	BME080081	202	FA62270	264	FA62841	273
APP150261	146	BCU180661	195	BME100061	202	FA62271	264	FA62842	273
APP150361	146	BCU180762	195	BME200061	202	FA62272	264	FA62850	273
APP150461	146	BCU180861	196	BPI100082	201	FA62274	264	FA62852	273
APP150561	146	BCU180981	194	BPI100182	201	FA62275	264	FA62853	273
APP150661	146	BCU181082	194	BRE000071	202	FA62276	264	FA62854	273
APP200012	137	BCU181171	195	BRE010071	202	FA62277	264	FA62902	274
APP200112	137	BCU181272	195	BRE020071	202	FA62278	264	FAB100041	174
APP200212	137	BCU181382	195	BRE100072	202	FA62279	264	FAB100161	174
APP200392	137	BCU300082	197	BRE150172	202	FA62280	264	FAB100261	174
APP200412	137	BCU300161	197	BRE200072	202	FA62281	264	FAB100461	174
APP200512	137	BCU300281	197	BRE300072	202	FA62289	265	FAB100561	174
APP200612	137	BCU300382	197	BRE310072	202	FA62290	265	FAB200001	175
APP200712	137	BCU400072	142	BRE500072	202			FAB200101	175

FAB200201	175	FAI090102	68	FAI701071	65	FCG130093	128	FCI172482	22
FAB200301	175	FAI090202	68	FAI701111	63	FCG140092	128	FCI172772	25
FAB200401	175	FAI100092	66	FAI701211	64	FCG140193	128	FCI173062	11 et 20
FAB200591	175	FAI100102	66	FAI701311	64	FCG510092	127	FCI190182	24
FAB200601	175	FAI100302	66	FAI701411	64	FCG510193	127	FCI190382	23
FAB280003	175	FAI100402	66	FAI701512	138	FCI100061	32	FCI190481	27
FAD000011	50	FAI100791	66	FAI701711	63	FCI100161	32	FCI200071	25
FAD000211	50	FAI140171	65	FAI800011	63	FCI110061	32	FCI200171	25
FAD100011	50	FAI150092	66	FAR000041	75	FCI110172	27	FCI210182	24
FAD100111	50	FAI150102	66	FAR000161	75	FCI120061	31	FCI210282	22
FAD100211	50	FAI150202	66	FAR000341	74	FCI120162	31	FCI210382	19
FAD100311	50	FAI150302	66	FAR090192	77	FCI120251	31	FCI210482	21
FAD100411	50	FAI150502	66	FAR100041	74	FCI120352	31	FCI210862	21
FAD100611	50	FAI150691	66	FAR100141	74	FCI120462	28	FCI210961	23
FAD100911	50	FAI200092	66	FAR100241	75	FCI130081	24	FCI211061	26
FAD101111	50	FAI200102	66	FAR100341	75	FCI130181	30	FCI211162	26
FAD101213	48 & 50	FAI200202	66	FAR100441	75	FCI130182	30	FCI211261	26
FAD500012	51	FAI200302	66	FAR200061	75	FCI130281	22	FCI211362	26
FAD900062	49	FAI200502	66	FAR200441	75	FCI130282	22	FCI211452	26
FAD900191	49	FAI200691	66	FAR300162	73	FCI130352	30	FCI211662	21
FAD900261	50	FAI200891	66	FAR300261	73	FCI130481	11 & 29	FCI211861	21
FAD900363	49	FAI250092	66	FAR300341	74	FCI130781	29	FCI211962	11 & 20
FAD900563	49	FAI250102	66	FAR400162	73	FCI130881	29	FCI212682	22
FAD900691	50	FAI250202	66	FAR400361	73	FCI130961	32	FCI212782	22
FAD950062	49	FAI250302	66	FAR400461	73	FCI131061	28	FCI212882	21
FAD950162	48	FAI250402	66	FAR500071	74	FCI131161	28	FCI212982	23
FAF080073	45	FAI250502	66	FAR500171	74	FCI131261	32	FCI213062	11 et 20
FAF080173	45	FAI250691	66	FAR900091	77	FCI131362	32	FCI230082	145
FAF100073	45	FAI300092	67	FAR900291	77	FCI131451	32	FCI230182	19
FAF100173	45	FAI300102	67	FAR900392	77	FCI132161	29	FCI230462	19
FAF230073	45	FAI300202	67	FAR900442	77	FCI132251	29	FCI250062	19
FAF230173	45	FAI300302	67	FAR900542	77	FCI132381	30	FCI900063	31
FAF230273	45	FAI300502	67	FAR900722	77	FCI132482	22	FCL100113	12 & 69
FAF240073	45	FAI300691	67	FAR900841	77	FCI132582	21	FCL200113	12 & 69
FAF240173	45	FAI320092	67	FAS100071	113	FCI133262	11 & 20	FCL400113	12 & 69
FAF260073	45	FAI320102	67	FAS100173	113	FCI150182	24	FCL720012	69
FAF260173	45	FAI320202	67	FCG000092	126	FCI150281	30	FCL720112	69
FAF260273	45	FAI320302	67	FCG000192	126	FCI150382	30	FCM100061	169
FAG080082	42	FAI320402	67	FCG000293	126	FCI150452	30	FCM100161	169
FAG080262	42	FAI400092	67	FCG000393	126	FCI150561	31	FCM100261	169
FAG100062	43	FAI400191	64	FCG000492	125	FCI150662	31	FCM100361	169
FAG100162	43	FAI400291	64	FCG000502	125	FCI150761	32	FCM100461	169
FAG100272	43	FAI400302	67	FCG000602	125	FCI160082	22	FCM100561	169
FAG100362	40	FAI400491	67	FCG000702	125	FCI160161	27	FCM150061	169
FAG100482	42	FAI400502	67	FCG000802	125	FCI170182	24	FCM150161	169
FAG100573	42	FAI500002	68	FCG000902	125	FCI170282	19	FCM150261	169
FAG100883	42	FAI500102	68	FCG001002	125	FCI170382	21	FCM150361	169
FAG240082	43	FAI500202	68	FCG001102	125	FCI170662	27	FCM150461	169
FAG240162	43	FAI500302	68	FCG001202	125	FCI170761	23	FCM150561	169
FAG240382	42	FAI510002	68	FCG001302	125	FCI170861	26	FCM150661	169
FAG240462	41	FAI510102	68	FCG001402	125	FCI170962	26	FCM200061	166
FAG240563	39	FAI510402	68	FCG001502	125	FCI171061	26	FCM200161	169
FAG240762	43	FAI510602	68	FCG001602	125	FCI171162	26	FCM200261	169
FAG260072	207	FAI700111	63	FCG001793	125	FCI171252	26	FCM200361	169
FAG300073	40	FAI700213	63	FCG010092	126	FCI171362	21	FCM200461	169
FAG300173	40	FAI700362	62	FCG110092	128	FCI171571	25	FCM200501	168
FAG500083	39	FAI700472	62	FCG110193	128	FCI171671	25	FCM200601	168
FAG500183	39	FAI700672	62	FCG110292	127	FCI171772	27	FCM200701	168
FAG600063	41	FAI700772	62	FCG120092	128	FCI172162	11 & 20	FCM200801	168
FAI060092	65	FAI700872	62	FCG120192	127	FCI172382	22	FCM200901	168

FCM201001	168	FCR350163	71	FEL040103	54	FFI050073	52	FOP550563	109
FCM201101	168	FCR350461	71	FEL060002	54	FFI050173	52	FOP550663	108
FCM201201	168	FCR600063	71	FEL060103	54	FFI050273	52	FOP550763	108
FCM201301	168	FDB100061	31	FEL070002	54	FFI050572	52	FOP550863	108
FCM201401	168	FEC050062	122	FEL070103	54	FFI050672	52	FOP550963	108
FCM201501	168	FEC070062	122	FEL070202	54	FFI050872	52	FOP551063	108
FCM201601	168	FEC090042	123	FEL080002	54	FFI050972	52	FOP551163	108
FCM201701	168	FEC100642	123	FEL080103	54	FFI060073	58	FOP551263	108
FCM201801	168	FEC100742	123	FEL090002	54	FFI100073	59	FOP551363	108
FCM201901	168	FEC100842	123	FEL090103	54	FFI100173	59	FOP551463	109
FCM202001	15 & 168	FEC101242	123	FEL090202	54	FFI100272	59	FOP600092	117
FCM202101	15 & 168	FEC120342	123	FEL090303	54	FFI500092	51	FOP600192	117
FCM300061	169	FEC130042	123	FEL090402	54	FFT000061	119	FOP800071	115
FCM300161	169	FEC140042	123	FEL090503	54	FFT000121	118	FOP800462	116
FCM300261	169	FEC150242	76	FEL100002	54	FFT000221	118	FOP800562	115
FCM400061	166	FEC200061	121	FEL100103	54	FFT150021	118	FOP800662	116
FCM400161	166	FEC210063	121	FEL100202	54	FFT200021	119	FOP800762	116
FCM400261	166	FEC300002	121	FEL100402	54	FFT200121	118	FOT010061	44
FCM400401	15 & 167	FEC300202	121	FEL110002	54	FFT200221	13 & 119	FOT010162	44
FCM400501	15 & 167	FEC310062	70	FEL110103	54	FFT200321	13 & 119	FOT020072	44
FCM400601	15 & 167	FEC400192	13 & 120	FEL120002	55	FFT300101	119	FPE010072	47
FCM400701	15 & 167	FEC400403	13 & 120	FEL120103	55	FFT300201	119	FPE020072	47
FCM700061	166	FEC400492	120	FEL120202	55	FFT300301	119	FPE020172	46
FCM700101	15 & 167	FEC400503	13 & 120	FEL120303	55	FFT300401	119	FPE020273	46
FCM700201	15 & 167	FEC400603	13 & 120	FEL120402	55	FFT300501	119	FPE020372	46
FCM900093	168	FEC400703	13 & 120	FEL150002	55	FFT300601	119	FPE020472	46
FCO100162	78	FEC410003	120	FEL150103	55	FFT400021	118	FPE020662	47
FCO100272	82	FEC410103	120	FEL150202	55	FFT500121	117	FPE040072	47
FCO100562	78	FEC410203	120	FEL150402	55	FIM000062	107	FPE040172	46
FCO100761	79	FEC410303	120	FEL150503	55	FIM000162	107	FPI000073	61
FCO100872	78	FEC410492	120	FEL150602	55	FLO100082	111	FPI000172	61
FCO100961	78	FEC410503	120	FEL180002	55	FLO100102	111	FPI040073	61
FCO101062	79	FEC500192	158	FEL180103	55	FLO100202	111	FPI040172	61
FCO101161	78	FEC520032	136	FEL180202	55	FLO100302	111	FPI190073	60
FCO101202	79	FEC530031	158	FEL180303	55	FLO100472	111	FPI190172	60
FCO101561	78	FEC530132	158	FEL200002	55	FLO100572	111	FPI190273	60
FCO200073	80	FEC530232	158	FEL200103	55	FLO100672	111	FPI190372	60
FCO200172	81	FEC650002	76	FEL200202	55	FLO100772	111	FPI200073	61
FCO200272	81	FEC650192	76	FEL200303	55	FOP000062	112	FPI200172	61
FCO200372	81	FEC650203	76	FEL200402	55	FOP000162	112	FPI250073	60
FCO200672	81	FEC650393	76	FEL200503	55	FOP000361	112	FPI250172	60
FCO200772	82	FEC700092	137	FEL250093	53	FOP000461	112	FPI300073	61
FCO200961	79	FEC700192	137	FEL250193	53	FOP000561	112	FPI300172	61
FCO201171	80	FEC700293	137	FEL250293	53	FOP100261	72	FPI300212	62
FCO201362	79	FEC700393	137	FEL250393	53	FOP100361	72	FPI320073	60
FCO201472	80	FEC700493	137	FFI000073	52	FOP100461	72	FPI320172	60
FCO300072	82	FEC700593	137	FFI000173	52	FOP100761	72	FPI410073	60
FCO300172	82	FEC900061	76	FFI000293	52	FOP200062	115	FPI410172	60
FCO300272	83	FEC900161	123	FFI000373	52	FOP300091	116	FPI500073	61
FCO300372	83	FEC900263	123	FFI000493	52	FOP300191	116	FPI500172	61
FCO300572	83	FEC900361	123	FFI000592	52	FOP300291	116	FPI500212	62
FCO900062	80	FEC900461	123	FFI000672	52	FOP500263	110	FPI510073	60
FCR040092	70	FEC900622	121	FFI000872	52	FOP500363	110	FPI510172	60
FCR080002	70	FEL000092	53	FFI000892	52	FOP500463	110	FPI600073	61
FCR080102	70	FEL000193	53	FFI010073	52	FOP500563	110	FPI600172	61
FCR120002	13 & 70	FEL000292	53	FFI010292	52	FOP550063	110	FPI700073	61
FCR200021	70	FEL000392	53	FFI020072	59	FOP550163	110	FPI700172	61
FCR300063	71	FEL000593	53	FFI020272	59	FOP550263	110	FPI800162	59
FCR300263	71	FEL000692	53	FFI020472	59	FOP550363	109	FPI900272	59
FCR350062	71	FEL040002	54	FFI020672	59	FOP550463	109	FPP100092	172

FPP100192	173	FTA600161	86	FTC251601	34	FTS850062	92	GAD900063	49
FPP100301	172	FTA600261	86	FTC350063	35	FTS850262	14 & 91	GAD900263	203
FPP100401	172	FTA610041	84	FTC500071	33	FTT000171	87	GAD900383	203
FPP100501	172	FTA610161	84	FTC510071	33	FTT000271	143	GAE000062	188
FPP100601	172	FTA800041	85	FTC900041	38	FTT030072	88	GAE000162	188
FPP100701	172	FTA800161	86	FTC900071	33	FTT170162	89	GAE000362	188
FPP200112	173	FTA800261	86	FTC900271	33	FTT170362	89	GAE000462	188
FPP200212	173	FTA810041	84	FTC900361	33	FTT200072	87	GAE000562	189
FPP300012	173	FTA810161	84	FTE040062	93	FTT200172	88	GAE000662	189
FPP300112	173	FTA910061	84	FTE160093	94	FTT210162	89	GAE100162	188
FPP300212	173	FTB250073	57	FTE200062	93	FTT220072	87	GAE100262	188
FPP400012	172	FTB250173	57	FTE220062	93	FTT300072	87	GAE100362	188
FPP400112	172	FTB250273	57	FTE300062	93	FTT300172	88	GAE100462	188
FPP400411	172	FTB250373	57	FTE330062	93	FTT300271	143	GAE300062	188
FPP500012	117	FTB250593	57	FTE400062	93	FTT330072	87	GAE300162	188
FPP550092	117	FTB250693	57	FTE500062	93	FTT400072	87	GAE300262	188
FPP550102	117	FTB250772	57	FTE700062	93	FTT400172	88	GAE400062	189
FSC000013	157	FTB250892	57	FTE700162	93	FTT400271	143	GAE500061	189
FSC000213	157	FTB250992	57	FTE750062	93	FTT500072	87	GAE500161	189
FSC000311	157	FTB300073	57	FTE750162	93	FTT500172	88	GAE900163	189
FSC000411	157	FTB300173	57	FTE850062	93	FTT500271	143	GAE900263	189
FSC000711	157	FTB300273	57	FTE860062	93	FTT510061	96	GBU100033	186
FSC000811	62	FTB300373	57	FTN000062	96	FTT600072	87	GBU200063	186
FSC000911	62	FTB300472	57	FTN050062	96	FTT600271	143	GCE000063	203
FSC100083	156	FTB320073	57	FTN350062	95	FTT700072	87	GEQ000001	185
FSC100183	156	FTB320173	57	FTN350162	95	FTT700172	88	GEQ000101	185
FSC100283	156	FTB320273	57	FTN350262	95	FTT700262	96	GEQ100073	185
FSC200073	157	FTB320373	57	FTN350362	95	FTT700362	96	GEQ100173	185
FSC200173	157	FTB320593	57	FTN350462	95	FTT750072	87	GEQ100273	185
FSC200273	157	FTB320672	57	FTN350562	95	FTT750172	88	GEQ200071	185
FSC300043	156	FTB320693	57	FTP100083	176	FTT800271	143	GEQ900071	185
FSC300143	156	FTB450073	57	FTP100181	176	FTT850072	87	GER200063	183
FSC400073	156	FTB500073	56	FTP200001	176	FTT850172	88	GER200163	183
FSC600041	159	FTB500192	57	FTP200101	176	FTT860162	89	GER200263	183
FSC600141	161	FTB770073	56	FTP200201	176	FTT860362	89	GER200363	183
FSC600261	161	FTB900062	58	FTP300033	176	FTT870141	94	GER200463	183
FSC600362	160	FTB900163	58	FTP300133	176	FTT870272	87	GER300022	179
FSC650062	160	FTC100073	37	FTP300233	176	FTT870372	87	GER300122	179
FSC650162	16 & 160	FTC100173	37	FTS040062	92	FZZ100061	177	GER300222	179
FSC650361	160	FTC100461	38	FTS040262	14 & 91	FZZ100162	177	GER310022	179
FSC650462	16 & 160	FTC100563	38	FTS200062	92	FZZ100261	177	GER330063	179
FSC700022	160	FTC100681	37	FTS200262	14 & 91	FZZ100362	177	GER340063	180
FSC700122	160	FTC100972	37	FTS220062	92	FZZ100461	177	GER340163	180
FSC700162	160	FTC150063	33	FTS220241	94	FZZ100562	177	GER400063	184
FSC800013	16 & 158	FTC150163	33	FTS220362	14 & 91	FZZ200062	177	GER400163	184
FSC800112	16 & 158	FTC150281	37	FTS300062	92	GAD100011	204	GEX000003	56
FSC900031	159	FTC150483	12 & 36	FTS300241	94	GAD200011	204	GEX100003	56
FTA000041	85	FTC200073	37	FTS300362	14 & 91	GAD200111	204	GEX110003	56
FTA000141	85	FTC200361	38	FTS330062	92	GAD300011	204	GEX120003	56
FTA000261	86	FTC250063	36	FTS330262	14 & 91	GAD300111	204	GHO010062	187
FTA000361	86	FTC250163	36	FTS400062	92	GAD400011	204	GHO010162	187
FTA010041	84	FTC250263	36	FTS400262	14 & 91	GAD400111	204	GID200061	162
FTA010161	84	FTC250371	34	FTS500062	92	GAD400211	204	GID200162	162
FTA100041	85	FTC250461	34	FTS700062	92	GAD400311	204	GID300061	162
FTA200041	85	FTC250571	34	FTS700162	92	GAD700011	204	GID300161	162
FTA250041	85	FTC250762	35	FTS700462	14 & 91	GAD700111	204	GID300362	162
FTA250141	85	FTC250863	34	FTS750062	92	GAD700311	204	GID400061	163
FTA250361	86	FTC250961	34	FTS750162	92	GAD750001	204	GID400181	163
FTA300061	86	FTC251071	34	FTS750541	94	GAD750101	204	GID600061	162
FTA600041	85	FTC251281	35	FTS750662	14 & 91	GAD800011	16 & 204	GID900021	163

GIP000063	182	LBP50	178	MCH501171	223	P10101PP	170	SEP200021	129
GIP900003	182	M79352400	100	MCH501471	221	P10108	170	SEP210021	129
GPB030061	165	M79352401	99	MCH501671	223	P10141PP	170	SEP220021	129
GPB040071	164	M79352402	99	MCH900361	226	P10161PP	170	SEP230021	129
GPB040171	164	M79352403	100	MCH900461	226	P10168	170	SEP240021	129
GPB040261	164	M79352404	99	MCH900561	228	P11107	170	SEP300021	129
GPB040361	165	M79352405	99	MCH900771	222-225-227	P11147	170	SEP310021	129
GPB040441	164	M79352406	100	MCH900871	222-225-227	P11189	170	SEP320021	129
GPB140061	164	M79352407	100	MCH900971	222 & 224	P13101PP	170	SEP330021	129
GPB140161	165	M79352408	99	MCH901071	222 & 224	P14309	170	SEP340021	129
GPB140261	164	M79352409	99	MCH901171	227	P15102	170	SEP800022	116
GPB140361	164	M79352410	99	MCH901271	227	P15109	170	SPV010021	238
GPB140461	164	M79352412	101	MCH901361	221	P15159	170	SPV010121	238
GPB240061	165	M79352413	101	MCH901461	221	P16107	171	SPV010221	238
GPN100062	161	M79352416	99	MCH901561	221	P16147	171	SPV100161	238
GTM100003	210	M79352417	99	MCH901661	221	P16157	171	SPV200061	239
GTM100103	210	M79352418	97	MCH901761	223	P16179	171	SPV200161	239
GTM100203	210	M79352419	97	MCH901861	223	P16189	171	SPV200261	238
GTM150003	210	M79352420	97	MCH901961	223	P16227	171	SPV200361	238
GTM150103	210	M79352421	97	MCH902061	223	P16259	171	SX53-1	199
GTM150203	209	M79352422	98	MCH902161	224	P2010001	171	UP00252	278
GTM150303	209	M79352423	98	MCH902261	224	P20121	171	UP00253	278
GTM150403	209	M79352424	99	MCH902761	186	P20128	171	UP00254	278
GTM200003	209	M79352425	99	MDI100071	216	P30102	171	UP00255	278
GTM200103	209	M79352426	99	MDI100171	217	P30105	171	UP00256	278
GTM200203	209	M79352427	97	MDI100271	216	P40100	171	UP00257	278
GTM200303	209	M79352439	101	MDI100371	216	P40150	171	UP00258	278
GTM200403	209	M79352440	98	MDI100571	217	P40200	171	UP00259	278
GTM320073	211	M79352441	102	MDI100671	217	P40250	171	UP00260	278
HBP900	178	M79352444	100	MDI200071	219	P60500	171	UP00261	278
IM21761	276	M79352446	100	MDI200171	219	P63250	171	UP00262	278
IM21763	276	M79352447	100	MDI200271	220	PRO E-200	178	UP00263	278
IM21764	276	M79352448	101	MDI200371	220	PSSBL30-014	239	UP00269	278
IM21771	277	M79352449	101	MDI200471	219	SAV1102	244	UP00275	278
IM21772	277	M79352450	101	MDI200571	218	SAV1103	249	UP00281	278
IM21773	277	M79352451	101	MDI200671	218	SAV1104	247	UP00282	278
IM50001	236	M79352452	101	MDI900061	216	SCD210072	280	UP00410	278
IM50002	236	M79352454	102	MDI900161	218	SCD220071	280	UP00425	278
IM50003	236	M79352455	102	MDI900261	220	SCD220372	280	WAD130101	208
IM50004	236	M79352456	102	MDI900361	219	SCD300072	279	WCI190062	206
IM50010	235	M79352457	102	MDI900461	219	SCD300171	279	WCI200082	206
IM50502	233	M79352458	97	MDI900561	219	SCD300372	279	WDN100071	207
IM50505	235	M79352460	98	MDI900661	220	SCD310072	280	WSE100062	207
IM50506	234	M79352470	97	MP-DUETWO-GR-B	191	SCD340272	281	WSE250063	207
IM50511	233	M79352477	97	MPF2C-RO-CT	190	SCD340372	281	WSM100062	206
IM80026	276	MCH100041	228	MPF3C-BL-CT	190	SCD400072	279	WST100082	205
IM80027	276	MCH100241	226	MPF3C-BL-CT	190	SCD400171	279	WST200062	205
IM80029	276	MCH300071	227	MPF3C-BL-CT	190	SCD400271	279	WST200182	205
JSP050161	115	MCH300171	227	MPF3C-GR-CT	190	SCD400472	279	WST200282	205
JSP180161	115	MCH400071	226	MPF3C-TU-CT	190	SCD490072	280		
JSP230161	115	MCH400171	226	MPF6-B	191	SCD620072	280		
JSP300161	114	MCH500071	224	MP-TWISTER	191	SCD630072	280		
JSP400161	114	MCH500171	222	MPWATTBALL-BL-CT	191	SCD760072	282		
JSP500161	114	MCH500271	223	MPWATTBALL-GR-CT	191	SCD760172	282		
JSP900161	114	MCH500571	222	MTL100171	229	SCD760272	282		
JSP900261	114	MCH500671	221	N506132	187	SCD860072	281		
JSP900361	114	MCH500771	225	N508083	187	SEP000021	129		
K60300	266	MCH500871	222	N-REG-U100	237	SEP010021	129		
LP-160	159	MCH500971	225	OVLITLPSI	239	SEP020021	129		
		MCH501071	225			SEP030021	129		

Wonday[®]

creative tools for school and business



wonday.com



WONDAY

Parc d'activités « Entre Dore et Allier »
Allée des acacias - 63190 LEZOUX - France

Tél. +33 (0)4 73 61 20 68
contact@wunday.com - www.wunday.com

